

87666-2 ✓ ACTIVE

AMPMODU | AMPMODU IV/V

TE Internal #: 87666-2

Socket Contact, Gold, 250 VAC, Discrete Wire, 26 – 22 AWG Wire Size, .12 – .4 mm<sup>2</sup> Wire Size, 236.823 – 789.41 CMA Wire Size, Crimp, AMPMODU IV/V

[View on TE.com >](#)



Connectors > Contacts > Connector Contacts

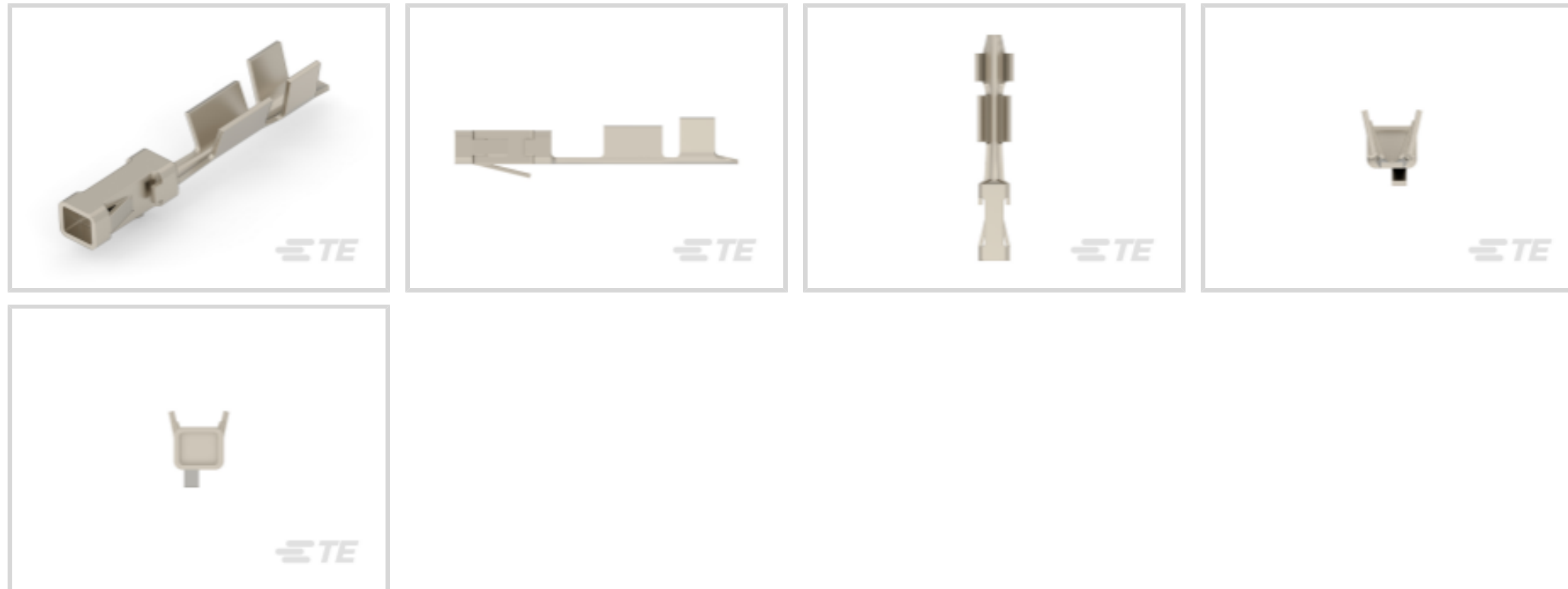

Contact Type: **Socket**

Contact Mating Area Plating Material: **Gold**

Wire Contact Termination Area Plating Material: **Gold Flash**

Operating Voltage: **250 VAC**

Compatible With Wire & Cable Type: **Discrete Wire**

## Features

### Product Type Features

Applied Pressure	Standard
------------------	----------

### Configuration Features

Compatible With Wire & Cable Type	Discrete Wire
-----------------------------------	---------------

### Electrical Characteristics

Termination Resistance	12 mΩ
Insulation Resistance	5000 MΩ
Dielectric Withstanding Voltage (Max)	750 V
Operating Voltage	250 VAC

### Contact Features

Mating Square Post Dimension	.64 mm[.025 in]
Contact Type	Socket
Contact Mating Area Plating Material	Gold
Wire Contact Termination Area Plating Material	Gold Flash
Contact Base Material	Beryllium Copper



Contact Current Rating (Max)	3 A
------------------------------	-----

### Termination Features

Termination Method to Wire & Cable	Crimp
Product Terminates To	Wire & Cable

### Mechanical Attachment

Wire Insulation Support	With
-------------------------	------

### Dimensions

Wire Size	236.823 – 789.41 CMA
-----------	----------------------

### Usage Conditions

Operating Temperature Range	-65 – 105 °C[-85 – 221 °F]
-----------------------------	----------------------------

### Operation/Application

Circuit Application	Power & Signal
---------------------	----------------

### Industry Standards

Compatible With Approved Standards Products	CSA LR7189, UL E28476
---	-----------------------

### Packaging Features

Packaging Quantity	12500
Packaging Method	Reel

## Product Compliance

[For compliance documentation, visit the product page on TE.com>](#)

EU RoHS Directive 2011/65/EU	Compliant
EU ELV Directive 2000/53/EC	Compliant
China RoHS 2 Directive MIIT Order No 32, 2016	No Restricted Materials Above Threshold
EU REACH Regulation (EC) No. 1907/2006	Current ECHA Candidate List: JUNE 2023 (235) Candidate List Declared Against: JUNE 2023 (235) Does not contain REACH SVHC
Halogen Content	Low Halogen - Br, Cl, F, I < 900 ppm per homogenous material. Also BFR/CFR/PVC Free
Solder Process Capability	Not applicable for solder process capability

Product Compliance Disclaimer

This information is provided based on reasonable inquiry of our suppliers and represents our current actual knowledge based on the information they provided. This information is subject to change. The part numbers that TE has identified as EU RoHS compliant have a maximum concentration of 0.1% by weight in homogenous materials for lead, hexavalent chromium, mercury, PBB, PBDE, DBP, BBP, DEHP, DIBP, and 0.01% for cadmium, or qualify for an exemption to these limits as defined in the Annexes of Directive 2011/65/EU (RoHS2). Finished electrical and electronic equipment products will be CE marked as required by Directive 2011/65/EU. Components may not be CE marked. Additionally, the part numbers that TE has identified as EU ELV compliant have a maximum concentration of 0.1% by weight in homogenous materials for lead, hexavalent chromium, and mercury, and 0.01% for cadmium, or qualify for an exemption to these limits as defined in the Annexes of Directive 2000/53/EC (ELV). Regarding the REACH Regulation, the information TE provides on SVHC in articles for this part number is based on the latest European Chemicals Agency (ECHA) 'Guidance on requirements for substances in articles' posted at this URL: <https://echa.europa.eu/guidance-documents/guidance-on-reach>

## Compatible Parts



TE Part # 91517-1  
CCII FEMALE MOD IV REC 24-22 ASSY



TE Part # 1-87499-7  
10 MODIV HSG SR MRKD .100CL



TE Part # 1-102387-2  
64 MODIV HSG COMP DR .100 POL



TE Part # 1-87631-2  
16 MODIV HSG DR MRKD .100 POL



TE Part # 87499-7  
04 MODIV HSG SR MRKD .100CL



TE Part # 1-87456-5  
20 MODIV HSG COMP DR .100CL



TE Part # 1-87631-6  
20 MODIV HSG DR MRKD .100 POL



TE Part # 1-102387-0  
50 MODIV HSG COMP DR .100 POL



TE Part # 87977-8  
20 MODIV HSG DR MRKD .100 POL



TE Part # 102241-6  
08 MODIV HSG COMP SR .100 POL



TE Part # 87977-4  
12 MODIV HSG DR MRKD .100 POL



TE Part # 102387-7  
30 MODIV HSG COMP DR .100 POL



TE Part # 1-87499-0  
05 MODIV HSG COMP SR .100CL



TE Part # 87631-6  
10 MODIV HSG DR MRKD .100 POL



TE Part # 87499-4  
02 MODIV HSG COMP SR .100CL



TE Part # 87456-6  
10 MODIV HSG DR MRKD .100CL





TE Part # 102387-6  
26 MODIV HSG COMP DR .100 POL



TE Part # 102387-9  
40 MODIV HSG COMP DR .100 POL



TE Part # 87456-1  
06 MODIV HSG COMP DR .100CL



TE Part # 102387-4  
20 MODIV HSG COMP DR .100 POL

Also in the Series | AMPMODU IV/V

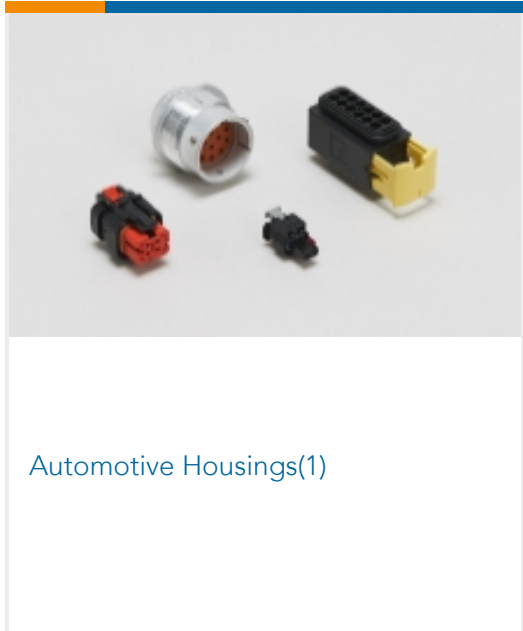

Automotive Housings(1)

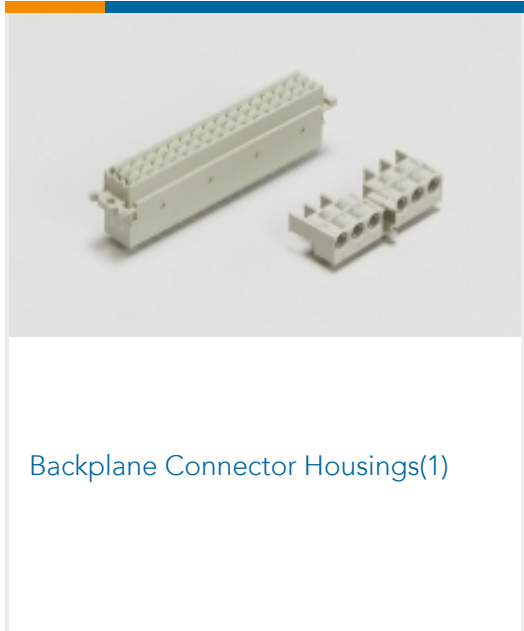

Backplane Connector Housings(1)



Connector Caps & Covers(18)

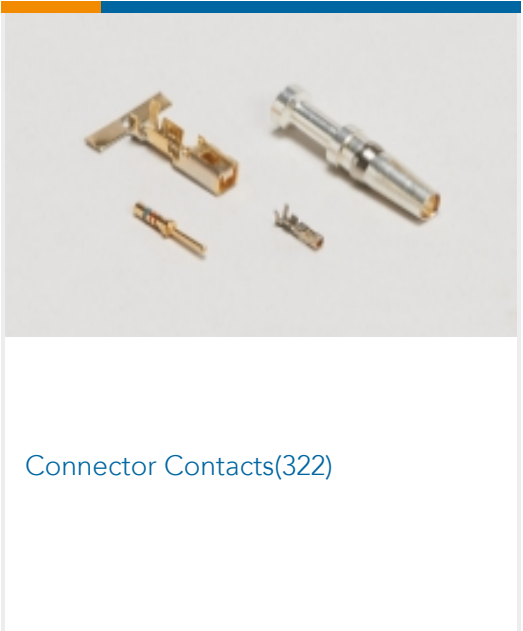

Connector Contacts(322)



Connector Hardware(13)

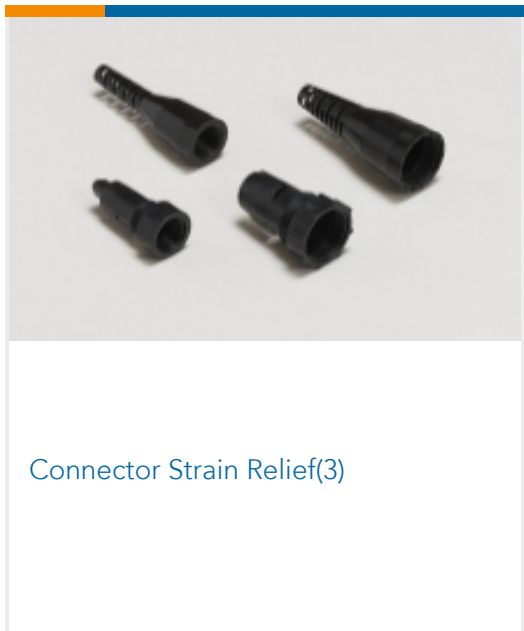

Connector Strain Relief(3)

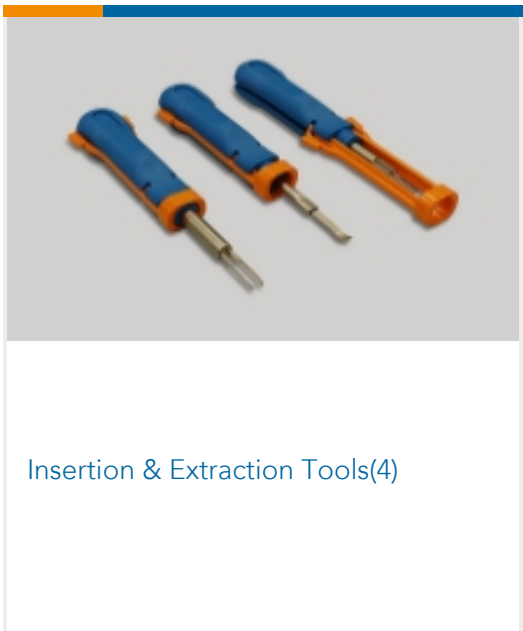

Insertion & Extraction Tools(4)



PCB Headers & Receptacles(931)

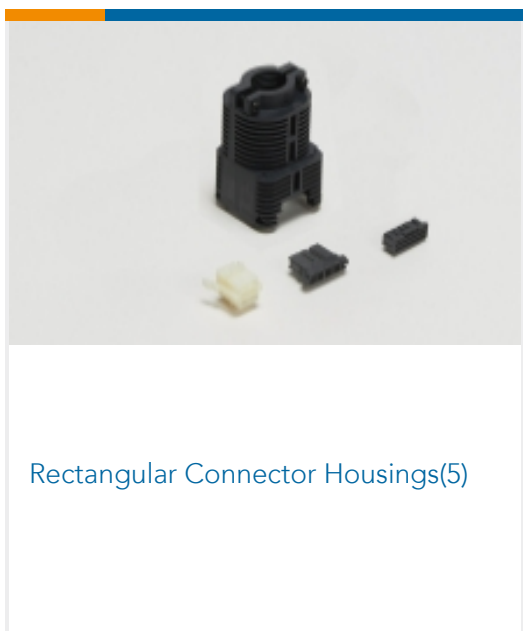

Rectangular Connector Housings(5)

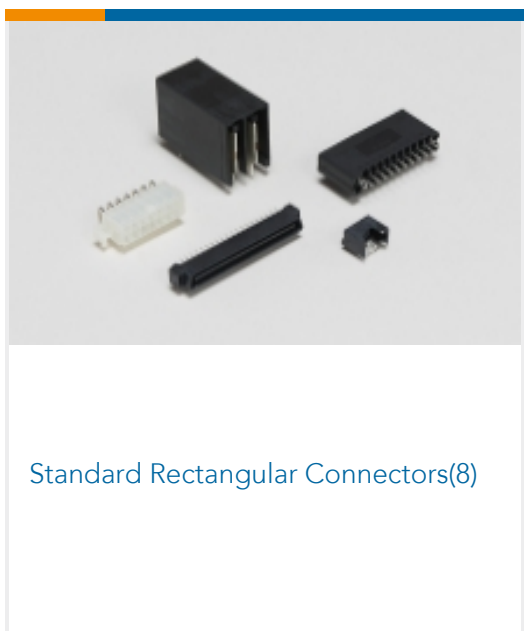

Standard Rectangular Connectors(8)

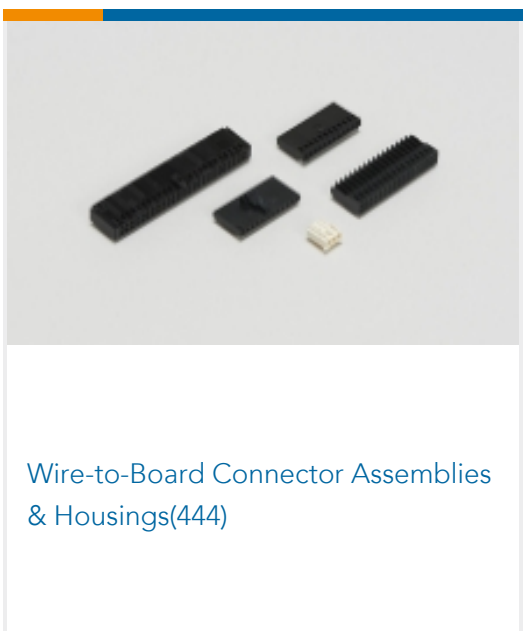

Wire-to-Board Connector Assemblies & Housings(444)

Customers Also Bought



TE Part #3-644043-6  
06P MTA100 CONN ASSY LF



TE Part #2-179694-9  
2MM CT MT REC ASSY 9P GRAY



TE Part #1623731-1  
BCHE 5 W 10K 5%



TE Part #1879447-5  
TE 200W 2R2 5% Bracket



TE Part #556879-8  
PLUG HSG, AMPINNERGY WTB, 8 POS



TE Part #102241-4  
06 MODIV HSG COMP SR .100 POL

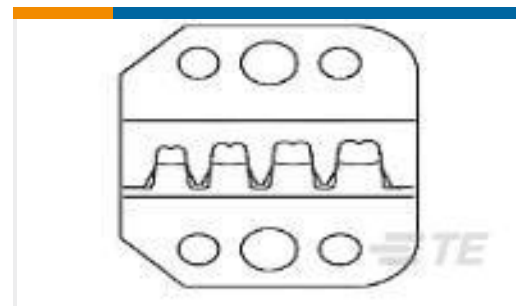

TE Part #90800-2  
DIE ASSEMBLY



TE Part #1241872-1  
JPT A REC 2.8 Contact SWS Sn



TE Part #34114  
SOLIS R 22-16COMM22-18MIL 5/16



TE Part #1SNA176672R0100  
BJM8-5

## Documents

### Product Drawings

[MOD IV RECP PLTD 30 SEL](#)

English

### CAD Files

[3D PDF](#)

3D

Customer View Model

[ENG\\_CVM\\_CVM\\_87666-2\\_AH.2d\\_dxf.zip](#)

English

Customer View Model

[ENG\\_CVM\\_CVM\\_87666-2\\_AH.3d\\_igs.zip](#)

English

Customer View Model

[ENG\\_CVM\\_CVM\\_87666-2\\_AH.3d\\_stp.zip](#)

English

By downloading the CAD file I accept and agree to the [Terms and Conditions](#) of use.

### Datasheets & Catalog Pages

[AMP MODU IV & V Section of Catalog 1307819](#)

English

[AMPMODU\\_INTERCONNECTION\\_SYSTEM\\_SECTION5\\_CONT](#)

English

### Product Specifications

[Application Specification](#)

English

87666-2

Socket Contact, Gold, 250 VAC, Discrete Wire, 26 – 22 AWG Wire Size, .12 – .4 mm<sup>2</sup>  
Wire Size, 236.823 – 789.41 CMA Wire Size, Crimp, AMPMODU IV/V

