

Dual/Quad, 400kHz, Ultra-Low Power Operational Amplifiers

November 1996

Features

- **Low Supply Current** 45 μ A/Amp
- **Wide Supply Voltage Range Single** 3V to 30V
or Dual $\pm 1.5V$ to $\pm 15V$
- **High Slew Rate** 1.5V/ μ s
- **High Gain** 100kV/V
- **Unity Gain Stable**
- **Available in Duals and Quads**

Applications

- **Portable Instruments**
- **Meter Amplifiers**
- **Telephone Headsets**
- **Microphone Amplifiers**
- **Instrumentation**
- **For Further Design Ideas See Application Note 544**

Description

The HA-5142/44 ultra-low power operational amplifiers provide AC and DC performance characteristics similar to or better than most general purpose amplifiers while only drawing 1/30 of the supply current of most general purpose amplifiers. In applications which require low power dissipation and good AC electrical characteristics, this family offers the industry's best speed/power ratio.

The HA-5142/44 provides accurate signal processing by virtue of their low input offset voltage (2mV), low input bias current (45nA), high open loop gain (100kV/V) and low noise (20nV/ \sqrt Hz), for low power operational amplifiers. These characteristics coupled with a 1.5V/ μ s slew rate and a 400kHz bandwidth make the HA-5142/44 ideal for use in low power instrumentation, audio amplifier and active filter designs. The wide range of supply voltages (3V to 30V) also allow these amplifiers to be very useful in low voltage battery powered equipment. These parts are also tested and guaranteed at both $\pm 15V$ and single ended +5V supplies.

These amplifiers are available with industry standard pinouts which allow the HA-5142/5144s to be interchangeable with most other operational amplifiers. For military grade product refer to the 5142, 5144/883 data sheet.

Pinouts (See Ordering Information on Next Page)

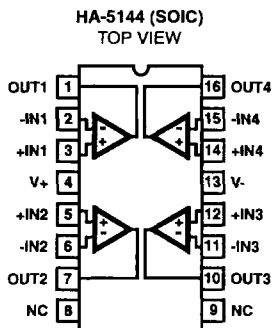
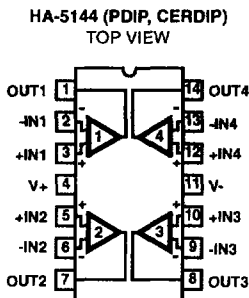
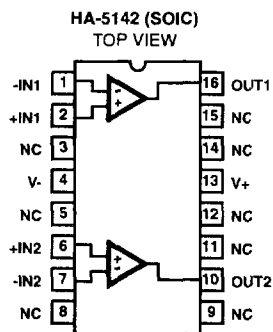
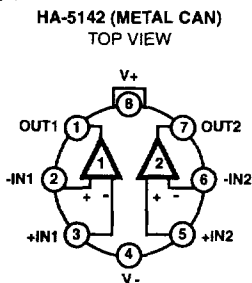
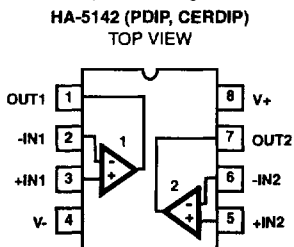

HA-5142, HA-5144

Ordering Information

PART NUMBER	TEMP. RANGE (°C)	PACKAGE	PKG. NO.
HA2-5142-2	-55 to 125	8 Pin Metal Can	T8.C
HA2-5142-5	0 to 75	8 Pin Metal Can	T8.C
HA3-5142-5	0 to 75	8 Ld PDIP	E8.3
HA7-5142-2	-55 to 125	8 Ld Cerdip	F8.3A
HA7-5142-5	0 to 75	8 Ld Cerdip	F8.3A
HA9P5142-9	-40 to 85	16 Ld SOIC	M16.3
HA1-5144-2	-55 to 125	14 Ld Cerdip	F14.3
HA1-5144-5	0 to 75	14 Ld Cerdip	F14.3
HA3-5144-5	0 to 75	14 Ld PDIP	E14.3
HA9P5144-5	0 to 75	16 Ld SOIC	M16.3
HA9P5144-9	-40 to 85	16 Ld SOIC	M16.3

Schematic Diagram

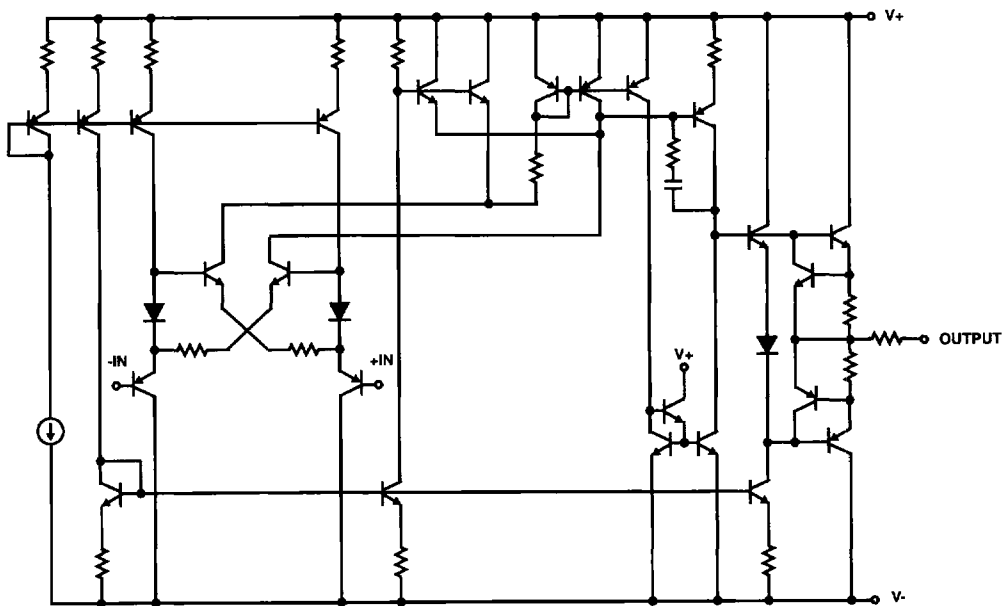

HA-5142, HA-5144

Absolute Maximum Ratings

Supply Voltage Between V+ and V- Terminals	35V
Differential Input Voltage	7V
Output Current	Short Circuit Protected

Operating Conditions

Temperature Range	
HA-5142/44-5	0°C to 75°C
HA-5142/44-2	-55°C to 125°C
HA-5142/44-9	-40°C to 85°C

Thermal Information

Thermal Resistance (Typical, Note 1)	θ_{JA} (°C/W)	θ_{JC} (°C/W)
14 Lead CERDIP Package	75	20
8 Pin Metal Can Package	155	67
14 Lead PDIP Package	100	N/A
8 Lead PDIP Package	120	N/A
8 Lead CERDIP Package	135	50
16 Lead SOIC Package (HA-5142)	110	N/A
16 Lead SOIC Package (HA-5144)	100	N/A
Maximum Junction Temperature (Hermetic Packages)	175°C	
Maximum Junction Temperature (Plastic Packages)	150°C	
Maximum Storage Temperature Range	-65°C to 150°C	
Maximum Lead Temperature (Soldering 10s)	300°C (SOIC - Lead Tips Only)	

CAUTION: Stresses above those listed in "Absolute Maximum Ratings" may cause permanent damage to the device. This is a stress only rating and operation of the device at these or any other conditions above those indicated in the operational sections of this specification is not implied.

NOTE:

- θ_{JA} is measured with the component mounted on an evaluation PC board in free air.

Electrical Specifications $R_S = 100\Omega$, $C_L \leq 10\text{pF}$, Unless Otherwise Specified

PARAMETER	TEST CONDITIONS	TEMP. (°C)	-2, -5, -9 V+ = +5V, V- = 0V			-2, -5, -9 V+ = +15V, V- = -15V			UNITS
			MIN	TYP	MAX	MIN	TYP	MAX	
			INPUT CHARACTERISTICS						
Offset Voltage	Note 11	25	-	2	6	-	2	6	mV
		Full	-	-	8	-	-	8	mV
Average Offset Voltage Drift		Full	-	3	-	-	3	-	$\mu\text{V}/^\circ\text{C}$
Bias Current	Note 11	25	-	45	100	-	45	100	nA
		Full	-	-	125	-	-	125	nA
Offset Current	Note 11	25	-	0.3	10	-	0.3	10	nA
		Full	-	-	20	-	-	20	nA
Common Mode Range		Full	0 to 3	-	-	± 10	-	-	V
Differential Input Resistance		25	-	0.6	-	-	0.6	-	M Ω
Input Noise Voltage	f = 1kHz	25	-	20	-	-	20	-	nV/ $\sqrt{\text{Hz}}$
Input Noise Current	f = 1kHz	25	-	0.25	-	-	0.25	-	pA/ $\sqrt{\text{Hz}}$
TRANSFER CHARACTERISTICS									
Large Signal Voltage Gain	Notes 2, 4	25	20	100	-	20	100	-	kV/V
		Full -2, -5	15	-	-	15	-	-	kV/V
		Full -9	12	-	-	12	-	-	kV/V
Common Mode Rejection Ratio	Note 7	Full -2, -5	77	105	-	77	105	-	cB
		Full -9	70	105	-	70	105	-	dB

HA-5142, HA-5144

Electrical Specifications $R_S = 100\Omega$, $C_L \leq 10\text{pF}$, Unless Otherwise Specified (Continued)

PARAMETER	TEST CONDITIONS	TEMP. (°C)	-2, -5, -9 $V_+ = +5\text{V}$, $V_- = 0\text{V}$			-2, -5, -9 $V_+ = +15\text{V}$, $V_- = -15\text{V}$			UNITS
			MIN	TYP	MAX	MIN	TYP	MAX	
Bandwidth	Notes 2, 3	25	-	0.4	-	-	0.4	-	MHz
OUTPUT CHARACTERISTICS									
Output Voltage Swing	Notes 2, 10	25	1.0 to 3.8	0.7 to 4.2	-	± 10	± 13	-	V
		Full	1.2 to 3.5	0.9 to 4.0	-	± 10	± 13	-	V
Full Power Bandwidth	Notes 2, 4, 8	25	-	240	-	-	24	-	kHz
TRANSIENT RESPONSE (Notes 2, 3)									
Rise Time		25	-	600	-	-	600	-	ns
Slew Rate	Note 6	25	0.8	1.5	-	0.8	1.5	-	V/ μs
Settling Time	Note 5	25	-	10	-	-	10	-	μs
POWER SUPPLY CHARACTERISTICS									
Supply Current		25	-	45	80	-	100	150	$\mu\text{A/Amp}$
		Full	-	-	100	-	-	200	$\mu\text{A/Amp}$
Power Supply Rejection Ratio	Note 9	Full	77	105	-	77	105	-	dB
		-2, -5	70	105	-	70	105	-	dB

NOTES:

2. $R_L = 50\text{k}\Omega$.
3. $C_L = 50\text{pF}$.
4. $V_O = 1.4$ to 2.5V for $V_{\text{SUPPLY}} = +5, 0\text{V}$; $V_O = \pm 10\text{V}$ for $V_{\text{SUPPLY}} = \pm 15\text{V}$.
5. Settling Time is specified to 0.1% of final value for a 3V output step and $A_V = -1$ for $V_{\text{SUPPLY}} = +5\text{V}, 0\text{V}$. Output step = 10V for $V_{\text{SUPPLY}} = \pm 15\text{V}$.
6. Maximum input slew rate = 10V/ μs .
7. $V_{\text{CM}} = 0$ to 3V for $V_{\text{SUPPLY}} = +5, 0\text{V}$; $V_{\text{CM}} = \pm 10\text{V}$ for $V_{\text{SUPPLY}} = \pm 15\text{V}$.
8. Full Power Bandwidth is guaranteed by equation: $\text{FPBW} = \frac{\text{Slew Rate}}{2\pi V_{\text{PEAK}}}$.
9. $\Delta V_S = +10\text{V}$ for $V_{\text{SUPPLY}} = +5, 0\text{V}$; $\Delta V_S = \pm 5\text{V}$ for $V_{\text{SUPPLY}} = \pm 15\text{V}$.
10. For $V_{\text{SUPPLY}} = +5, 0\text{V}$ terminate R_L at +2.5V. Typical output current is $\pm 3\text{mA}$.
11. $V_O = 1.4\text{V}$ for $V_{\text{SUPPLY}} = +5\text{V}, 0\text{V}$.

3
OPERATIONAL
AMPLIFIERS

Test Circuits and Waveforms

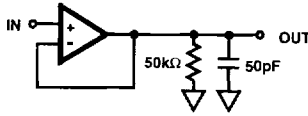
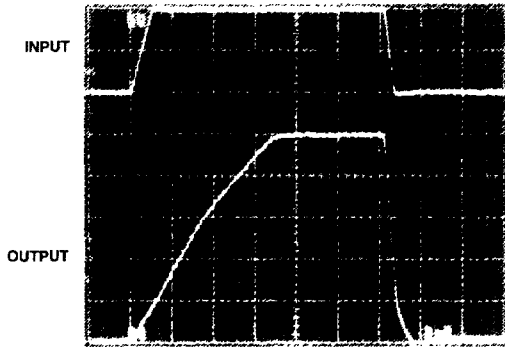

FIGURE 1. SLEW RATE AND TRANSIENT RESPONSE TEST CIRCUIT



+VSUPPLY = +15V, -VSUPPLY = -15V

Vertical Scale: Input = 5V/Div.; Output = 2V/Div.
Horizontal Scale: 2μs/Div.

LARGE SIGNAL RESPONSE

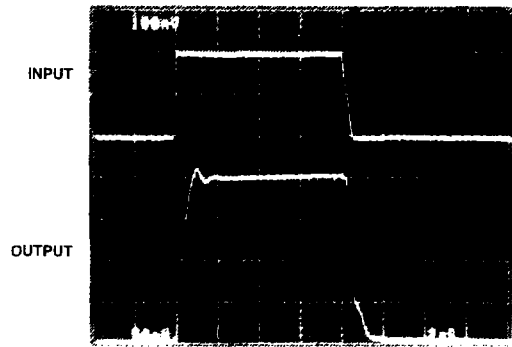

+VSUPPLY = +15V, -VSUPPLY = -15V

Vertical Scale: Input = 100mV/Div.; Output = 50mV/Div.
Horizontal Scale: 2μs/Div.

SMALL SIGNAL RESPONSE

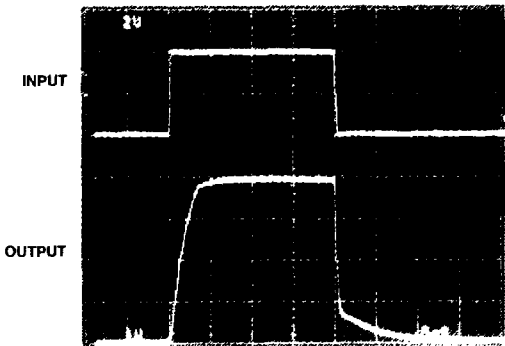

+VSUPPLY = +5V, -VSUPPLY = 0V

Vertical Scale: Input = 2V/Div.; Output = 1V/Div.
Horizontal Scale: 5μs/Div.

LARGE SIGNAL RESPONSE

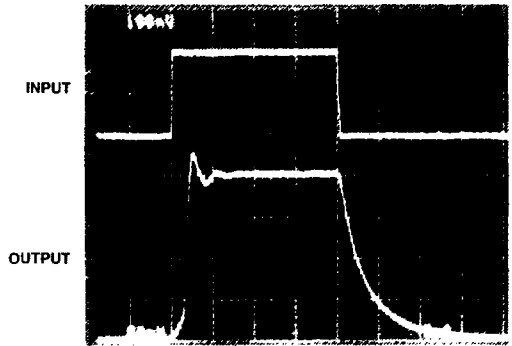

+VSUPPLY = +5V, -VSUPPLY = 0V

Vertical Scale: Input = 100mV/Div.; Output = 50mV/Div.
Horizontal Scale: 5μs/Div.

SMALL SIGNAL RESPONSE

Typical Performance Curves $V_S = \pm 2.5V$, $T_A = 25^\circ C$, Unless Otherwise Specified

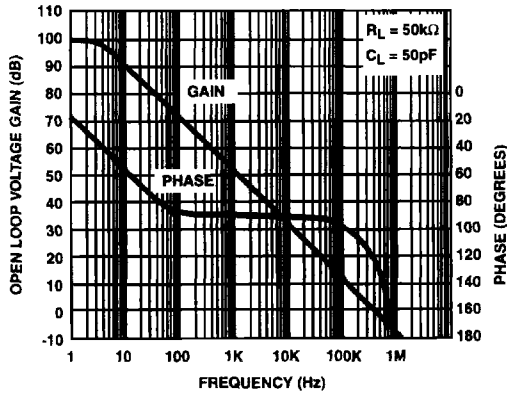

FIGURE 2. OPEN LOOP FREQUENCY RESPONSE

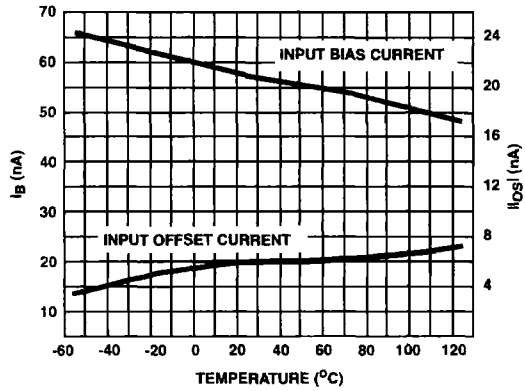

FIGURE 3. INPUT OFFSET CURRENT AND BIAS CURRENT vs TEMPERATURE

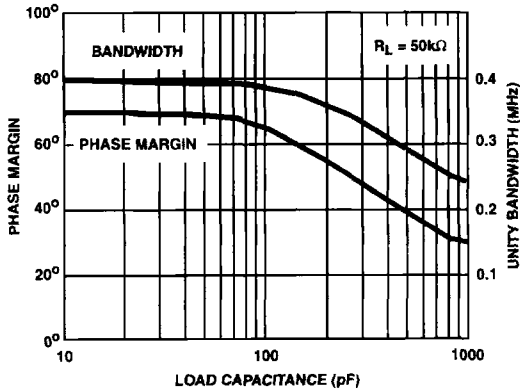

FIGURE 4. BANDWIDTH AND PHASE MARGIN vs LOAD CAPACITANCE

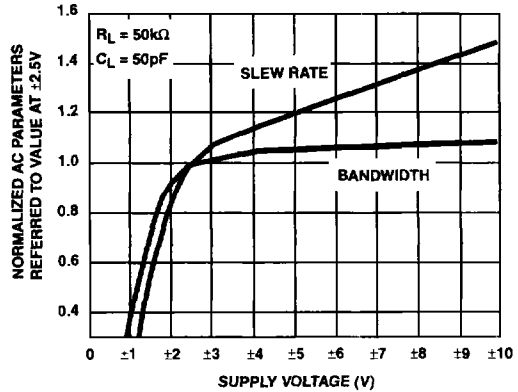

FIGURE 5. NORMALIZED AC PARAMETERS vs SUPPLY VOLTAGE

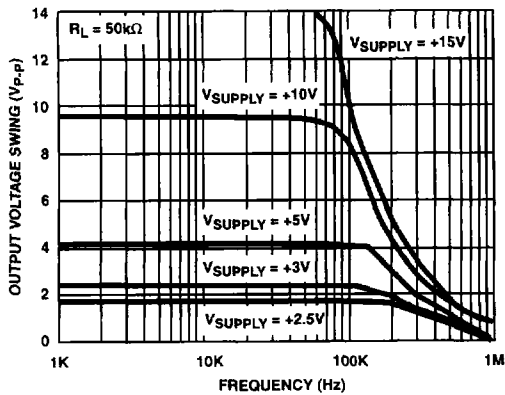

FIGURE 6. OUTPUT VOLTAGE SWING vs FREQUENCY AND SINGLE SUPPLY VOLTAGE

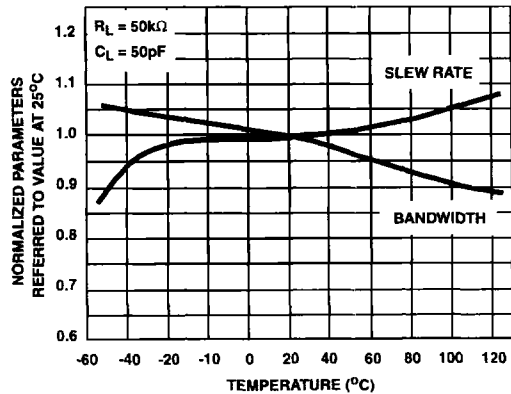

FIGURE 7. NORMALIZED AC PARAMETERS vs TEMPERATURE

Typical Performance Curves $V_S = \pm 2.5V, T_A = 25^\circ C$, Unless Otherwise Specified (Continued)

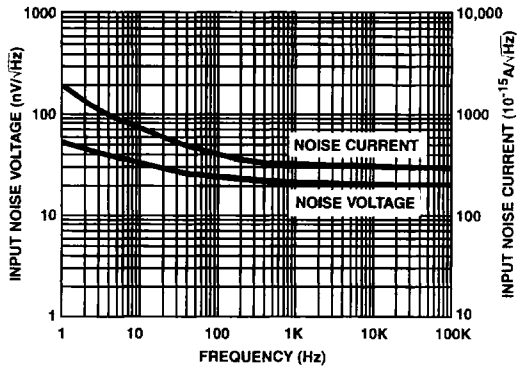

FIGURE 8. INPUT NOISE vs FREQUENCY

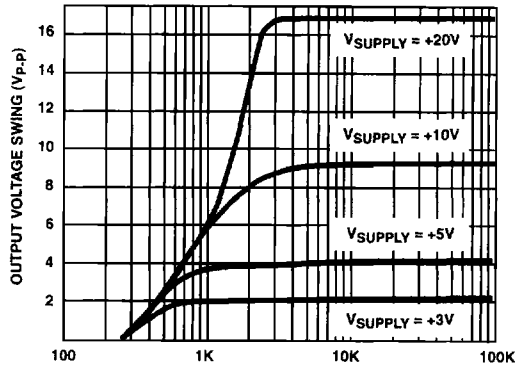

FIGURE 9. MAXIMUM OUTPUT VOLTAGE SWING vs LOAD RESISTANCE AND SINGLE SUPPLY VOLTAGE

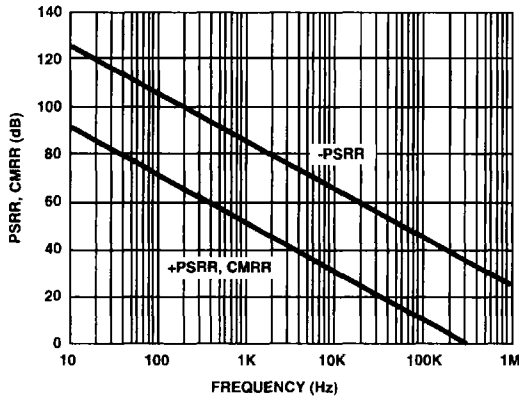

FIGURE 10. PSRR AND CMRR vs FREQUENCY

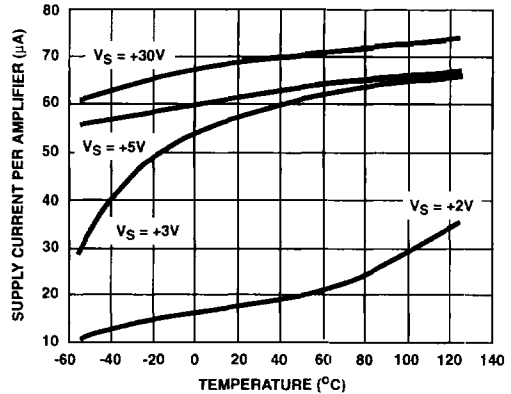

FIGURE 11. POWER SUPPLY CURRENT vs TEMPERATURE AND SINGLE SUPPLY VOLTAGE

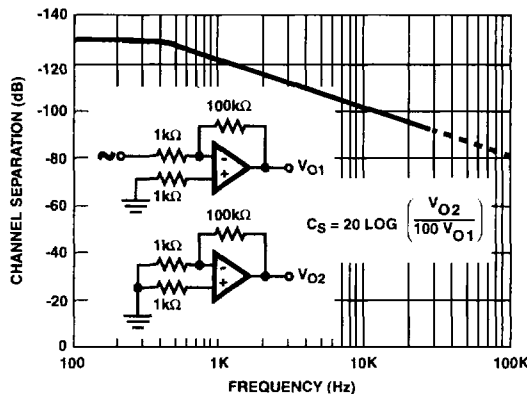

FIGURE 12. CHANNEL SEPARATION vs FREQUENCY

HA-5142, HA-5144

Die Characteristics

DIE DIMENSIONS:

104 mils x 55 mils x 19 mils
2650 μ m x 1400 μ m x 483 μ m

METALLIZATION:

Type: Al, 1% Cu
Thickness: 16k \AA \pm 2k \AA

PASSIVATION:

Type: Nitride (Si₃N₄) over Silox (SiO₂, 5% Phos.)
Silox Thickness: 12k \AA \pm 2k \AA
Nitride Thickness: 3.5k \AA \pm 1.5k \AA

TRANSISTOR COUNT:

72

SUBSTRATE POTENTIAL (Powered Up):

V-

PROCESS:

Bipolar/JFET Dielectric Isolation

Metallization Mask Layout

HA-5142

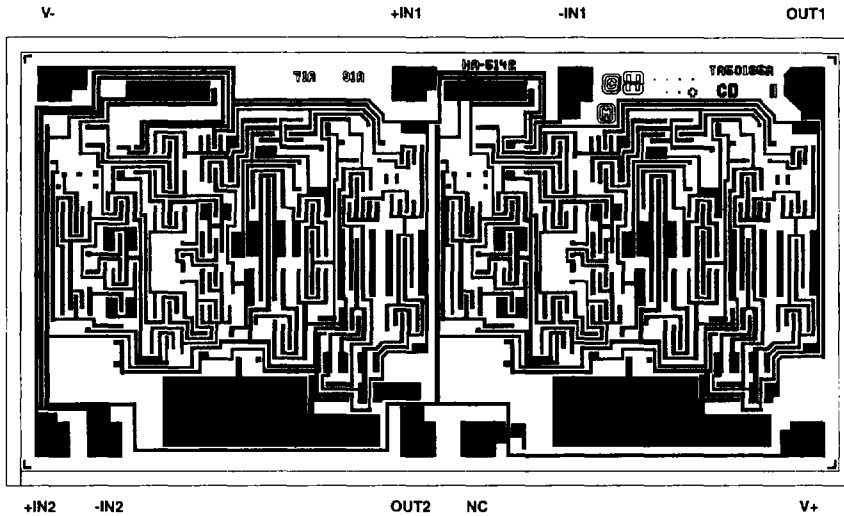

3

OPERATIONAL
AMPLIFIERS