

Rochester Electronics Manufactured Components

Rochester branded components are manufactured using either die/wafers purchased from the original suppliers or Rochester wafers recreated from the original IP. All recreations are done with the approval of the OCM.

Parts are tested using original factory test programs or Rochester developed test solutions to guarantee product meets or exceed the OCM data sheet.

Quality Overview

- ISO-9001
- AS9120 certification
- Qualified Manufacturers List (QML) MIL-PRF-35835
 - Class Q Military
 - Class V Space Level
- Qualified Suppliers List of Distributors (QSLD)
 - Rochester is a critical supplier to DLA and meets all industry and DLA standards.

Rochester Electronics, LLC is committed to supplying products that satisfy customer expectations for quality and are equal to those originally supplied by industry manufacturers.

The original manufacturer's datasheet accompanying this document reflects the performance and specifications of the Rochester manufactured version of this device. Rochester Electronics guarantees the performance of its semiconductor products to the original OEM specifications. 'Typical' values are for reference purposes only. Certain minimum or maximum ratings may be based on product characterization, design, simulation, or sample testing.

63MHz, Ultra-Low Noise Precision Operational Amplifier

November 1996

Features

- Slew Rate 20V/ μ s
- Wide Gain Bandwidth ($A_V \geq 5$) 63MHz
- Low Noise $3nV/\sqrt{Hz}$ at 1kHz
- Low V_{OS} 10 μ V
- High CMRR 126dB
- High Gain 1800V/mV

Applications

- High Speed Signal Conditioners
- Wide Bandwidth Instrumentation Amplifiers
- Low Level Transducer Amplifiers
- Fast, Low Level Voltage Comparators
- Highest Quality Audio Preamplifiers
- Pulse/RF Amplifiers
- For Further Design Ideas See Application Note 553

Ordering Information

PART NUMBER (BRAND)	TEMP. RANGE (°C)	PACKAGE	PKG. NO.
HA3-5137A-5	0 to 75	8 Ld PDIP	E8.3
HA7-5137-2	-55 to 125	8 Ld CERDIP	F8.3A
HA7-5137-5	0 to 75	8 Ld CERDIP	F8.3A
HA7-5137A-2	-55 to 125	8 Ld CERDIP	F8.3A
HA7-5137A-5	0 to 75	8 Ld CERDIP	F8.3A
HA9P5137-5 (H51375)	0 to 75	8 Ld SOIC	M8.15

Description

The HA-5137 operational amplifier features an unparalleled combination of precision DC and wideband high speed characteristics. Utilizing the Harris Dielectric Isolation technology and advanced processing techniques, this unique design unites low noise ($3nV/\sqrt{Hz}$) precision instrumentation performance with high speed (20V/ μ s) wideband capability.

This amplifier's impressive list of features include low V_{OS} (10 μ V), wide gain bandwidth (63MHz), high open loop gain (1800V/mV), and high CMRR (126dB). Additionally, this flexible device operates over a wide supply range ($\pm 5V$ to $\pm 20V$) while consuming only 140mW of power.

Using the HA-5137 allows designers to minimize errors while maximizing speed and bandwidth in applications requiring gains greater than five.

This device is ideally suited for low level transducer signal amplifier circuits. Other applications which can utilize the HA-5137's qualities include instrumentation amplifiers, pulse or RF amplifiers, audio preamplifiers, and signal conditioning circuits.

This device can easily be used as a design enhancement by directly replacing the 725, OP25, OP06, OP07, OP27 and OP37 where gains are greater than five. For the military grade product, refer to the HA-5137/883 data sheet.

Pinout

HA-5137, HA-5137A
 (PDIP, CERDIP, SOIC)
 TOP VIEW

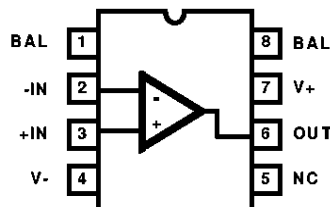

HA-5137, HA-5137A

Absolute Maximum Ratings

Voltage Between V+ and V- Terminals 44V
 Differential Input Voltage (Note 1)..... 0.7V
 Output Current Full Short Circuit Protection

Operating Conditions

Temperature Range
 HA-5137/37A-2 -55°C to 125°C
 HA-5137/37A-5 0°C to 75°C

Thermal Information

Thermal Resistance (Typical, Note 2) θ_{JA} (°C/W) θ_{JC} (°C/W)
 CERDIP Package 135 50
 PDIP Package 120 N/A
 SOIC Package 160 N/A
 Maximum Junction Temperature (Hermetic Package) 175°C
 Maximum Junction Temperature (Plastic Packages) 150°C
 Maximum Storage Temperature Range -65°C to 150°C
 Maximum Lead Temperature (Soldering 10s) 300°C
 (SOIC - Lead Tips Only)

Die Characteristics

Back Side Potential V-
 Number of Transistors 63

CAUTION: Stresses above those listed in "Absolute Maximum Ratings" may cause permanent damage to the device. This is a stress only rating and operation of the device at these or any other conditions above those indicated in the operational sections of this specification is not implied.

NOTES:

1. For differential input voltages greater than 0.7V, the input current must be limited to 25mA to protect the back-to-back input diodes.
2. θ_{JA} is measured with the component mounted on an evaluation PC board in free air.

Electrical Specifications $V_{SUPPLY} = \pm 15V$, $C_L \leq 50pF$, $R_S \leq 100\Omega$

PARAMETER	TEST CONDITIONS	TEMP. (°C)	HA-5137			HA-5137A			UNITS
			MIN	TYP	MAX	MIN	TYP	MAX	
INPUT CHARACTERISTICS									
Offset Voltage		25	-	30	100	-	10	25	μV
		Full	-	70	300	-	30	60	μV
Average Offset Voltage Drift		Full	-	0.4	1.8	-	0.2	0.6	$\mu V/^\circ C$
Bias Current		25	-	15	80	-	10	40	nA
		Full	-	35	150	-	20	60	nA
Offset Current		25	-	12	75	-	7	35	nA
		Full	-	30	135	-	15	50	nA
Common Mode Range		Full	± 10.3	± 11.5	-	± 10.3	± 11.5	-	V
Differential Input Resistance (Note 3)		25	0.8	4	-	1.5	6	-	M Ω
Input Noise Voltage (Note 4)	0.1Hz to 10Hz	25	-	0.09	0.25	-	0.08	0.18	μV_{P-P}
Input Noise Voltage Density (Note 5)	f = 10Hz	25	-	3.8	8.0	-	3.5	8.0	nV/ \sqrt{Hz}
	f = 100Hz	25	-	3.3	4.5	-	3.1	4.5	nV/ \sqrt{Hz}
	f = 1000Hz	25	-	3.2	3.8	-	3.0	3.8	nV/ \sqrt{Hz}
Input Noise Current Density (Note 5)	f = 10Hz	25	-	1.7	-	-	1.7	4.0	pA/ \sqrt{Hz}
	f = 100Hz	25	-	1.0	-	-	1.0	2.3	pA/ \sqrt{Hz}
	f = 1000Hz	25	-	0.4	0.6	-	0.4	0.6	pA/ \sqrt{Hz}
TRANSFER CHARACTERISTICS									
Large Signal Voltage Gain	$R_L = 2k\Omega$, $V_{OUT} = \pm 10V$	25	700	1500	-	1000	1800	-	V/mV
		Full	300	800	-	600	1200	-	V/mV
Common Mode Rejection Ratio	$V_{CM} = \pm 10V$	Full	100	120	-	114	126	-	dB
Minimum Stable Gain		25	5	-	-	5	-	-	V/V

HA-5137, HA-5137A

Electrical Specifications $V_{SUPPLY} = \pm 15V$, $C_L \leq 50pF$, $R_S \leq 100\Omega$ (Continued)

PARAMETER	TEST CONDITIONS	TEMP. (°C)	HA-5137			HA-5137A			UNITS
			MIN	TYP	MAX	MIN	TYP	MAX	
Gain-Bandwidth-Product	$f = 10kHz$	25	60	80	-	60	80	-	MHz
	$f = 1MHz$	25	-	63	-	-	63	-	MHz
OUTPUT CHARACTERISTICS									
Output Voltage Swing	$R_L = 600\Omega$	25	± 10.0	± 11.5	-	± 10.0	± 11.5	-	V
	$R_L = 2k\Omega$	Full	± 11.4	± 13.5	-	± 11.7	± 13.8	-	V
Full Power Bandwidth (Note 6)		25	220	320	-	220	320	-	kHz
Output Resistance	Open Loop	25	-	70	-	-	70	-	Ω
Output Current		25	16.5	25	-	16.5	25	-	mA
TRANSIENT RESPONSE (Note 7)									
Rise Time		25	-	-	100	-	-	100	ns
Slew Rate	$V_{OUT} = \pm 3V$	25	14	20	-	14	20	-	$V/\mu s$
Settling Time	Note 8	25	-	1.0	-	-	1.0	-	μs
Overshoot		25	-	20	40	-	20	40	%
POWER SUPPLY CHARACTERISTICS									
Supply Current		25	-	3.5	-	-	3.5	-	mA
		Full	-	-	4.0	-	-	4.0	mA
Power Supply Rejection Ratio	$V_S = \pm 4V$ to $\pm 18V$	Full	-	16	51	-	2	4	$\mu V/V$

NOTES:

3. This parameter value is based upon design calculations.
4. Refer to Typical Performance section of the data sheet.
5. The limits for this parameter are based on lab characterization, and reflect lot-to-lot variation.
6. Full power bandwidth guaranteed based on slew rate measurement using: $FPBW = \frac{\text{Slew Rate}}{2\pi V_{PEAK}}$.
7. Refer to Test Circuits section of the data sheet.
8. Settling time is specified to 0.1% of final value for a 10V output step and $A_V = -5$.

Test Circuits and Waveforms

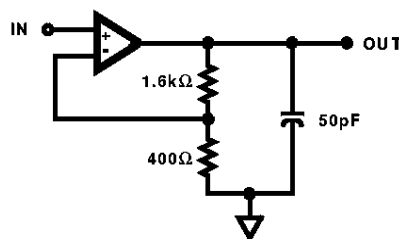
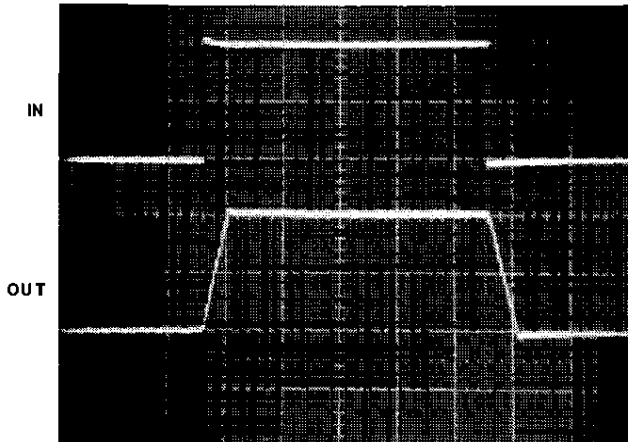

FIGURE 1. LARGE AND SMALL SIGNAL RESPONSE TEST CIRCUIT

Test Circuits and Waveforms (Continued)



Vertical Scale: Input = 1V/Div.
 Output = 5V/Div.
 Horizontal Scale: 1 μ s/Div.

LARGE SIGNAL RESPONSE

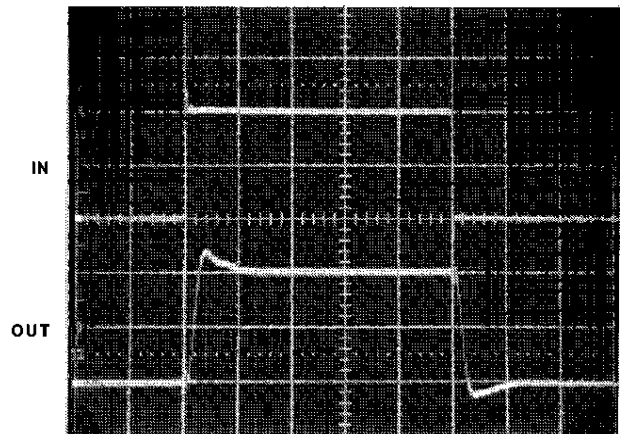

Vertical Scale: Input = 20mV/Div.
 Output = 100mV/Div.
 Horizontal Scale: 100ns/Div.

SMALL SIGNAL RESPONSE

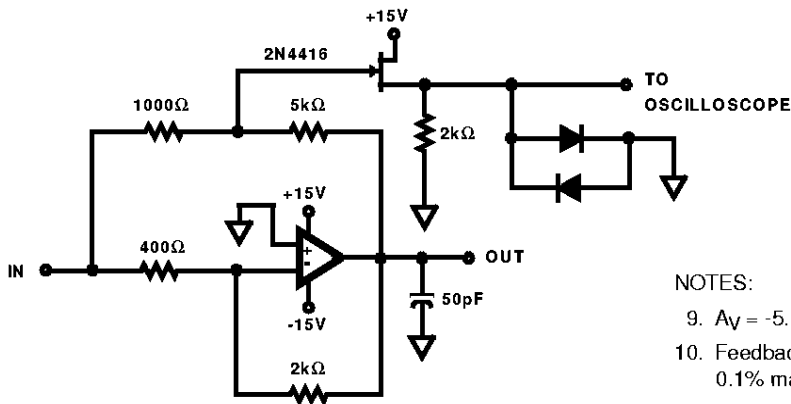

NOTES:

9. $A_V = -5$.
10. Feedback and summing resistors should be 0.1% matched.
11. Clipping diodes are optional. HP5082-2810 recommended.

FIGURE 2. SETTLING TIME TEST CIRCUIT

Schematic Diagram

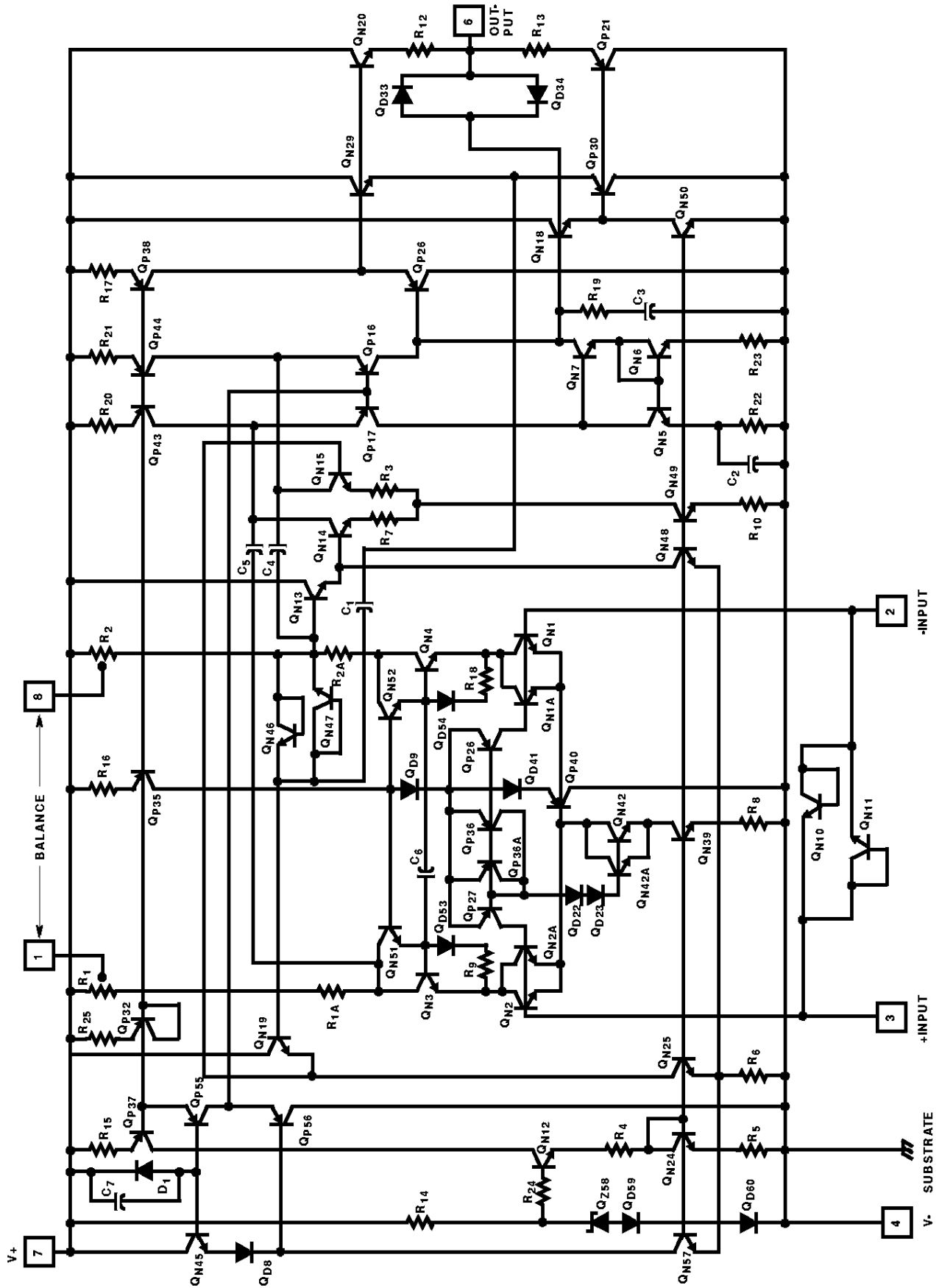

Application Information

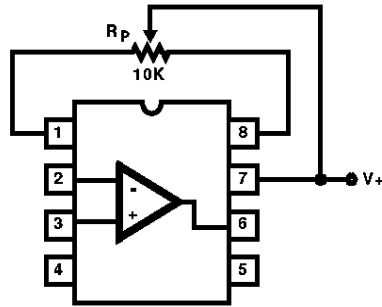

NOTE: Tested Offset Adjustment Range is $|V_{OS} + 1mV|$ minimum referred to output. Typical range is $\pm 4mV$ with $R_P = 10k\Omega$.

FIGURE 3. SUGGESTED OFFSET VOLTAGE ADJUSTMENT

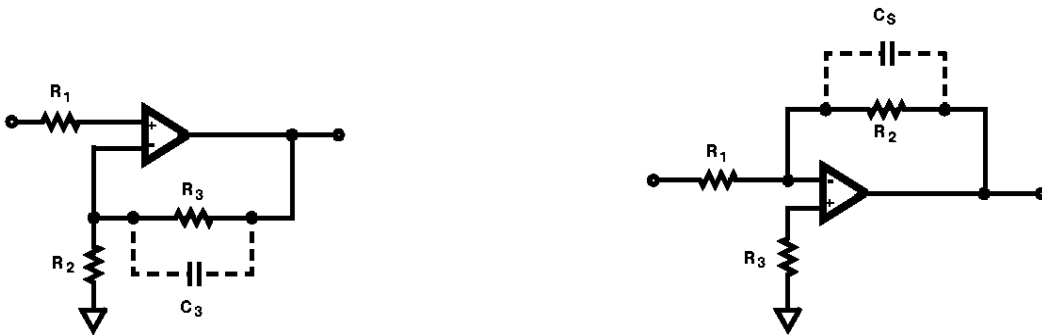

NOTE: Low resistances are preferred for low noise applications as a $1k\Omega$ resistor has $4nV/\sqrt{Hz}$ of thermal noise. Total resistances of greater than $10k\Omega$ on either input can reduce stability. In most high resistance applications, a few picofarads of capacitance across the feedback resistor will improve stability.

FIGURE 4. SUGGESTED STABILITY CIRCUITS

Typical Performance Curves Unless Otherwise Specified: $T_A = 25^\circ C$, $V_{SUPPLY} = \pm 15V$

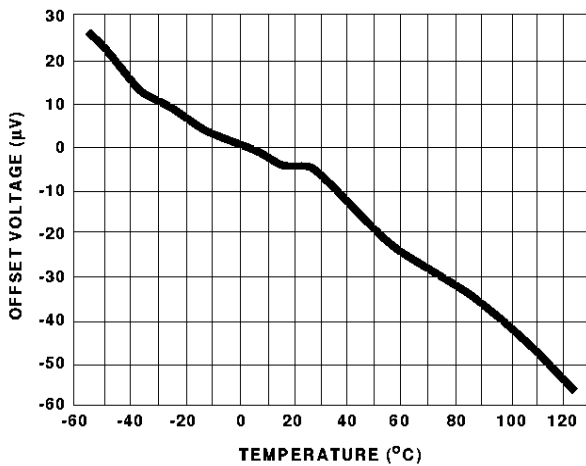

FIGURE 5. TYPICAL OFFSET VOLTAGE DRIFT vs TEMPERATURE

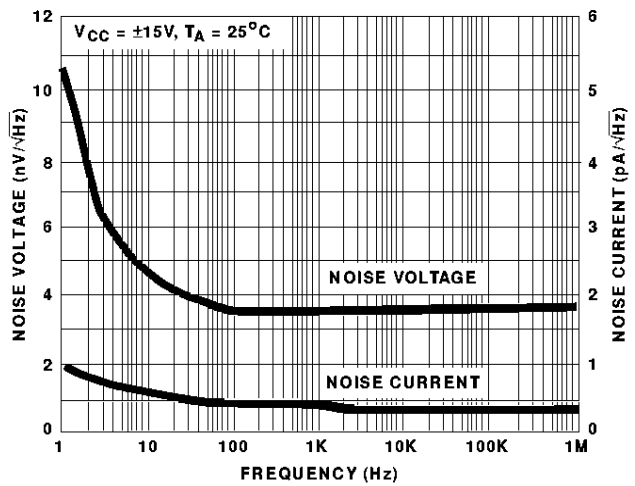

FIGURE 6. NOISE CHARACTERISTICS

Typical Performance Curves Unless Otherwise Specified: $T_A = 25^\circ\text{C}$, $V_{\text{SUPPLY}} = \pm 15\text{V}$ (Continued)

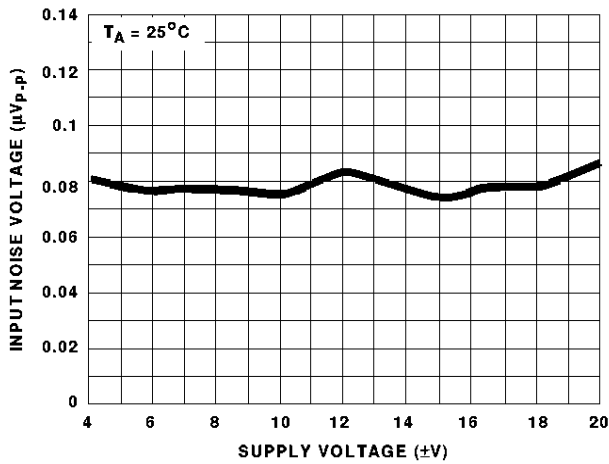

FIGURE 7. NOISE vs SUPPLY VOLTAGE

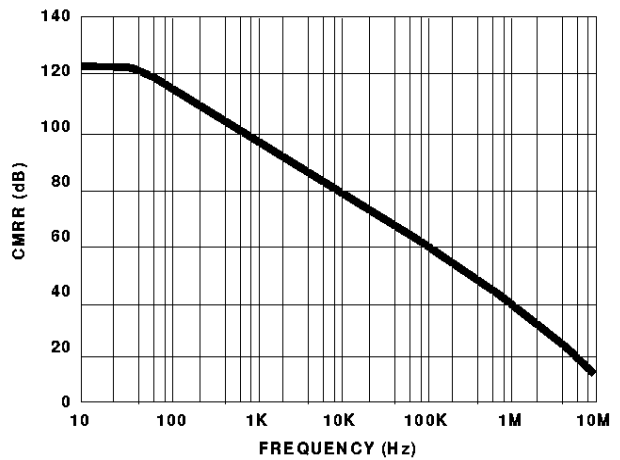

FIGURE 8. CMRR vs FREQUENCY

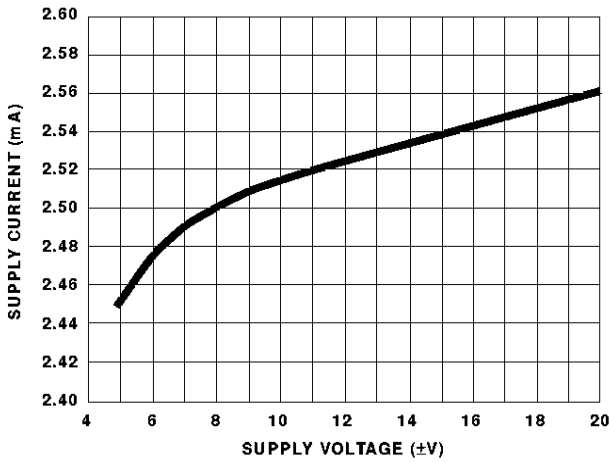

FIGURE 9. SUPPLY CURRENT vs SUPPLY VOLTAGE

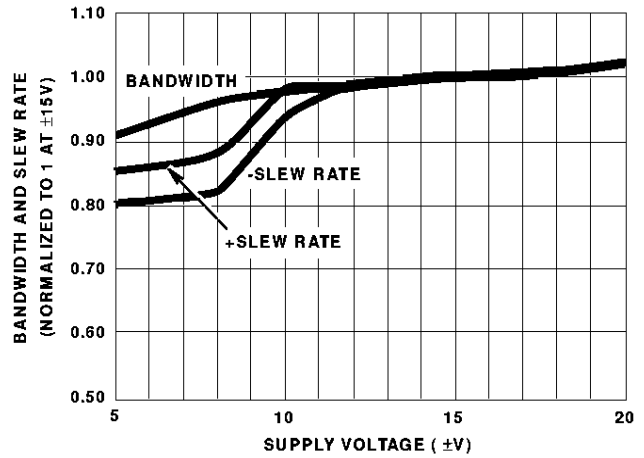

FIGURE 10. BANDWIDTH AND SLEW RATE vs SUPPLY VOLTAGE

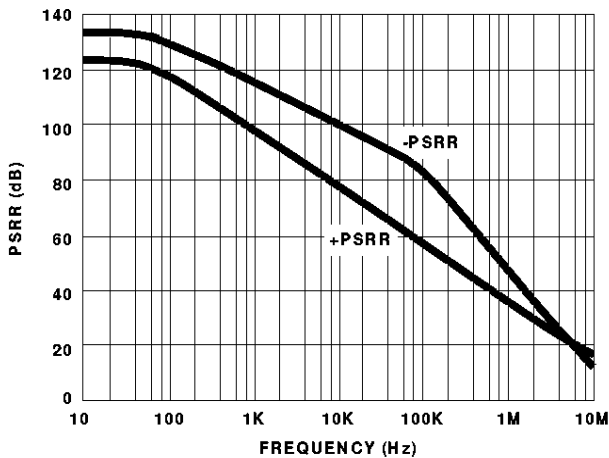

FIGURE 11. PSRR vs FREQUENCY

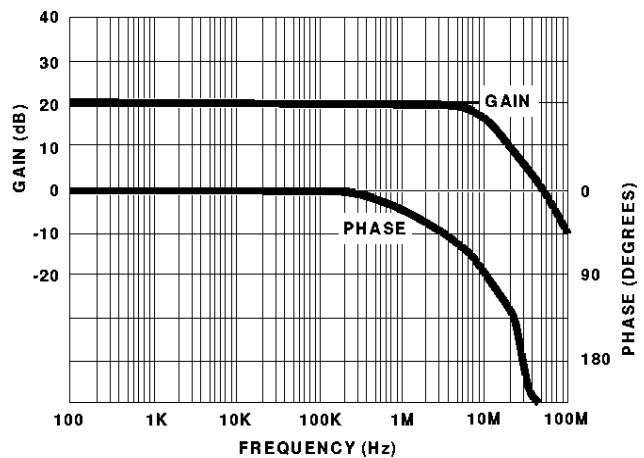

FIGURE 12. CLOSED LOOP GAIN AND PHASE vs FREQUENCY

Typical Performance Curves Unless Otherwise Specified: $T_A = 25^\circ\text{C}$, $V_{\text{SUPPLY}} = \pm 15\text{V}$ (Continued)

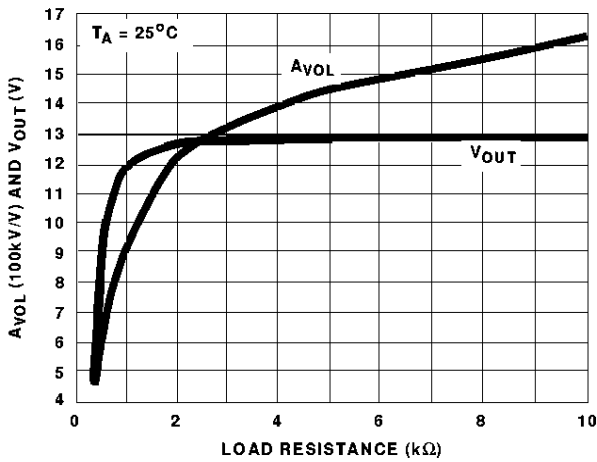

FIGURE 13. A_{VOL} AND V_{OUT} vs LOAD RESISTANCE

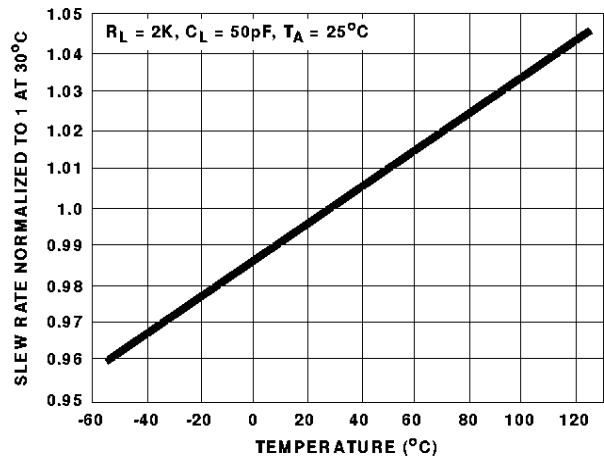

FIGURE 14. NORMALIZED SLEW RATE vs TEMPERATURE

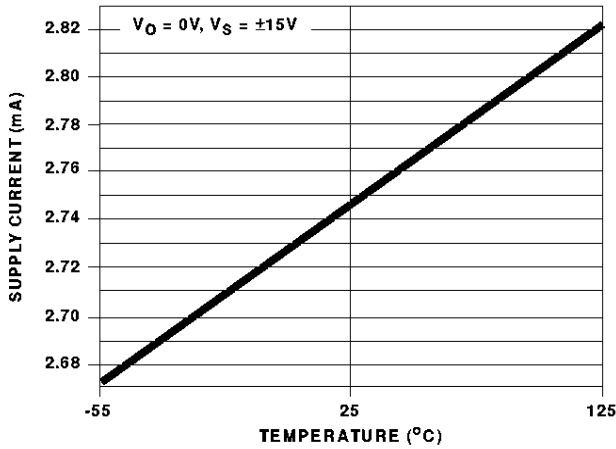

FIGURE 15. SUPPLY CURRENT vs TEMPERATURE

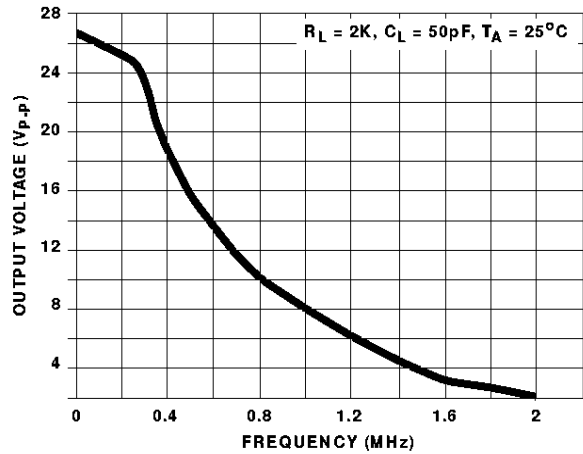

FIGURE 16. $V_{\text{OUT MAX}}$ (UNDISTORTED SINEWAVE OUTPUT) vs FREQUENCY

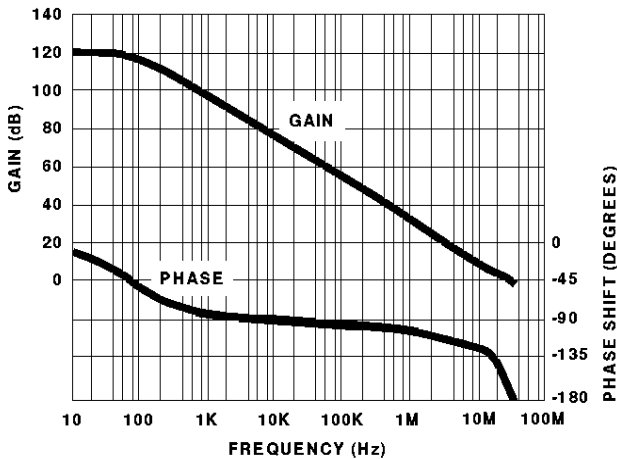
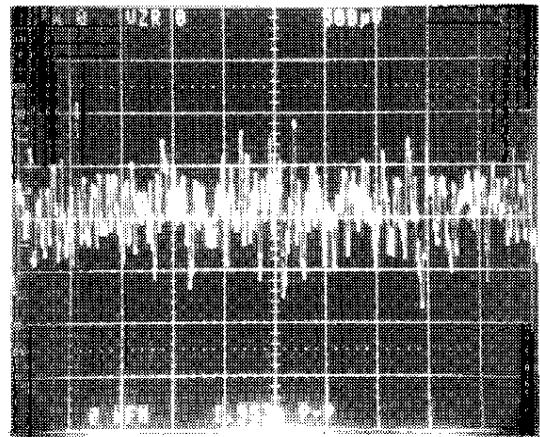

FIGURE 17. OPEN LOOP GAIN AND PHASE vs FREQUENCY



$A_{\text{CL}} = 25,000\text{V/V}$
Horizontal Scale = 1s/Div.
Vertical Scale = $0.002\mu\text{V/Div.}$, $E_N = 0.08\mu\text{V}_{\text{P-P RTI}}$

FIGURE 18. PEAK-TO-PEAK NOISE VOLTAGE (0.1Hz TO 10Hz)