

Features

- High Slew Rate 120V/ μ s
- Fast Settling 200ns
- Wide Power Bandwidth 2,000kHz
- High Gain Bandwidth ($A_V \geq 3$) 20MHz
- High Input Impedance 100M Ω
- Low Offset Current 10nA

Applications

- Data Acquisition Systems
- R.F. Amplifiers
- Video Amplifiers
- Signal Generators
- Pulse Amplification

Description

HA-2520/2522/2525 comprise a series of monolithic operational amplifiers delivering an unsurpassed combination of specifications for slew rate, bandwidth and settling time. These dielectrically isolated amplifiers are controlled at close loop gains greater than 3 without external compensation. In addition, these high performance components also provide low offset current and high input impedance.

120V/ μ s slew rate and 200ns (0.2%) settling time of these amplifiers make them ideal components for pulse amplification and data acquisition designs. These devices are valuable components for R.F. and video circuitry requiring up to 20MHz gain bandwidth and 2MHz power

bandwidth. For accurate signal conditioning designs the HA-2520/2522/2525's superior dynamic specifications are complimented by 10nA offset current, 200M Ω input impedance and offset trim capability.

The HA-2520 and HA-2522 have guaranteed operation from -55 $^{\circ}$ C to +125 $^{\circ}$ C and are available in metal can and ceramic miniDIP packages. Both are offered in /883 grade with the HA-2522 also available in LCC package. The HA-2525 has guaranteed operation from 0 $^{\circ}$ C to +75 $^{\circ}$ C and is available in plastic and ceramic miniDIP and metal can packages. Mil-Std-883 product and data sheets are available upon request.

Pinouts

HA7-2520/22/25 (CERAMIC MINI-DIP)
HA3-2525 (PLASTIC MINI-DIP)
TOP VIEW

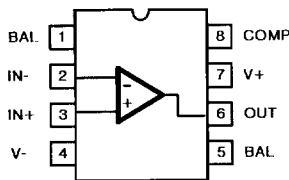

HA2-2520/22/25 (TO-99 METAL CAN)
TOP VIEW

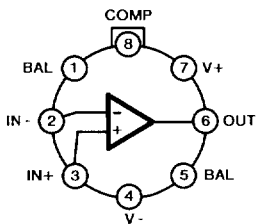

Schematic

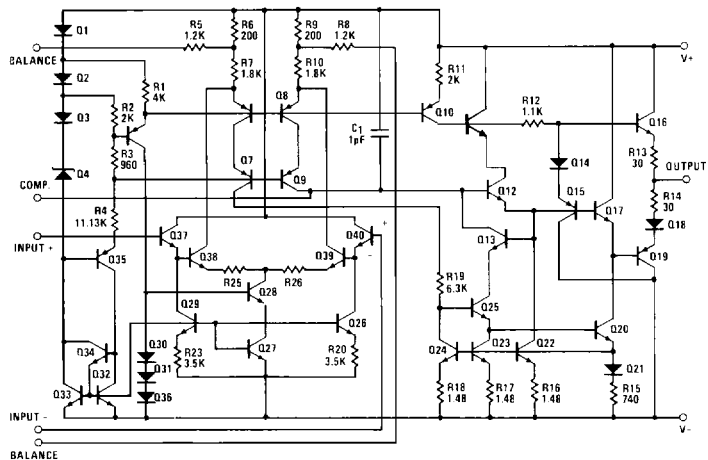

Specifications HA-2520/2522/2525

Absolute Maximum Ratings (Note 13)

Voltage Between V+ and V- Terminals..... 40.0V	Operating Temperature Range
Differential Input Voltage..... $\pm 15.0V$	HA-2520/2522 $-55^{\circ}C \leq T_A \leq +125^{\circ}C$
Peak Output Current..... 50mA	HA-2525..... $0^{\circ}C \leq T_A \leq +75^{\circ}C$
Internal Power Dissipation..... 300mW	Storage Temperature Range $-65^{\circ}C \leq T_A \leq +150^{\circ}C$
Lead Solder Temperature (10 Seconds)..... $+275^{\circ}C$	Maximum Junction Temperature..... $+175^{\circ}C$

Electrical Specifications $V+ = +15V$ D.C., $V- = -15V$ D.C.

PARAMETER	TEMP	HA-2520 -55°C to +125°C			HA-2522 -55°C to +125°C			HA-2525 0°C to +75°C			UNITS
		MIN	TYP	MAX	MIN	TYP	MAX	MIN	TYP	MAX	
INPUT CHARACTERISTICS											
Offset Voltage	+25°C		4	8		5	10		5	10	mV
	Full			11			14			14	mV
Offset Voltage Average Drift	Full		20			25			30		$\mu V/^{\circ}C$
Bias Current	+25°C		100	200		125	250		125	250	nA
	Full			400			500			500	nA
Offset Current	+25°C		10	25		20	50		20	50	nA
	Full			50			100			100	nA
Input Resistance (Note 9)	+25°C	50	100		40	100		40	100		$M\Omega$
Common Mode Range	Full	± 10.0			± 10.0			± 10.0			V
TRANSFER CHARACTERISTICS											
Large Signal Voltage Gain (Note 1, 4)	+25°C	10K	15K		7.5K	15K		7.5K	15K		V/V
	Full	7.5K			5K			5K			V/V
Common Mode Rejection Ratio (Note 2)	Full	80	90		74	90		74	90		dB
Gain Bandwidth Product (Notes 3, 12)	+25°C	10	20		10	20		10	20		MHz
OUTPUT CHARACTERISTICS											
Output Voltage Swing (Note 1)	Full	± 10.0	± 12.0		± 10.0	± 12.0		± 10.0	± 12.0		V
Output Current (Note 4)	+25°C	± 10	± 20		± 10	± 20		± 10	± 20		mA
Full Power Bandwidth (Notes 4, 10)	+25°C	1500	2000		1200	1600		1200	1600		kHz
TRANSIENT RESPONSE ($A_V = +3$)											
Rise Time (Notes 1, 5, 6 & 8)	+25°C		25	50		25	50		25	50	ns
Overshoot (Notes 1, 5, 6 & 8)	+25°C		25	40		25	50		25	50	%
Slew Rate (Notes 1, 5, 8 & 11)	+25°C	± 100	± 120		± 80	± 120		± 80	± 120		$V/\mu s$
Settling Time (Notes 1, 5, 8 & 11)	+25°C		0.20			0.20			0.20		μs
POWER SUPPLY CHARACTERISTICS											
Supply Current	+25°C		4	6		4	6		4	6	mA
Power Supply Rejection Ratio (Note 7)	Full	80	90		74	90		74	90		dB

NOTES:

- | | | |
|-----------------------|--|--|
| 1. $R_L = 2k\Omega$ | 6. $V_O = \pm 200mV$ | 9. This parameter value is based on design calculations. |
| 2. $V_{CM} = \pm 10V$ | 7. $\Delta V = \pm 5.0V$ | 12. Guaranteed by design. |
| 3. $A_V > 10$ | 8. See Transient Response Test Circuits and Waveforms. | 13. Absolute Maximum Ratings are limiting values, applied individually, beyond which the serviceability of the circuit may be impaired. Functional operation under any of these conditions is not necessarily implied. |
| 4. $V_O = \pm 10.0V$ | 10. Full Power Bandwidth guaranteed based on slow rate measurement using $FPBW = S.R./2\pi V_{peak}$ | |
| 5. $C_L = 50pF$ | | |

HA-2520/2522/2525 Performance Curves

$V_S = \pm 15V$ D.C., $T_A = +25^\circ C$ Unless Otherwise Stated

INPUT BIAS AND OFFSET CURRENT vs TEMPERATURE

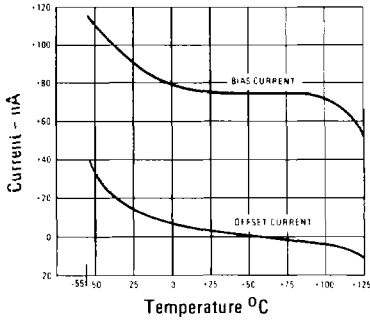

EQUIVALENT INPUT NOISE vs BANDWIDTH

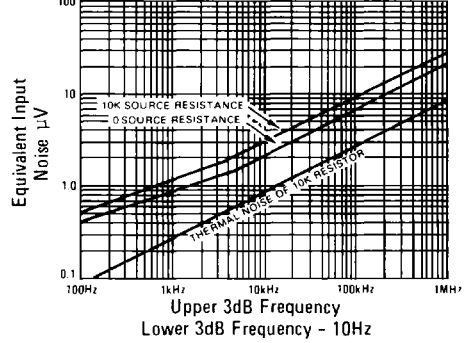

NORMALIZED AC PARAMETERS vs TEMPERATURE

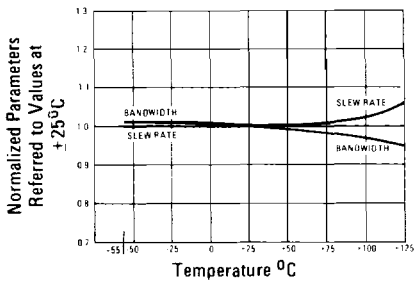

OPEN-LOOP FREQUENCY AND PHASE RESPONSE

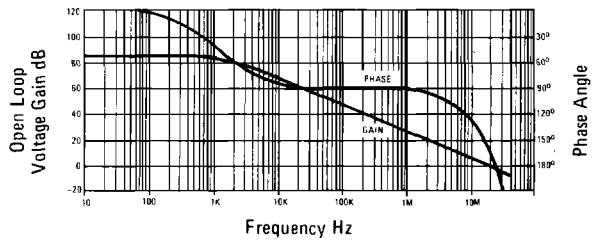

OPEN LOOP FREQUENCY RESPONSE FOR VARIOUS VALUES OF CAPACITORS FROM BANDWIDTH CONTROL PIN TO GROUND

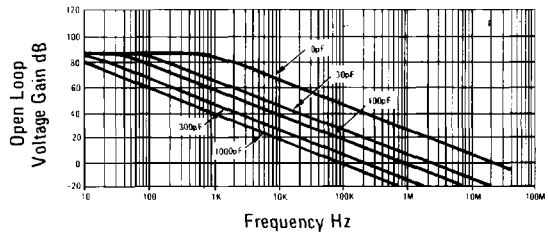

NORMALIZED AC PARAMETERS vs SUPPLY VOLTAGE AT +25 degrees Celsius

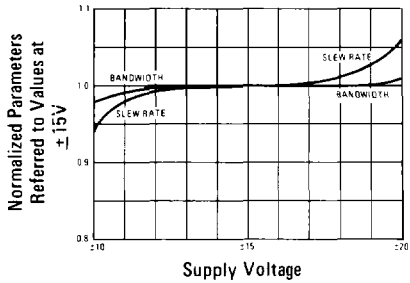

OUTPUT VOLTAGE SWING vs FREQUENCY AT +25 degrees Celsius

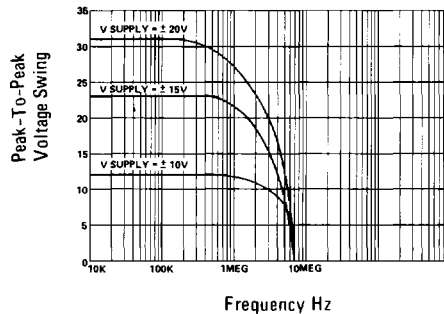

OPEN LOOP VOLTAGE GAIN vs TEMPERATURE

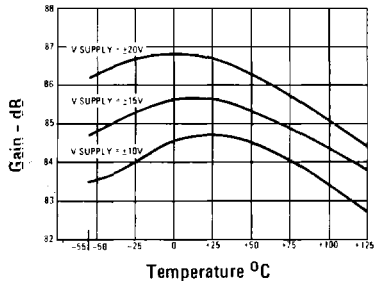

POWER SUPPLY CURRENT VS TEMPERATURE

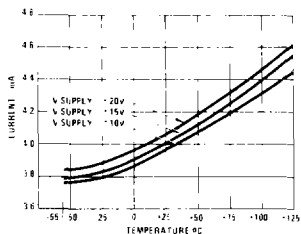

VOLTAGE FOLLOWER PULSE RESPONSE

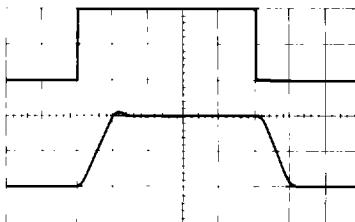

$R_L = 2K\Omega$, $C_L = 50pF$
Upper Trace Input, 1.67V Div
Lower Trace Output, 5V Div

Horizontal = 100ns/Div
 $T_A = +25^\circ C$, $V_S = \pm 15V$

POWER SUPPLY REJECTION RATIO VS FREQUENCY

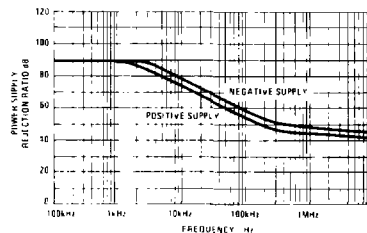

Test Circuits

SLEW RATE AND SETTLING TIME

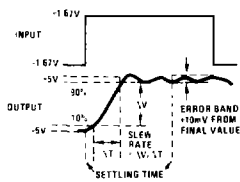

TRANSIENT RESPONSE

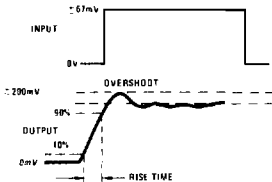

SLEW RATE AND TRANSIENT RESPONSE

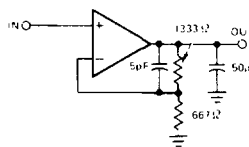

SUGGESTED VOS ADJUSTMENT

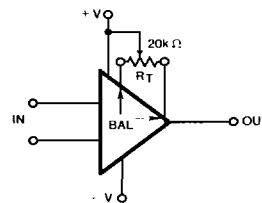

NOTE: Measurement on both positive and negative transitions from 0V to +200mV and 0V to -200mV at the output.

Tested Offset Adjustment Range is $|V_{OS} + 1mV|$ minimum referred to output. Typical range is +20mV to -18mV with $R_T = 20k\Omega$.

Settling Time Circuit

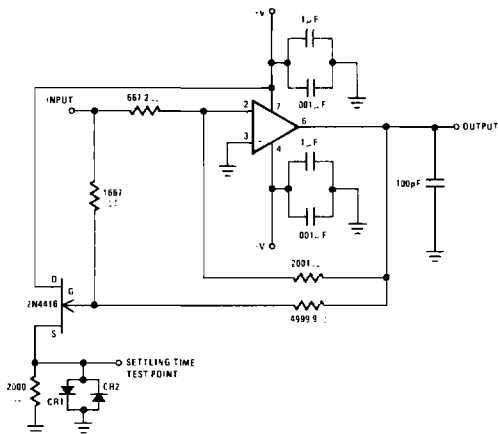

- $A_v = -3$
- Feedback and Summing Resistor Ratios should be 0.1% matched
- Clipping Diodes CR1 and CR2 are Optional HP5082-2810 Recommended

Typical Application

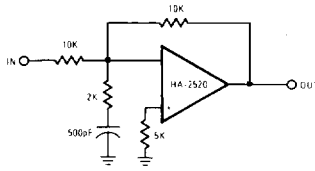

NOTE: Compensation Circuit for $A_V = -1$
 Slew Rate $\approx 120V/\mu s$
 Bandwidth $\approx 10MHz$
 Settling Time (0.1%) $\approx 500ns$

Capacitance at pin 8 must be minimized for maximum bandwidth.
 Tested and functional with supply voltages from $\pm 4V$ to $\pm 15V$.

FREQUENCY RESPONSE FOR INVERTING UNITY GAIN CIRCUIT

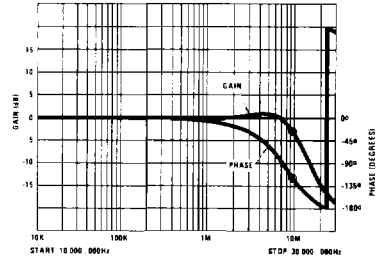

Die Characteristics

Transistor Count	40	
Die Dimensions	50 x 65 x 19 mils	
Substrate Potential	Unbiased	
Process	Bipolar-DI	
Thermal Constants ($^{\circ}C/W$)	θ_{ja}	θ_{jc}
HA2- Metal Can (-2, -5, -7)	206	56
HA2- Metal Can (-8, /883)	168	52
HA3- Plastic Mini-DIP (-5)	90	39
HA4- Ceramic LCC (/883)	99	37
HA7- Ceramic Mini-DIP (-8, /883)	140	65
HA7- Ceramic Mini-DIP (-2, -5, -7)	204	112