

Precision Low-voltage Amplifier; DC to 1 kHz

Features

- Low Offset: 10 μ V Max
- Low Drift: 0.05 μ V/°C Max
- Low Noise
 - 12 nV/ $\sqrt{\text{Hz}}$ @ 0.5 Hz
 - 0.1 to 10 Hz = 250 nVp-p
 - 1/f corner @ 0.08 Hz
- Open-loop Voltage Gain
 - 300 dB Typ
 - 200 dB Min
- Rail-to-rail Output Swing
- Slew Rate: 2 V/ μ s

Applications

- Thermocouple/Thermopile Amplifiers
- Load Cell and Bridge Transducer Amplifiers
- Precision Instrumentation
- Battery-powered Systems

Description

The CS3011 single amplifier and the CS3012 dual amplifier are designed for precision amplification of low-level signals and are ideally suited to applications that require very high closed-loop gains. These amplifiers achieve excellent offset stability, super-high open-loop gain, and low noise over time and temperature. The devices also exhibit excellent CMRR and PSRR. The common mode input range includes the negative supply rail. The amplifiers operate with any total supply voltage from 2.7 V to 6.7 V (± 1.35 V to ± 3.35 V).

Pin Configurations

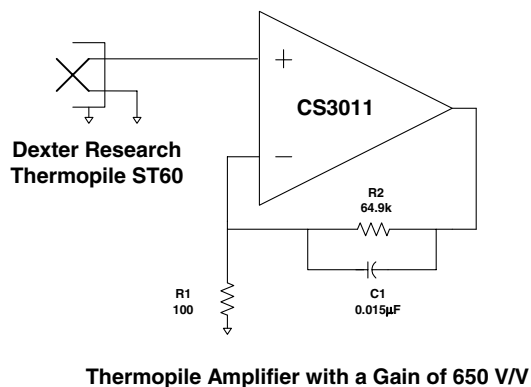
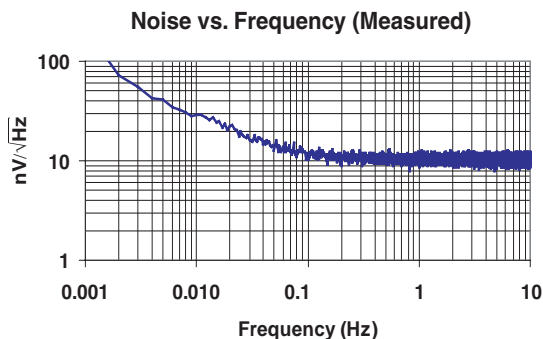
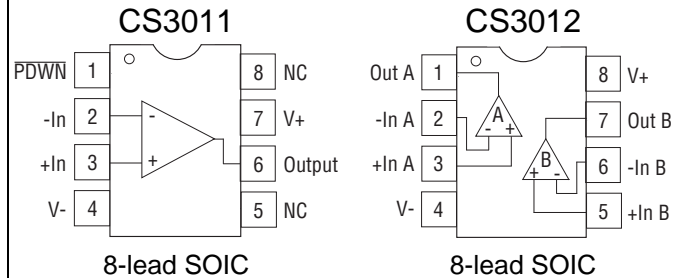

TABLE OF CONTENTS

1. CHARACTERISTICS AND SPECIFICATIONS	3
2. TYPICAL PERFORMANCE PLOTS	4
3. CS3011/CS3012 OVERVIEW	8
3.1 Open Loop Gain and Phase Response	9
3.2 Open Loop Gain and Stability Compensation	10
3.2.1 Discussion	10
3.2.2 Gain Calculations Summary and Recommendations	13
3.3 Powerdown (PDWN)	13
3.4 Applications	14
4. ORDERING INFORMATION	15
5. ENVIRONMENTAL, MANUFACTURING, & HANDLING INFORMATION	15
6. PACKAGE DRAWING	16
7. REVISION HISTORY	17

LIST OF FIGURES

Figure 1. Noise vs. Frequency (Measured)	4
Figure 2. 0.01 Hz to 10 Hz Noise	4
Figure 3. Supply Current vs. Temperature, 3011	4
Figure 4. Noise vs. Frequency	4
Figure 5. Offset Voltage Stability (DC to 3.2 Hz)	4
Figure 6. Supply Current vs. Temperature, 3012	4
Figure 7. Supply Current vs. Voltage, 3011	5
Figure 8. Supply Current vs. Voltage, 3012	5
Figure 9. Open Loop Gain and Phase vs Frequency	5
Figure 10. Open Loop Gain and Phase vs Frequency (Expanded)	6
Figure 11. Input Bias Current vs Common Mode Voltage (CS3012)	6
Figure 12. Voltage Swing vs. Output Current (2.7 V)	7
Figure 13. Voltage Swing vs. Output Current (5 V)	7
Figure 14. CS3011/CS3012 Open Loop Gain and Phase Response	9
Figure 15. Non-Inverting Gain Configuration	10
Figure 16. Non-Inverting Gain Configuration with Compensation	11
Figure 17. Loop Gain Plot: Unity Gain and with Pole-Zero Compensation	12
Figure 18. Thermopile Amplifier with a Gain of 650 V/V	14
Figure 19. Load Cell Bridge Amplifier and A/D Converter	14

1. CHARACTERISTICS AND SPECIFICATIONS

ELECTRICAL CHARACTERISTICS

V+ = +5 V, V- = 0V, VCM = 2.5 V (Note 1)

Parameter		CS3011/CS3012			Unit
		Min	Typ	Max	
Input Offset Voltage (Note 2)	•	-	-	±10	μV
Average Input Offset Drift (Note 2)	•	-	±0.01	±0.05	μV/°C
Long Term Input Offset Voltage Stability		(Note 3)			
Input Bias Current T _A = 25° C	•	-	±50	-	pA
	•	-	-	±1000	
Input Offset Current T _A = 25° C	•	-	±100	-	pA
	•	-	-	±2000	
Input Noise Voltage Density R _S = 100 Ω, f ₀ = 1 Hz		-	12		nV/√Hz
R _S = 100 Ω, f ₀ = 1 kHz		-	12		nV/√Hz
Input Noise Voltage 0.1 to 10 Hz		-	250		nV _{p-p}
Input Noise Current Density f ₀ = 1 Hz		-	100		fA/√Hz
Input Noise Current 0.1 to 10 Hz		-	1.9		pA _{p-p}
Input Common Mode Voltage Range	•	-0.1	-	(V+)-1.25	V
Common Mode Rejection Ratio (dc) (Note 4)	•	115	120	-	dB
Power Supply Rejection Ratio	•	120	136	-	dB
Large Signal Voltage Gain R _L = 2 kΩ to V+/2 (Note 5)	•	200	300	-	dB
Output Voltage Swing R _L = 2 kΩ to V+/2	•	+4.7	-	-	V
R _L = 100 kΩ to V+/2			+4.99		V
Slew Rate R _L = 2 k, 100 pF			2	-	V/μs
Overload Recovery Time		-	600	-	μs
Supply Current CS3011	•	-	0.9	1.4	mA
CS3012	•		1.7	2.4	mA
PWDN active (CS3011 Only) (Note 6)	•			15	μA
PWDN Threshold (Note 6)	•	(V+) -1.0			
Start-up Time (Note 7)	•	-	9	12	ms

- Notes:
1. Symbol “•” denotes specification applies over -40 to +85 ° C.
 2. This parameter is guaranteed by design and laboratory characterization. Thermocouple effects prohibit accurate measurement of these parameters in automatic test systems.
 3. 1000-hour life test data @ 125 °C indicates randomly distributed variation approximately equal to measurement repeatability of 1 μV.
 4. Measured within the specified common mode range limits.
 5. Guaranteed within the output limits of (V+ -0.3 V) to (V- +0.3 V). Tested with proprietary production test method.
 6. PWDN input has an internal pullup resistor to V+ of approximately 800 kΩ and is the major source of current consumption when PWDN is active (low).
 7. The device has a controlled start-up behavior due to its complex open loop gain characteristics. Start-up time applies to when supply voltage is applied or when PWDN is released.

ABSOLUTE MAXIMUM RATINGS

Parameter	Min	Typ	Max	Unit
Supply Voltage [(V+) - (V-)]			6.8	V
Input Voltage	V- -0.3		V+ +0.3	V
Storage Temperature Range		-65	+150	°C

2. TYPICAL PERFORMANCE PLOTS

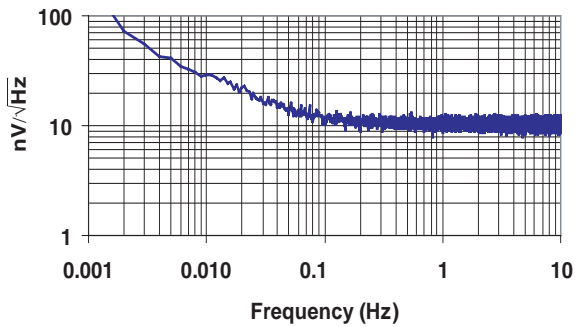

Figure 1. Noise vs. Frequency (Measured)

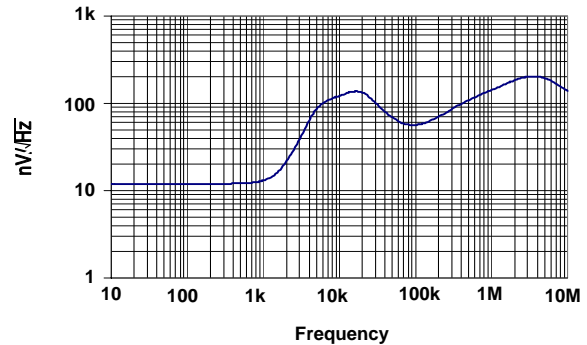

Figure 2. Noise vs. Frequency

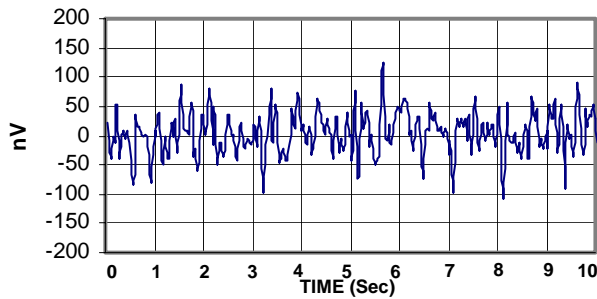

Figure 3. 0.01 Hz to 10 Hz Noise

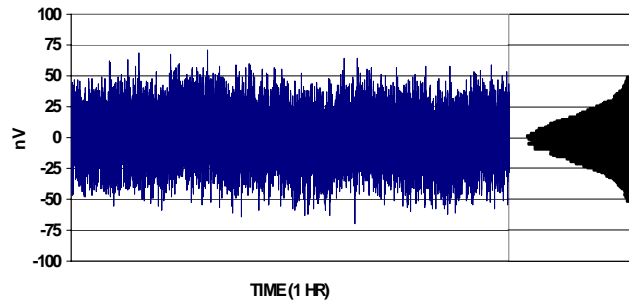

Figure 4. Offset Voltage Stability (DC to 3.2 Hz)

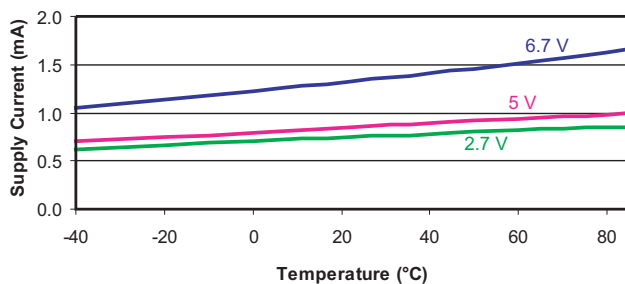

Figure 5. Supply Current vs. Temperature, 3011

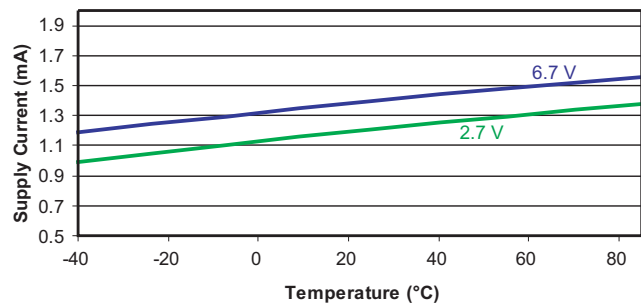

Figure 6. Supply Current vs. Temperature, 3012

Typical Performance Plots (Cont.)

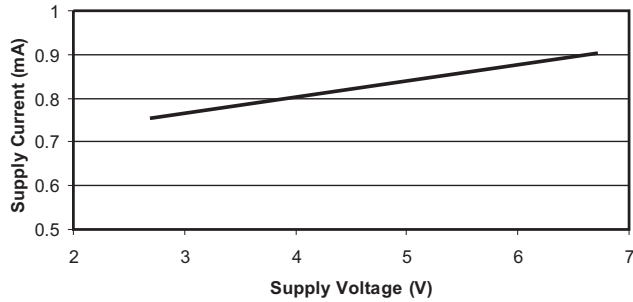

Figure 7. Supply Current vs. Voltage, 3011

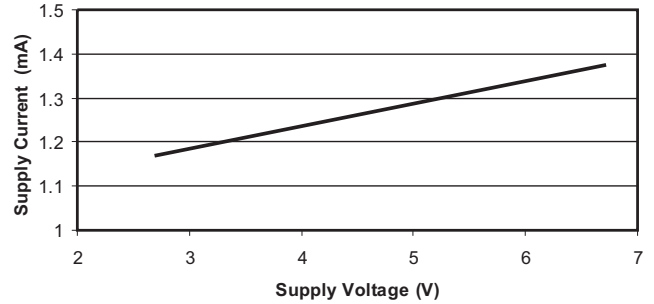

Figure 8. Supply Current vs. Voltage, 3012

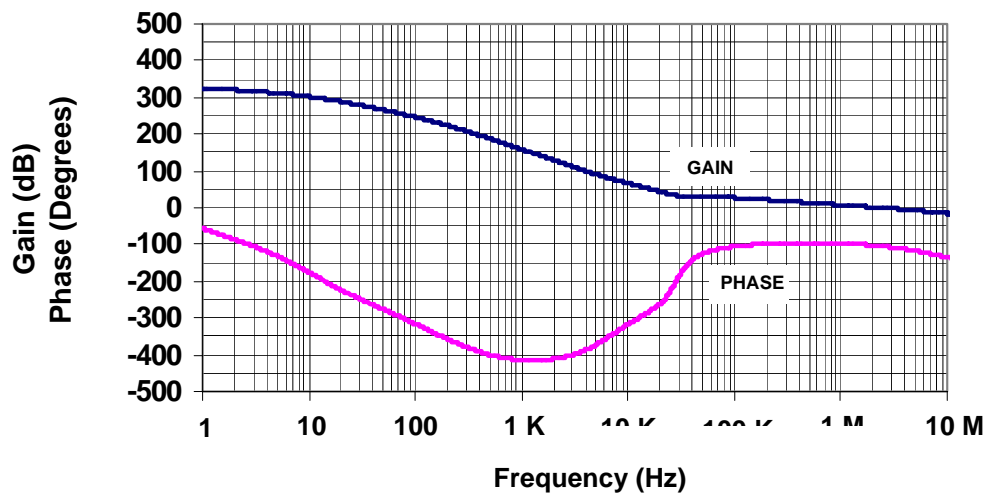
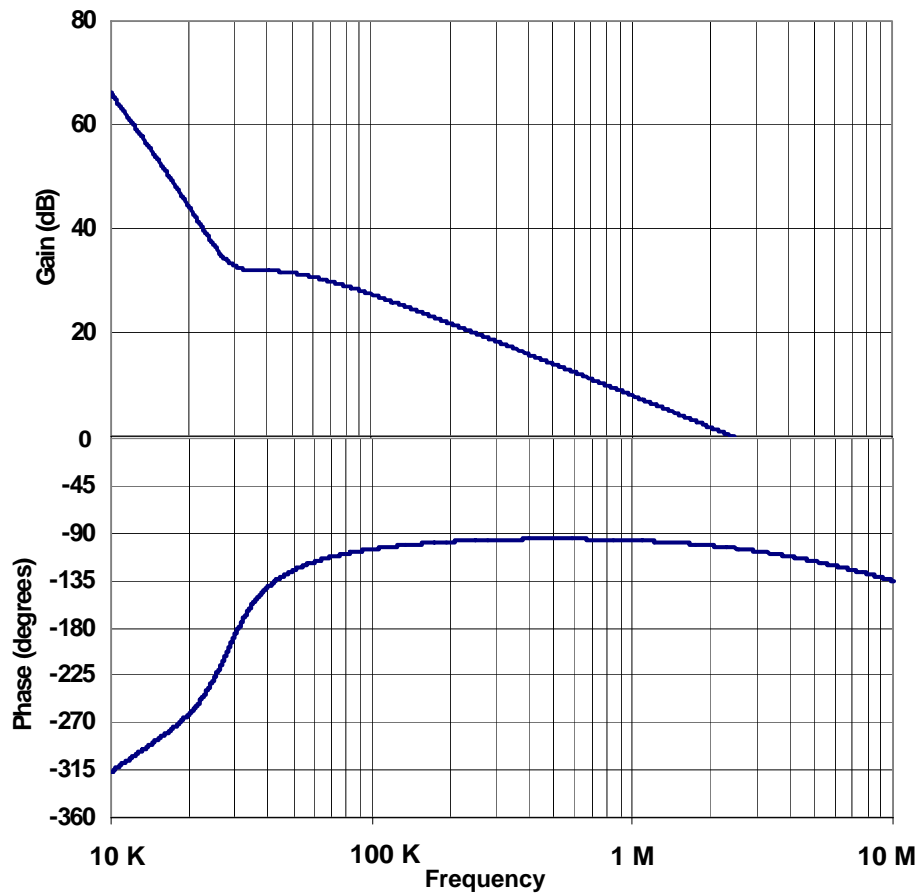
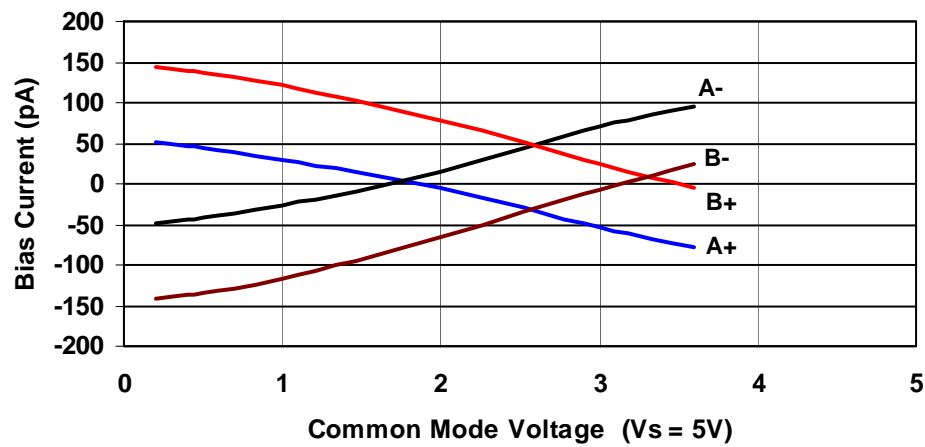
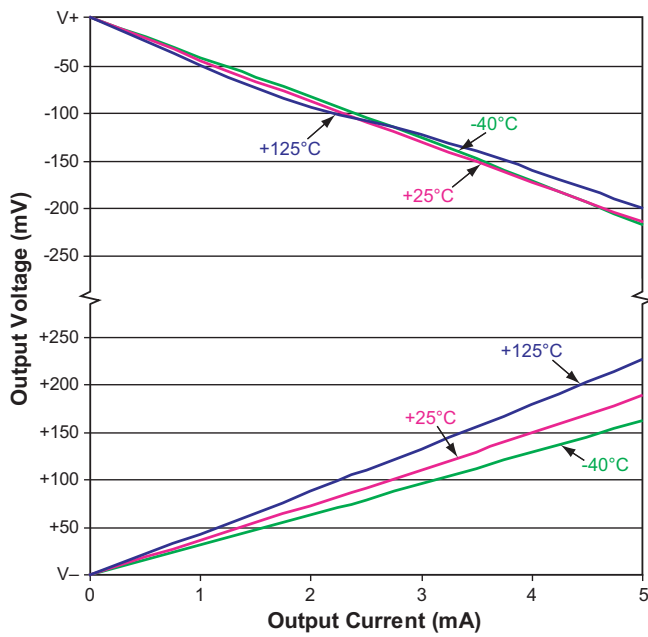
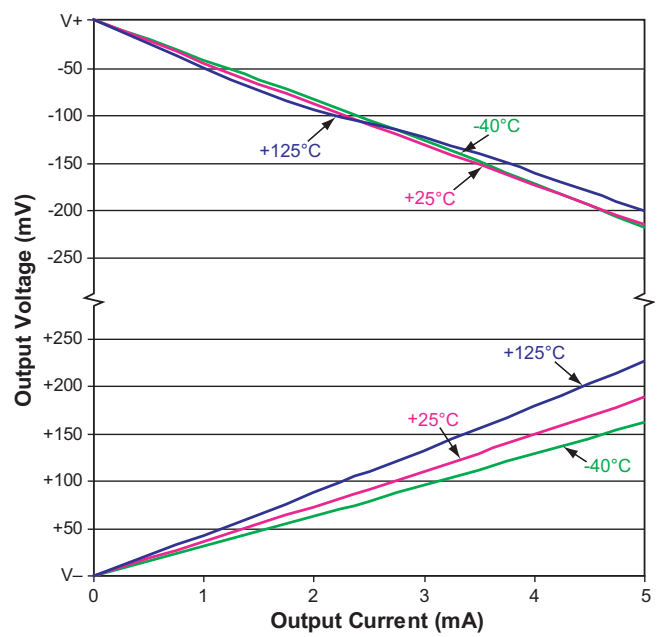

Figure 9. Open Loop Gain and Phase vs Frequency

Typical Performance Plots (Cont.)

Figure 10. Open Loop Gain and Phase vs Frequency (Expand-

Figure 11. Input Bias Current vs Common Mode Voltage (CS3012)

Typical Performance Plots (Cont.)

Figure 12. Voltage Swing vs. Output Current (2.7 V)

Figure 13. Voltage Swing vs. Output Current (5 V)

3. CS3011/CS3012 OVERVIEW

The CS3011/CS3012 amplifiers are designed for precision measurement of signals from DC to 1 kHz when operating from a supply voltage of +2.7 V to +6.7 V (± 1.35 to ± 3.35 V). The amplifiers are designed with a patented architecture that utilizes multiple amplifier stages to yield very high open loop gain at frequencies of 1 kHz and below. The amplifiers yield low noise and low offset drift

while consuming relatively low supply current. An increase in noise floor above 1 kHz is the result of intermediate stages of the amplifier being operated at very low currents. The amplifiers are intended for amplifying small signals with large gains in applications where the output of the amplifier can be band-limited to frequencies below 1 kHz.

3.1 Open Loop Gain and Phase Response

Figure 14 illustrates the open loop gain and phase response of the CS3011/CS3012. The gain slope of the amplifier is about -100 dB/decade between 500 Hz and 30 kHz and transitions to -20 dB/de-

cade between 30 kHz and its unity gain crossover frequency at about 2.4 MHz. Phase margin at unity gain is about 70 degrees; gain margin is about 20 dB.

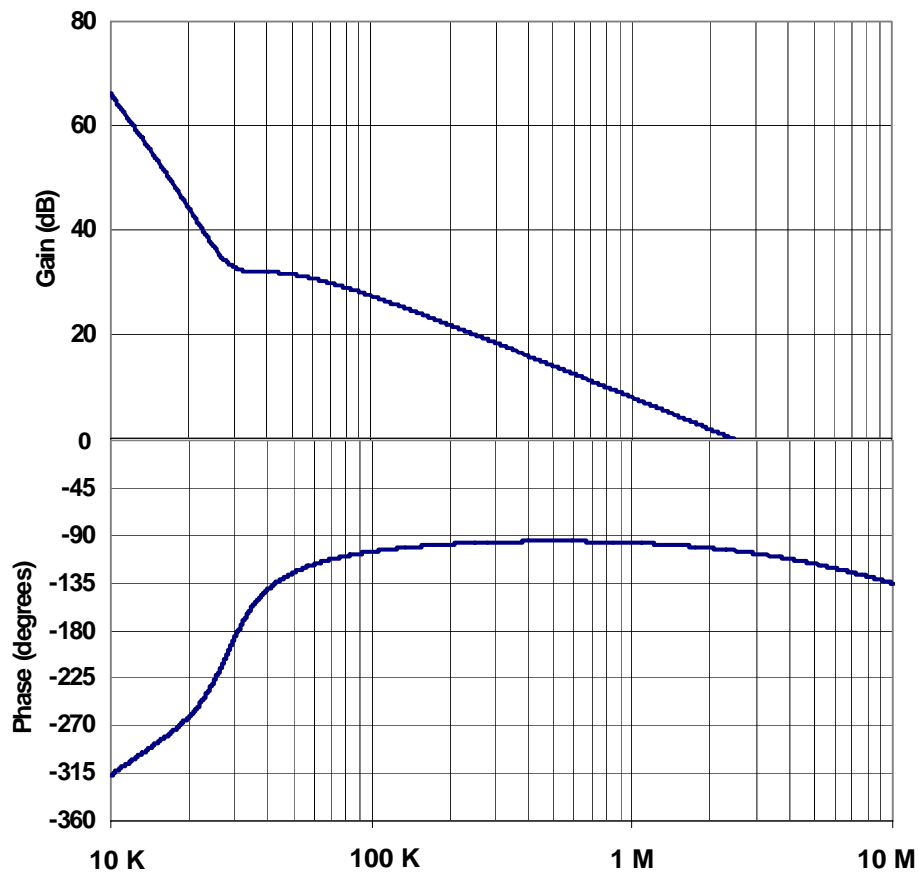

Figure 14. CS3011/CS3012 Open Loop Gain and Phase Response

3.2 Open Loop Gain and Stability Compensation

3.2.1 Discussion

The CS3011 and CS3012 achieve ultra-high open loop gain. Figure 15 illustrates the amplifier in a non-inverting gain configuration. The open loop gain and phase plots indicate that the amplifier is stable for closed-loop gains less than 50 V/V. For a gain of 50, the phase margin is between 40° and 60° depending upon the loading conditions. As shown in Figure 16 on page 11, the op amp has an input capacitance at the + and – signal inputs of typically 50 pF. This capacitance adds an addition-

al pole in the loop gain transfer function at a frequency of $f = 1/(2\pi R \cdot C_{in})$ where R is the parallel combination of R1 and R2 ($R1 \parallel R2$). A higher value for R produces a pole at a lower frequency, thus reducing the phase margin. R1 is recommended to be less than or equal to 100 ohms, which results in a pole at 30 MHz or higher. If a higher value of R1 is desired, a compensation capacitor (C2) should be added in parallel with R2. C2 should be chosen such that $R2 \cdot C2 \geq R1 \cdot C_{in}$.

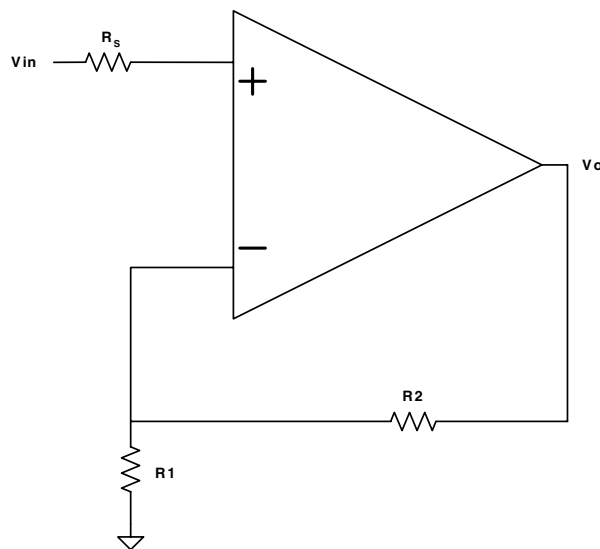

Figure 15. Non-Inverting Gain Configuration

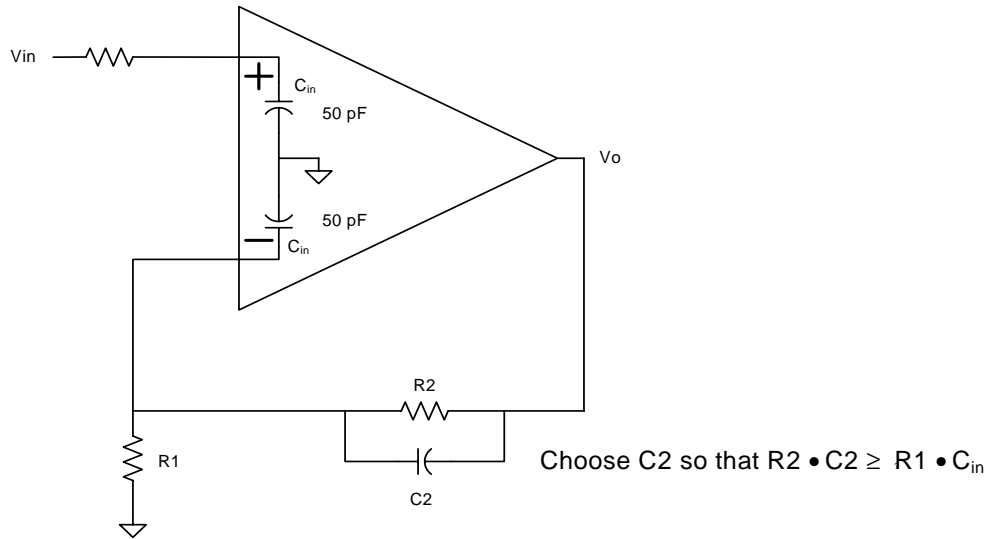

Figure 16. Non-Inverting Gain Configuration with Compensation

The feedback capacitor C2 is required for closed-loop gains greater than 50 V/V. The capacitor intro-

duces a pole and a zero in the loop gain transfer function.

$$T = \frac{-\left(1 + \frac{s}{z_1}\right)}{\left(1 + \frac{s}{p_1}\right)} A_{o1}$$

$$P_1 = \frac{1}{2\pi(R_1 \parallel R_2)C_2} \cong \frac{1}{2\pi(R_1 C_2)} \quad \text{for} \quad R_2 \gg R_1$$

$$Z_1 = \frac{1}{2\pi(A \times R_1)C_2} \quad \text{where} \quad |A| = \frac{R_2}{R_1}$$

$$Z_1 = \frac{1}{2\pi(R_2)C_2}$$

This indicates that the separation of the pole and the zero is governed by the closed loop gain. It is required that the zero falls on the steep slope (-100 dB/decade) of the loop gain plot so that

there is some gain higher than 0 dB (typically 20 dB) at the hand-over frequency (the frequency at which the slope changes from -100 dB/decade to -20 dB/decade).

The loop gain plot shown in Figure 17 illustrates the unity gain configuration, and indicates how this is modified when using the amplifier in a higher gain configuration with compensation. If it is configured for higher gain, for example, 60 dB, the x-axis will move up by 60 dB (line B). Capacitor C2 adds a zero and a pole. The modified plot indicates the effects of introducing the pole and zero due to capacitor C2. The pole can be located at any frequency higher than the hand-over frequency, the zero has to be at a frequency lower than the hand-over frequency so as to provide adequate gain

margin. The separation between the pole and the zero is governed by the closed loop gain. The zero (z_1) occurs at the intersection of the -100 dB/decade and -80 dB/decade slopes. The point X in the figure should be at closed loop gain plus 20 dB gain margin. The value for $C2 = 1/(2\pi R1 p1)$. Using $p1 = 500$ kHz works very well and is independent of gain. As the closed loop gain is changed, the zero location is also modified if R1 remains fixed. Capacitor C2 can be increased in value to limit the amplifier's rising noise above 1 kHz.

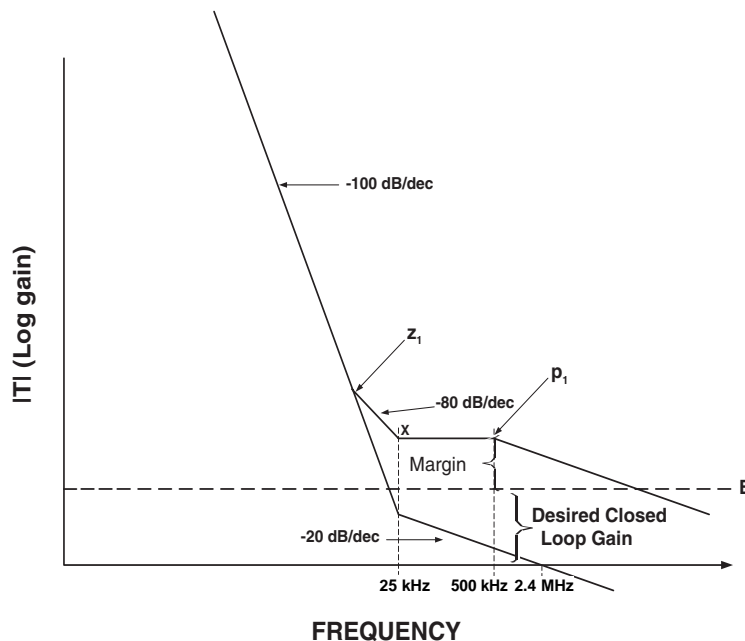

Figure 17. Loop Gain Plot: Unity Gain and with Pole-Zero Compensation

3.2.2 Gain Calculations Summary and Recommendations

Condition #1: $|A_v| \leq 50$ and $R1 \leq 100 \Omega$

The Opamp is inherently stable for $|A_v| \leq 50$ and $R1 \leq 100 \Omega$. No C2 compensation capacitor across R2 is required.

- $|A_v| = 1$ configuration has 70° phase margin and 20 dB gain margin.
- $|A_v| = 50$ configuration has phase margin between 40° for $C_{LOAD} \leq 100$ pF and 60° for $C_{LOAD} = 0$ pF.

Condition #2: $|A_v| \leq 50$ and $R1 > 100 \Omega$

Compensation capacitor C2 across R2 is required. Calculate C2 using the following formula:

- $C2 \geq (R1 \cdot C_{in}) / R2$, where $C_{in} = 50$ pF

Condition #3: $|A_v| > 50$

Compensation capacitor C2 across R2 is required. Calculate and verify a value for C2 using the following steps.

Calculate the Compensation Capacitor Value:

- 1) Calculate a value for C2 using the following formula:

$$C2 = 1 / [2\pi (R1 || R2) \cdot P1], \text{ where } P1 = 1 \text{ MHz}$$

To simplify the calculation, set the pole of the filter to $P1 = 1$ MHz. P1 must be set higher than the opamp's internal 50 kHz crossover frequency.

- 2) Calculate a second value for C2 using the following formula:

$$C2 \geq (R1 \cdot C_{in}) / R2, \text{ where } C_{in} = 50 \text{ pF}$$

- 3) Use the larger of the two values calculated in steps 1 & 2.

Verify the Opamp Compensation:

Verify the opamp compensation using the open-loop gain and phase response Bode plot in [Figure 14](#). Plot the calculated closed loop gain transfer function and verify the following design criteria are met:

- Pole $P1 >$ opamp internal 50 kHz crossover frequency
 - $P1 = 1 / [2\pi (R1 || R2) \cdot C2]$, where $P1 = 1$ MHz
 - To simplify the calculation, set the pole to $P1 = 1$ MHz.
- $Z1 <$ opamp internal 50 kHz crossover frequency
 - $Z1 = 1 / (2\pi R2 \cdot C2)$
- Gain margin above the open-loop gain transfer function is required. A gain margin of +20 dB above the open loop gain transfer function is optimal.

3.3 Powerdown (PDWN)

The CS3011 single amplifier provides a powerdown function on pin 1. If this pin is left open the amplifier will operate normally. If the powerdown is asserted low, the amplifier enters a powered down state. There is a pull-up resistor (approximately 800 k ohm) inside the amplifier from pin 1 to the V+ supply. The current through this pull-up resistor is the main source of current drain in the powerdown state.

3.4 Applications

The CS3011 and CS3012 amplifiers are optimum for applications that require high gain and low drift. Figure 18 illustrates a thermopile amplifier with a gain of 650 V/V. The thermopile outputs only a few millivolts when subjected to infrared radiation. The amplifier is compensated and bandlimited by C1 in combination with R2.

Figure 19 on page 14 illustrates a load cell bridge amplifier with a gain of 768 V/V. The load cell is ex-

cited with +5 V and has a 1 mV/V sensitivity. Its full scale output signal is amplified to produce a fully differential ± 3.8 V into the CS5510/12 A/D converter. This circuit operates from +5 V.

A similar circuit operating from +3 V can be constructed using the CS5540/CS5541 A/D converters.

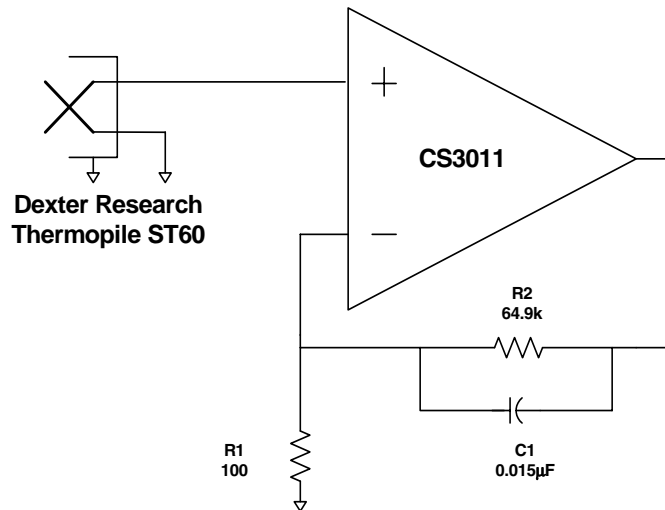
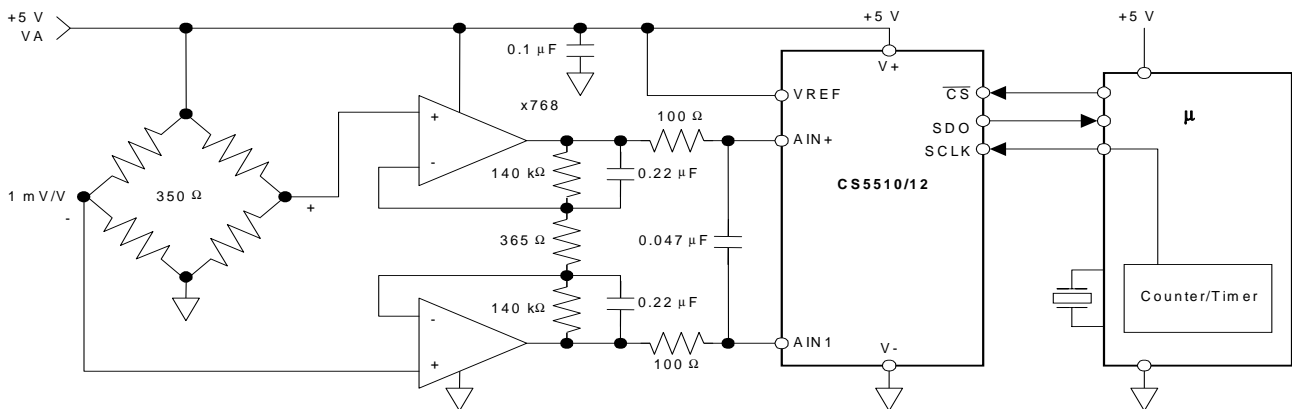

Figure 18. Thermopile Amplifier with a Gain of 650 V/V



SCLK = 10 kHz to 100 kHz
(32.768 nominal)

Figure 19. Load Cell Bridge Amplifier and A/D Converter

4. ORDERING INFORMATION

Model	Temperature	Package
CS3011-IS	-40 to +85 °C	8-pin SOIC
CS3011-ISZ (lead free)		
CS3012-IS		
CS3012-ISZ (lead free)		

5. ENVIRONMENTAL, MANUFACTURING, & HANDLING INFORMATION

Model Number	Peak Reflow Temp	MSL Rating*	Max Floor Life
CS3011-IS	240 °C	2	365 Days
CS3011-ISZ (lead free)	260 °C		
CS3012-IS	240 °C		
CS3012-ISZ (lead free)	260 °C		

* MSL (Moisture Sensitivity Level) as specified by IPC/JEDEC J-STD-020.

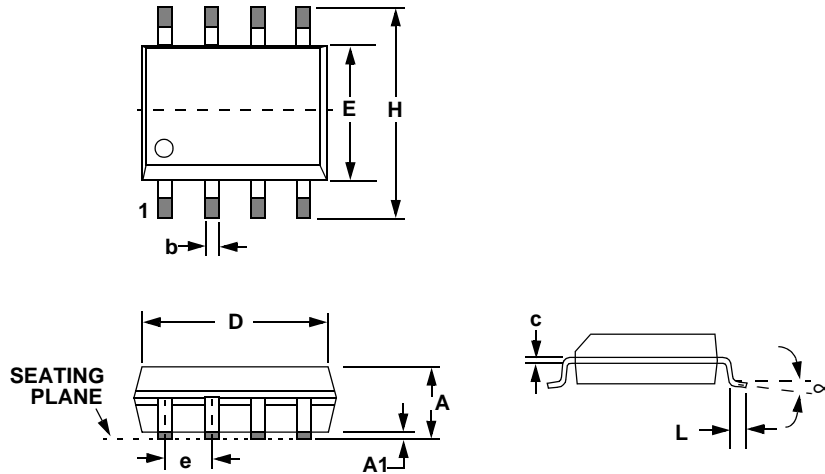
6. PACKAGE DRAWING
8L SOIC (150 MIL BODY) PACKAGE DRAWING

DIM	INCHES		MILLIMETERS	
	MIN	MAX	MIN	MAX
A	0.053	0.069	1.35	1.75
A1	0.004	0.010	0.10	0.25
B	0.013	0.020	0.33	0.51
C	0.007	0.010	0.19	0.25
D	0.189	0.197	4.80	5.00
E	0.150	0.157	3.80	4.00
e	0.040	0.060	1.02	1.52
H	0.228	0.244	5.80	6.20
L	0.016	0.050	0.40	1.27
∞	0°	8°	0°	8°

JEDEC # : MS-012

7. REVISION HISTORY

Revision	Date	Changes
F2	SEP 2004	Added lead-free device ordering information.
F3	AUG 2005	Added MSL specifications. Updated legal notice. Added leaded (Pb) devices.
F4	AUG 2006	Updated <i>Typical Performance Plots</i> . Removed Powerdown feature.
F5	NOV 2007	Added additional information regarding open-loop and gain stability compensation.

Contacting Cirrus Logic Support

For all product questions and inquiries contact a Cirrus Logic Sales Representative.

To find the one nearest to you go to www.cirrus.com

IMPORTANT NOTICE

Cirrus Logic, Inc. and its subsidiaries ("Cirrus") believe that the information contained in this document is accurate and reliable. However, the information is subject to change without notice and is provided "AS IS" without warranty of any kind (express or implied). Customers are advised to obtain the latest version of relevant information to verify, before placing orders, that information being relied on is current and complete. All products are sold subject to the terms and conditions of sale supplied at the time of order acknowledgment, including those pertaining to warranty, indemnification, and limitation of liability. No responsibility is assumed by Cirrus for the use of this information, including use of this information as the basis for manufacture or sale of any items, or for infringement of patents or other rights of third parties. This document is the property of Cirrus and by furnishing this information, Cirrus grants no license, express or implied under any patents, mask work rights, copyrights, trademarks, trade secrets or other intellectual property rights. Cirrus owns the copyrights associated with the information contained herein and gives consent for copies to be made of the information only for use within your organization with respect to Cirrus integrated circuits or other products of Cirrus. This consent does not extend to other copying such as copying for general distribution, advertising or promotional purposes, or for creating any work for resale.

CERTAIN APPLICATIONS USING SEMICONDUCTOR PRODUCTS MAY INVOLVE POTENTIAL RISKS OF DEATH, PERSONAL INJURY, OR SEVERE PROPERTY OR ENVIRONMENTAL DAMAGE ("CRITICAL APPLICATIONS"). CIRRUS PRODUCTS ARE NOT DESIGNED, AUTHORIZED OR WARRANTED FOR USE IN PRODUCTS SURGICALLY IMPLANTED INTO THE BODY, AUTOMOTIVE SAFETY OR SECURITY DEVICES, LIFE SUPPORT PRODUCTS OR OTHER CRITICAL APPLICATIONS. INCLUSION OF CIRRUS PRODUCTS IN SUCH APPLICATIONS IS UNDERSTOOD TO BE FULLY AT THE CUSTOMER'S RISK AND CIRRUS DISCLAIMS AND MAKES NO WARRANTY, EXPRESS, STATUTORY OR IMPLIED, INCLUDING THE IMPLIED WARRANTIES OF MERCHANTABILITY AND FITNESS FOR PARTICULAR PURPOSE, WITH REGARD TO ANY CIRRUS PRODUCT THAT IS USED IN SUCH A MANNER. IF THE CUSTOMER OR CUSTOMER'S CUSTOMER USES OR PERMITS THE USE OF CIRRUS PRODUCTS IN CRITICAL APPLICATIONS, CUSTOMER AGREES, BY SUCH USE, TO FULLY INDEMNIFY CIRRUS, ITS OFFICERS, DIRECTORS, EMPLOYEES, DISTRIBUTORS AND OTHER AGENTS FROM ANY AND ALL LIABILITY, INCLUDING ATTORNEYS' FEES AND COSTS, THAT MAY RESULT FROM OR ARISE IN CONNECTION WITH THESE USES.

Cirrus Logic, Cirrus, and the Cirrus Logic logo designs are trademarks of Cirrus Logic, Inc. All other brand and product names in this document may be trademarks or service marks of their respective owners.