

Wideband, High Impedance Operational Amplifiers

Features

- Wide Bandwidth 12MHz
- High Input Impedance 500M Ω
- Low Input Bias Current 1nA
- Low Input Offset Current 1nA
- Low Input Offset Voltage 0.5mV
- High Gain 150kV/V
- High Slew Rate 7V/ μ s
- Output Short Circuit Protection
- Unity Gain Stable

Description

HA-2600/2602/2605 are internally compensated bipolar operational amplifiers that feature very high input impedance (500M Ω , HA-2600) coupled with wideband AC performance. The high resistance of the input stage is complemented by low offset voltage (0.5mV, HA-2600) and low bias and offset current (1nA, HA-2600) to facilitate accurate signal processing. Input offset can be reduced further by means of an external nulling potentiometer. 12MHz unity gain-bandwidth, 7V/ μ s slew rate and 150kV/V open-loop gain enables HA-2600/2602/2605 to perform high-gain amplification of fast, wideband signals. These dynamic characteristics, coupled with fast settling times, make these amplifiers ideally suited to pulse amplification designs as well as high frequency (e.g. video) applications. The frequency response of the amplifier can be tailored to exact

Applications

- Video Amplifier
- Pulse Amplifier
- Audio Amplifiers and Filters
- High-Q Active Filters
- High-Speed Comparators
- Low Distortion Oscillators

design requirements by means of an external bandwidth control capacitor.

In addition to its application in pulse and video amplifier designs, HA-2600/2602/2605 is particularly suited to other high performance designs such as high-gain low distortion audio amplifiers, high-Q and wideband active filters and high-speed comparators. For more information, please refer to Application Note 515.

The HA-2600 and HA-2602 have guaranteed operation from -55 $^{\circ}$ C to +125 $^{\circ}$ C and are available in Metal Can and Ceramic Mini-DIP packages. Both are offered as /883 Military Grade; product and data sheets are available upon request. The HA-2605 has guaranteed operation from 0 $^{\circ}$ C to +75 $^{\circ}$ C and is available in Plastic and Ceramic Mini-DIP and Metal Can packages.

Pinouts

HA7-2600/02/05 (CERAMIC MINI-DIP)

HA3-2605 (PLASTIC MINI-DIP)

TOP VIEW

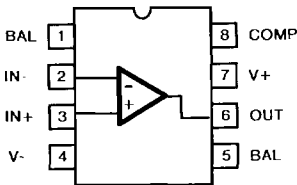

HA2-2600/02/05 (TO-99 METAL CAN)

TOP VIEW

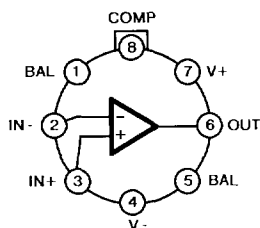

Schematic

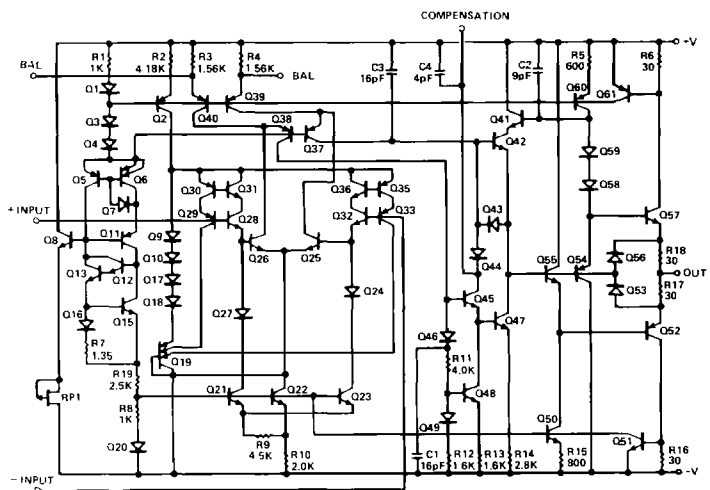

Absolute Maximum Ratings (Note 13)

Voltage Between V+ and V- Terminals	45.0V
Differential Input Voltage	±12.0V
Peak Output Current	Full Short Circuit Protection
Internal Power Dissipation	300mW
Maximum Junction Temperature	+175°C

Operating Temperature Ranges

HA-2600/HA-2602	-55°C ≤ T _A ≤ +125°C
HA-2605	0°C ≤ T _A ≤ +75°C
Storage Temperature Range	-65°C ≤ T _A ≤ +150°C
Lead Solder Temperature (10 Seconds)	275°C

Electrical Specifications V_S = ±15V D.C., Unless Otherwise Specified.

PARAMETER	TEMP	HA-2600 -55°C to +125°C			HA-2602 -55°C to +125°C			HA-2605 0°C to +75°C			UNITS
		MIN	TYP	MAX	MIN	TYP	MAX	MIN	TYP	MAX	
INPUT CHARACTERISTICS											
Offset Voltage	+25°C	-	0.5	4	-	3	5	-	3	5	mV
	Full	-	2	6	-	-	7	-	-	7	mV
Average Offset Voltage Drift	Full	-	5	-	-	5	-	-	5	-	μV/°C
Bias Current	+25°C	-	1	10	-	15	25	-	5	25	nA
	Full	-	10	30	-	-	60	-	-	40	nA
Offset Current	+25°C	-	1	10	-	5	25	-	5	25	nA
	Full	-	5	30	-	-	60	-	-	40	nA
Differential Input Resistance (Note 10)	+25°C	100	500	-	40	300	-	40	300	-	MΩ
Input Noise Voltage Density f ₀ = 1kHz	+25°C	-	11	-	-	11	-	-	11	-	nV/√Hz
Input Noise Current Density f ₀ = 1kHz	+25°C	-	0.16	-	-	0.16	-	-	0.16	-	pA/√Hz
Common Mode Range	Full	±11	±12	-	±11	±12	-	±11	±12	-	V
TRANSFER CHARACTERISTICS											
Large Signal Voltage Gain (Notes 1, 4)	+25°C	100K	150K	-	80K	150K	-	80K	150K	-	V/V
	Full	70K	-	-	60K	-	-	70K	-	-	V/V
Common Mode Rejection Ratio (Note 2)	Full	80	100	-	74	100	-	74	100	-	dB
Minimum Stable Gain	+25°C	1	-	-	1	-	-	1	-	-	V/V
Gain Bandwidth Product (Note 3)	+25°C	-	12	-	-	12	-	-	12	-	MHz
OUTPUT CHARACTERISTICS											
Output Voltage Swing (Note 1)	Full	±10	±12	-	±10	±12	-	±10	±12	-	V
Output Current (Note 4)	+25°C	±15	±22	-	±10	±18	-	±10	±18	-	mA
Full Power Bandwidth (Notes 4, 11)	+25°C	50	75	-	50	75	-	50	75	-	kHz
TRANSIENT RESPONSE (Note 8)											
Rise Time (Notes 1, 5, 6 & 7)	+25°C	-	30	60	-	30	60	-	30	60	ns
Overshoot (Notes 1, 5, 6 & 7)	+25°C	-	25	40	-	25	40	-	25	40	%
Slew Rate (Notes 1, 5, 7 & 12)	+25°C	±4	±7	-	±4	±7	-	±4	±7	-	V/μs
Settling Time (Notes 1, 5, & 14)	+25°C	-	1.5	-	-	1.5	-	-	1.5	-	μs
POWER SUPPLY CHARACTERISTICS											
Supply Current	+25°C	-	3	3.7	-	3	4	-	3	4	mA
Power Supply Rejection Ratio (Note 9)	Full	80	90	-	74	90	-	74	90	-	dB

NOTES:

- R_L = 2kΩ
- V_{CM} = ±10V
- V_{OUT} < 90mV
- V_{OUT} = ±10V
- C_L = 100pF
- V_{OUT} = ±200mV
- A_V = +1
- See Transient Response Test Circuits & Waveforms.
- ΔV_S = ±5V
- This parameter value guaranteed by design calculations.
- Full Power Bandwidth guaranteed by slew rate measurement:
FPBW = S.R./2πV_{PEAK}
- V_{OUT} = ±5V
- Absolute Maximum Ratings are limiting values applied individually beyond which the serviceability of the circuit may be impaired. Functional operation under any of these conditions is not necessarily implied.
- Settling time is characterized at A_V = -1 to 0.1% of a 10 Volt step.

Typical Performance Curves $V_S = \pm 15V$ D.C., $T_A = +25^\circ C$. Unless Otherwise Specified.

INPUT BIAS CURRENT AND OFFSET CURRENT AS A FUNCTION OF TEMPERATURE

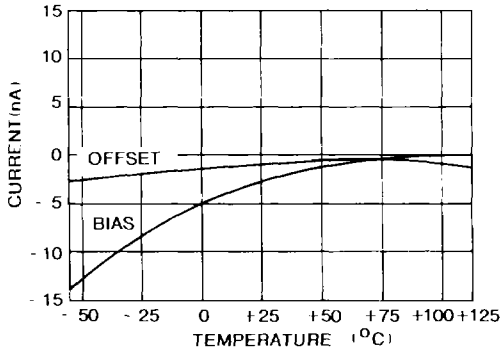

BROADBAND NOISE CHARACTERISTICS

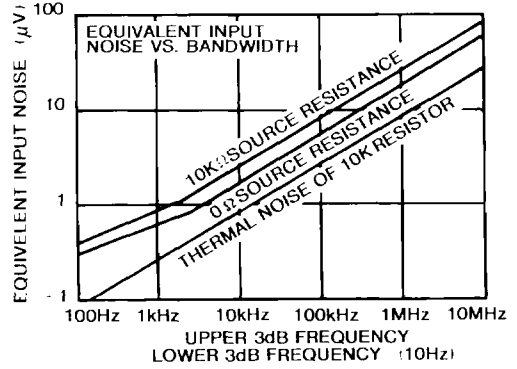

OPEN LOOP FREQUENCY AND PHASE RESPONSE

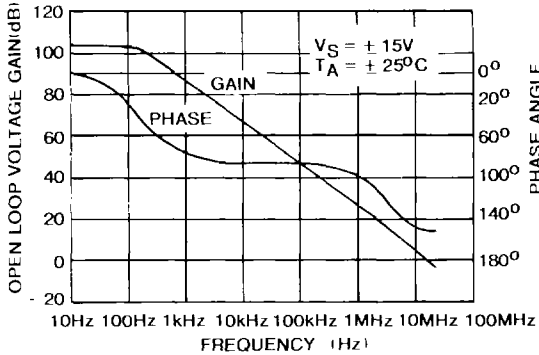

INPUT IMPEDANCE vs. TEMPERATURE, 100Hz

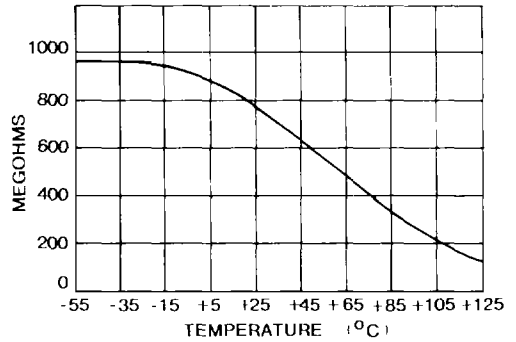

OUTPUT VOLTAGE SWING vs. FREQUENCY

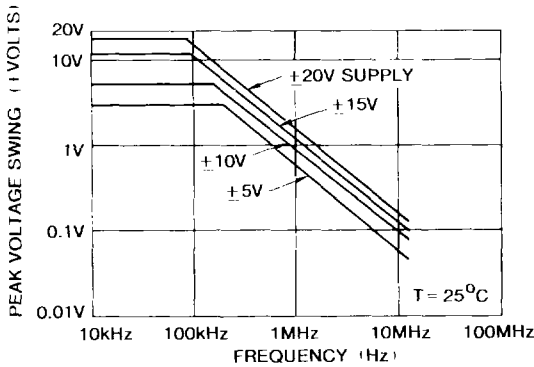

OPEN - LOOP FREQUENCY RESPONSE FOR VARIOUS VALUES OF CAPACITORS FOR COMPENSATION PIN TO GROUND

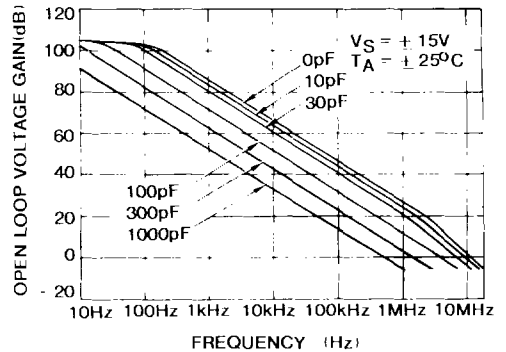

NOTE: External Compensation Components are not required for stability, but may be added to reduce bandwidth if desired. If External Compensation is used, also connect 100pF capacitor from output to ground.

Typical Performance Curves (Continued)

COMMON MODE VOLTAGE RANGE AS A FUNCTION OF SUPPLY VOLTAGE

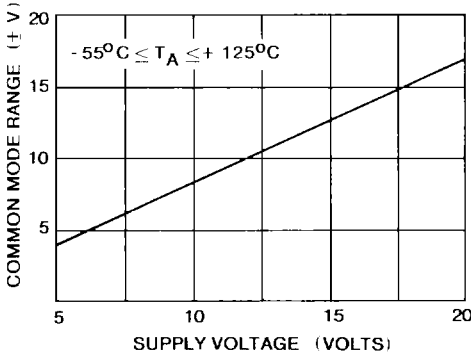

OPEN - LOOP VOLTAGE GAIN vs. TEMPERATURE

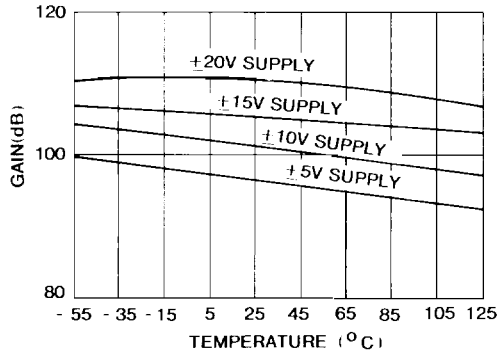

COMMON MODE REJECTION RATIO vs. FREQUENCY

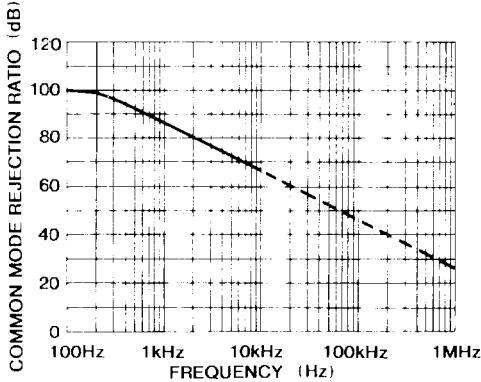

NOISE DENSITY vs. FREQUENCY

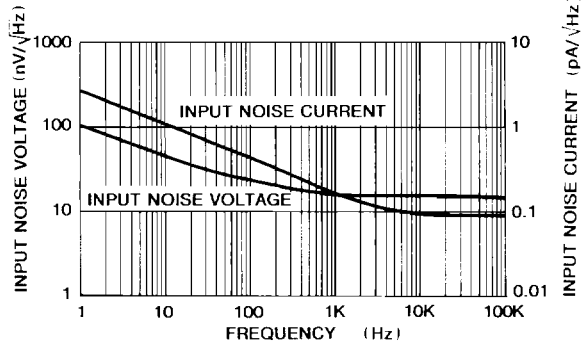

Test Circuits

TRANSIENT RESPONSE

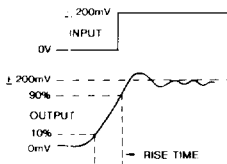

SLEW RATE

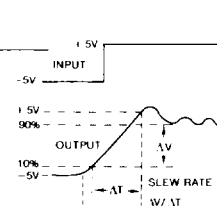

SLEW RATE AND TRANSIENT RESPONSE

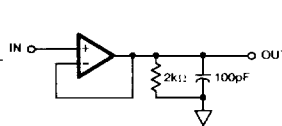

SUGGESTED V_{OS} ADJUSTMENT AND COMPENSATION HOOK-UP

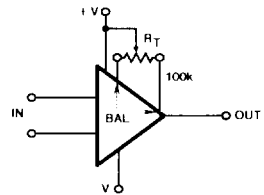

NOTE: Measured on both positive and negative transitions from 0 to +200mV and 0 to -200mV at output.

Tested Offset Adjustment is |V_{OS} + 1mV| minimum referred to output. Typical range is ±10mV with R_T = 100kΩ.

Typical Applications

PHOTO - CURRENT TO VOLTAGE CONVERTER

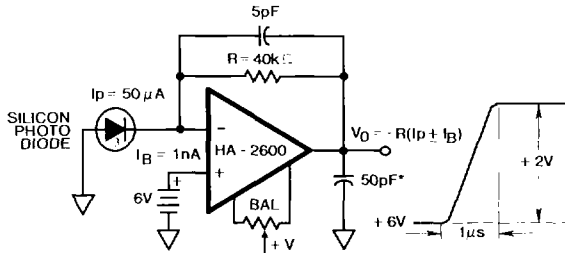

FEATURES:

1. Constant cell voltage
2. Minimum bias current error

REFERENCE VOLTAGE AMPLIFIER

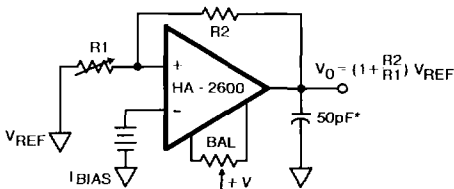

FEATURES:

1. Minimum bias current in reference cell
2. Short circuit protection

SAMPLE - AND - HOLD

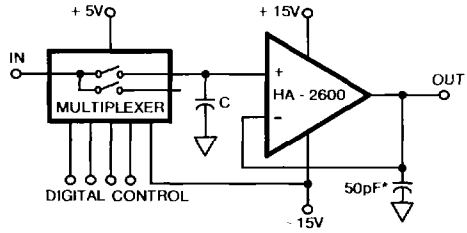

Drift rate $\frac{I_{bias}}{C}$ If C = 1000pF
Drift = 0.01V/ms Max

VOLTAGE FOLLOWER

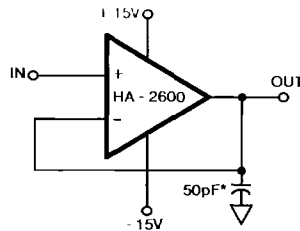

$Z_{IN} = 10^{12}$ Min. B.W. = 12MHz Typ.
 $Z_{OUT} = 0.01$ Max. Output Swing = $\pm 10V$ Min. to 50kHz
Slew Rate = 4V/ μ s Min.

* A small load capacitance is recommended in all applications where practical to prevent possible high frequency oscillations resulting from external wiring parasitics. Capacitance up to 100pF has negligible effect on the bandwidth or slew rate.

Die Characteristics

Transistor Count	140
Die Dimensions	73 x 52 x 19 mils
Substrate Potential	Unbiased

Thermal Constants ($^{\circ}C/W$)	θ_{ja}	θ_{jc}
HA2-Metal Can (-2, -5, -7)	202	55
HA2-Metal Can (-8, /883)	161	48
HA3-Plastic DIP (-5)	83	33
HA4-Ceramic LCC (/883)	96	35
HA7-Ceramic DIP (-2, -5, -7)	204	112
HA7-Ceramic DIP (-8, /883)	81	32