

Features

- Low Supply Current..... $< 200\mu\text{A}/\text{Amplifier}$
- Dual Supply Voltage Range..... $\pm 1.5\text{V}$ to $\pm 15\text{V}$
- Single Supply Voltage Range..... 3V to 30V
- High Slew Rate..... $6\text{V}/\mu\text{s}$
- Low V_{OS} Drift..... $3\mu\text{V}/^\circ\text{C}$
- Low Noise..... $15\text{nV}/\sqrt{\text{Hz}}$
- Dielectric Isolation

Description

The HA-5151/52/54 series is a group of dielectrically isolated bipolar amplifiers designed to provide excellent AC performance while drawing less than $200\mu\text{A}$ of supply current per amplifier. These unity gain stable amplifiers are especially well suited for portable and lightweight equipment where available power is limited.

The HA-5151/52/54 series combines superior low power AC performance with DC precision not usually found in general purpose amplifiers. The DC performance is centered around low input offset voltage (0.5mV), low offset voltage drift ($3\mu\text{V}/^\circ\text{C}$), and low input bias current (70nA). This is combined with a very low input noise voltage of $15\text{nV}/\sqrt{\text{Hz}}$ at 1kHz .

The AC performance of the HA-5151/52/54 series surpasses that of typical low power amplifiers with $6\text{V}/\mu\text{s}$

Applications

- Portable Instruments
- Meter Amplifiers
- Telephone Headsets
- Microphone Amplifiers
- Remote Sensor/Transmitter
- Battery Powered Equipment
- For Further Design Ideas See App. Note 544.

slow rate and a full power bandwidth of 95kHz . This makes the HA-5151/52/54 series an excellent choice for virtually all audio processing applications as well as remote sensor/transmitter designs requiring both low power and high speed. The suitability of the HA-5151/52/54 series for remote and low power operation is further enhanced by the wide range of supply voltages ($\pm 1.5\text{V}$ to $\pm 15\text{V}$) as well as single supply operation (3V to 30V). These parts are also tested and guaranteed at both ± 15 and single ended $+5\text{V}$ supplies.

These amplifiers are available in singles (HA-5151, Can or Mini-DIP), duals (HA-5152, Can or Mini-DIP) or quads (HA-5154, 14 pin DIP), as well as over both the commercial (0°C to $+75^\circ\text{C}$) and military (-55°C to $+125^\circ\text{C}$) temperature ranges. These amplifiers also carry industry standard pinouts which allow the HA-5151/52/54's to be interchangeable with most other operational amplifiers. For military grade product refer to the HA-5151, 5152, 5154/883 data sheets.

Pinouts

HA3-5151 (PLASTIC MINI-DIP)
HA7-5151 (CERAMIC MINI-DIP)

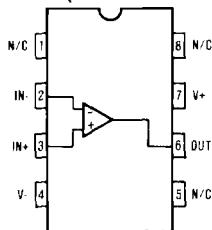

HA2-5151 (TO-99 METAL CAN)

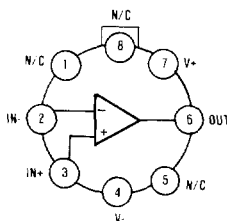

TOP VIEWS

HA3-5152 (PLASTIC MINI-DIP)
HA7-5152 (CERAMIC MINI-DIP)

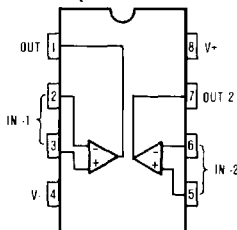

HA2-5152 (TO-99 METAL CAN)

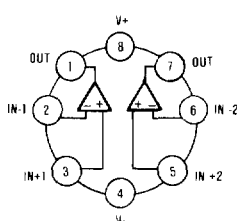

HA1-5154 (CERAMIC DIP)
HA3-5154 (PLASTIC DIP)

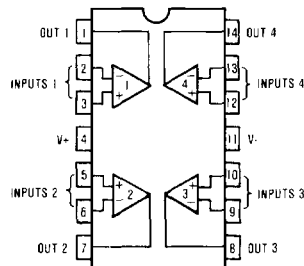

Specifications HA-5151/52/54

Absolute Maximum Ratings (Note 1)

Voltage Between V+ and V- Terminals 35V
 Differential Input Voltage $\pm 7V$
 Output Current S/C Protected
 Internal Power Dissipation 500mW

Operating Temperature Range

HA-5151/52/54-5 $0^{\circ}C \leq T_A \leq +75^{\circ}C$
 HA-5151/52/54-2 $-55^{\circ}C \leq T_A \leq +125^{\circ}C$
 Storage Temperature Range $-65^{\circ}C \leq T_A \leq +150^{\circ}C$

Electrical Specifications $R_S = 100\Omega$, $C_L \leq 10pF$ Unless Otherwise Specified.

PARAMETER	TEMP	V+ = +5V, V- = 0V			V+ = +15V, V- = -15V			UNITS
		MIN	TYP	MAX	MIN	TYP	MAX	
INPUT CHARACTERISTICS								
Offset Voltage	+25°C		0.5	3		0.5	3	mV
	Full			4			4	mV
Average Offset Voltage Drift			3			3		$\mu V/^{\circ}C$
Bias Current	+25°C		100	250		100	250	nA
	Full			400			400	nA
Offset Current	+25°C		5	50		5	50	nA
	Full			80			80	nA
Common Mode Range		0 to 3			± 10			V
Differential Input Resistance	+25°C		1.5			1.5		M Ω
Input Noise Voltage (f = 1kHz)	+25°C		14.8			14.8		nV/\sqrt{Hz}
Input Noise Current (f = 1kHz)	+25°C		0.25			0.25		pA/\sqrt{Hz}
TRANSFER CHARACTERISTICS								
Large Signal Voltage Gain (Notes 2, 4)	+25°C	50k	100k		50k	100k		V/V
	Full	25k	50k		25k	50k		V/V
Common Mode Rejection Ratio (Note 7)		80	105		80	105		dB
Bandwidth (Notes 2, 3)	+25°C		1.3			1.3		MHz
OUTPUT CHARACTERISTICS								
Output Voltage Swing (Notes 2, 10)	+25°C	1 to 3.2	0.7 to 3.5		± 10	± 13		V
	Full	1.2 to 2.9	0.9 to 3.2		± 10	± 13		V
Full Power Bandwidth (Notes 2, 4, 8)	+25°C		700			95		kHz
TRANSIENT RESPONSE (Notes 2, 3)								
Rise Time	+25°C		300			300		ns
Slew Rate (Note 6)	+25°C	2	4.5		4	6		V/ μs
Settling Time (Note 5)	+25°C		5			5		μs
POWER SUPPLY CHARACTERISTICS								
Supply Current	+25°C		200	250		200	250	μA /Amp
	Full			275			275	μA /Amp
Power Supply Rejection Ratio (Note 9)		80	105		80	105		dB

NOTES

- Absolute maximum ratings are limiting values, applied individually beyond which the serviceability of the circuit may be impaired. Functional operability under any of these conditions is not necessarily implied.
- $R_L = 10k\Omega$
- $C_L = 100pF$
- $V_O = 1.4$ to $2.5V$ for $V_{CC} = +5, 0V$; $V_O = \pm 10V$ for $V_{CC} = \pm 15V$.
- Settling Time is specified to 0.1% of final value for a 3V output step and $A_V = -1$. For $V_{CC} = +5, 0V$, output step = 10V for $V_{CC} = \pm 15V$.
- Maximum input slew rate = $25V/\mu s$
- $V_{CM} = 0$ to $3V$ for $V_{CC} = +5, 0V$. $V_{CM} = \pm 10V$ for $V_{CC} = \pm 15V$
- Full Power Bandwidth is guaranteed by equation:

$$\text{Full Power Bandwidth} = \frac{\text{Slew Rate}}{2\pi V \text{ Peak}}$$
- $\Delta V_S = \pm 10V$ for $V_{CC} = +5, 0V$; $\Delta V_S = \pm 5V$ for $V_{CC} = \pm 15V$.
- For $V_{CC} = +5, 0V$ terminate R_L at $+2.5V$

Test Circuits

SLEW RATE AND TRANSIENT RESPONSE TEST CIRCUIT

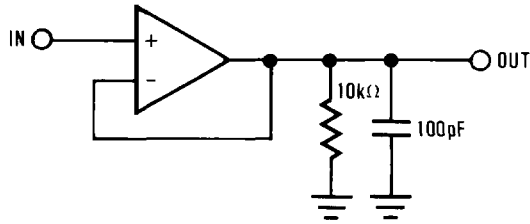

LARGE SIGNAL RESPONSE

Vertical Scale: (Volts: Input = 5V/Div.)
 (Volts: Output = 2V/Div.)
 Horizontal Scale: (Time: 5μs/Div.)

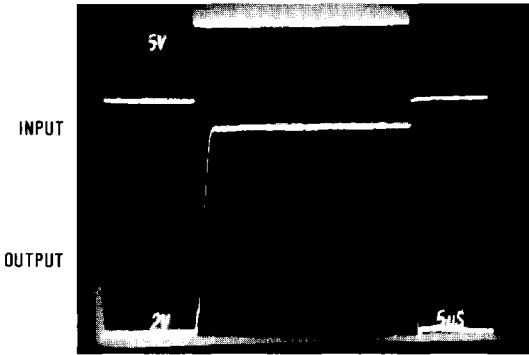

+VSUPPLY = +15V, -VSUPPLY = -15V

SMALL SIGNAL RESPONSE

Vertical Scale: (Volts: Input = 100mV/Div.)
 (Volts: Output = 50mV/Div.)
 Horizontal Scale: (Time: 5μs/Div.)

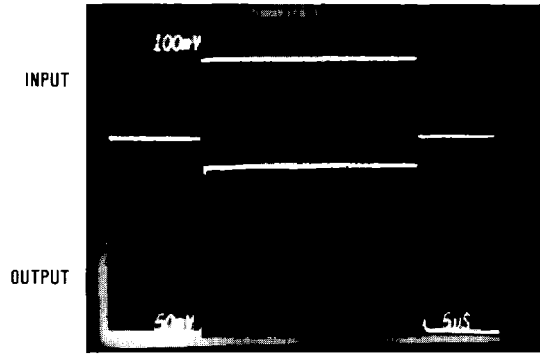

+VSUPPLY = +15V, -VSUPPLY = -15V

Vertical Scale: (Volts: Input = 1V/Div.)
 (Volts: Output = 1V/Div.)
 Horizontal Scale: (Time: 5μs/Div.)

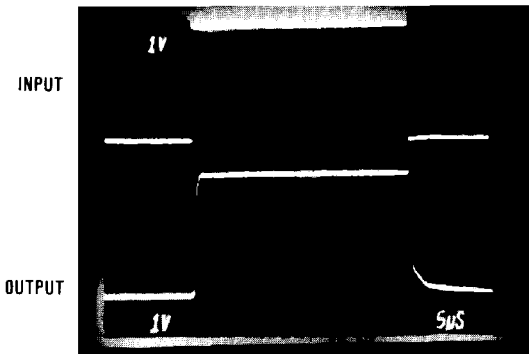

+VSUPPLY = +5V, -VSUPPLY = 0V

Vertical Scale: (Volts: Input = 100mV/Div.)
 (Volts: Output = 50mV/Div.)
 Horizontal Scale: (Time: 5μs/Div.)

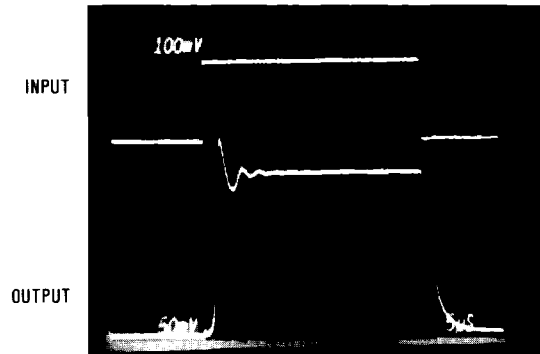

+VSUPPLY = +5V, -VSUPPLY = 0V

Typical Characteristics

SLEW RATE vs. TEMPERATURE

Normalized to Unity at +25°C, 6 Representative Units

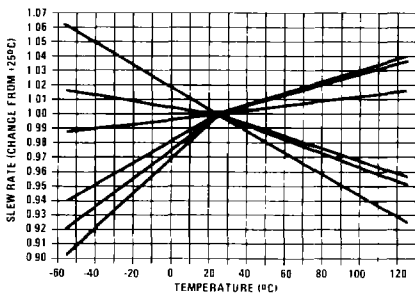

NOISE SPECTRAL DENSITY

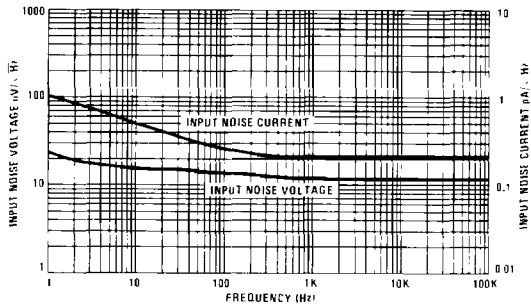

PEAK-TO-PEAK NOISE 0.1Hz TO 10Hz

$T_A = +25^\circ\text{C}$, $A_V = 1000\text{V}\cdot\text{V}$

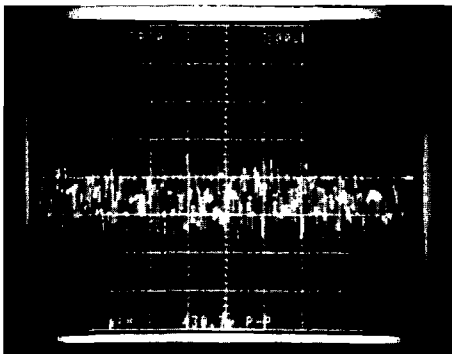

Horizontal Scale: (1sec div)
Vertical Scale: (100 μs div)
430nV_{p-p} RTI

PEAK-TO-PEAK 0.1Hz TO 1MHz

$T_A = +25^\circ\text{C}$, $A_V = 1000\text{V}\cdot\text{V}$

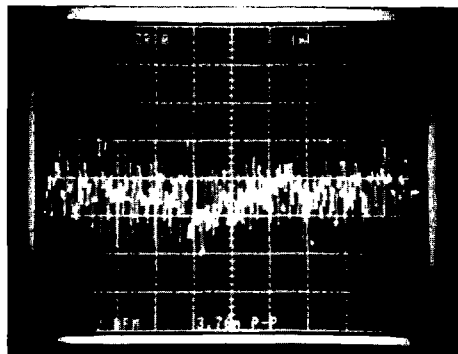

Horizontal Scale: (1sec div)
Vertical Scale: (1mV div)
3.70 μV _{p-p} RTI

FREQUENCY RESPONSE vs. SUPPLY VOLTAGE

$T_A = +25^\circ\text{C}$, $R_L = 10\text{k}$, $C_L = 100\text{pF}$

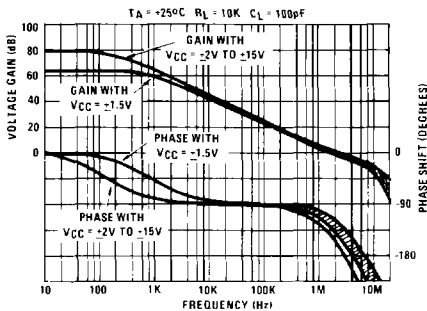

FREQUENCY RESPONSE AT VARIOUS GAINS

$T_A = +25^\circ\text{C}$, $V_{CC} = \pm 15\text{V}$, $R_L = 10\text{k}$, $C_L = 100\text{pF}$

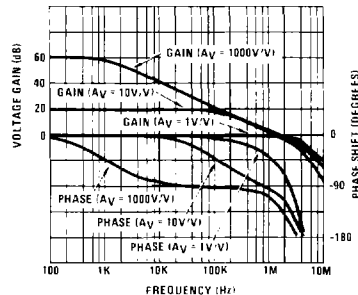

Typical Characteristics (Continued)

OUTPUT VOLTAGE SWING vs. SUPPLY VOLTAGE
(+25°C)

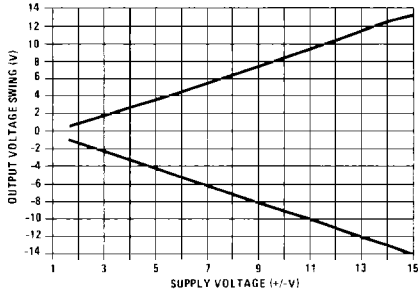

OUTPUT CURRENT vs. SUPPLY VOLTAGE
(+25°C)

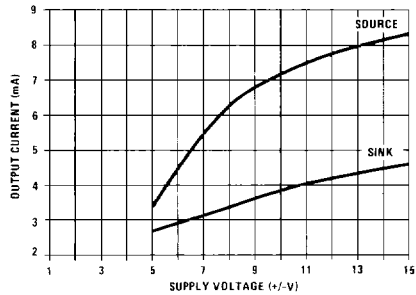

CMMR, PSRR vs. SUPPLY VOLTAGE
(+25°C)

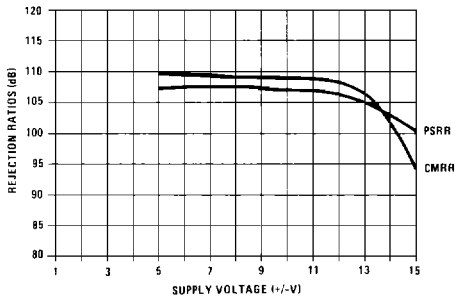

SUPPLY CURRENT vs. SUPPLY VOLTAGE
Per Amplifier (+25°C)

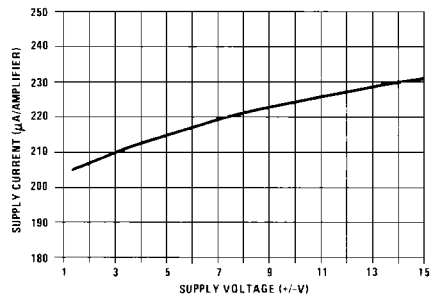

CHANNEL SEPARATION vs. FREQUENCY
 $V_{CC} = \pm 15V, T_A = +25^\circ C$

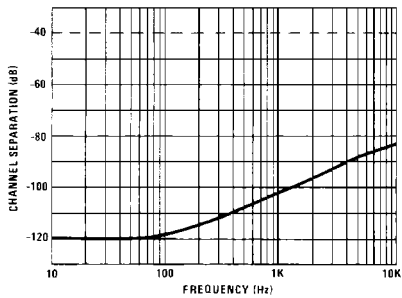

CMRR vs. FREQUENCY
 $T_A = +25^\circ C, V_{CC} = \pm 15V$

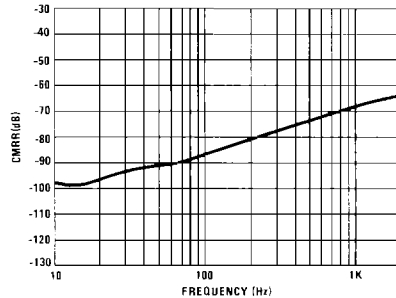

Applications Information

Independent Amplifiers

The HA-5152 dual op amp and the HA-5154 quad op amp consist of completely separate amplifier circuits. Unlike most duals and quads, these devices do not share a common bias network. Thus, one amplifier passing large, or noisy signals will have minimal effect on another channel carrying small, sensitive signals.

Loading

Although the standard load is 10kΩ, the HA-515X is capable of driving resistive loads down to 2kΩ and capacitive loads beyond 300pF.

Input Stage

This amplifier uses a current amplifying input stage (see Application Note 544) and is not recommended for use in applications which involve large differential input voltages such as open-loop comparators. Most op amp

applications use feedback and keep the input terminals at approximately the same voltage. The HA-515X will perform well in these circuits as long as the input terminals see less than 7 volts differential.

Typical Applications

The low power consumption of the HA-5154 makes it ideal for applications like battery-powered instrumentation where the bridge amplifier circuit below would be used.

Choose a low-current zener voltage reference such as LM285Z-2.5 and select R_R accordingly. This circuit was evaluated using the resistor values shown and a laboratory voltage source for the 2.5V reference. With unmatched, off-the-shelf, 1% resistors, a gain accuracy of 1% to 2% can be expected. Temperature testing indicated a voltage offset tempco of less than 100μV/°C referred to output.

$$V_{OUT} = (V_P - V_N) \left[2 \left(1 + \frac{R}{R_G} \right) \right] + V_R$$

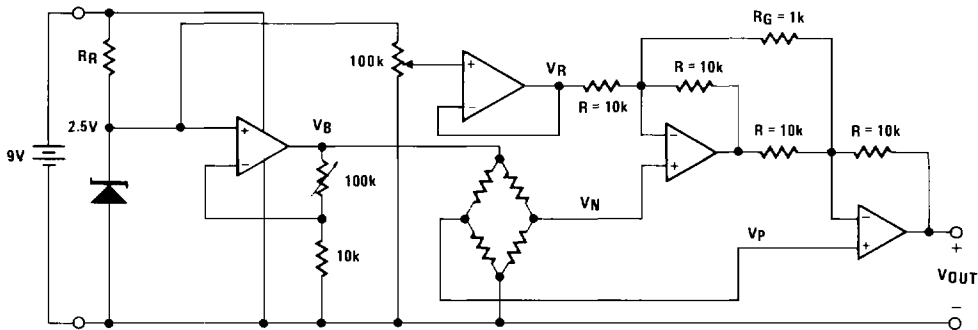

Schematic

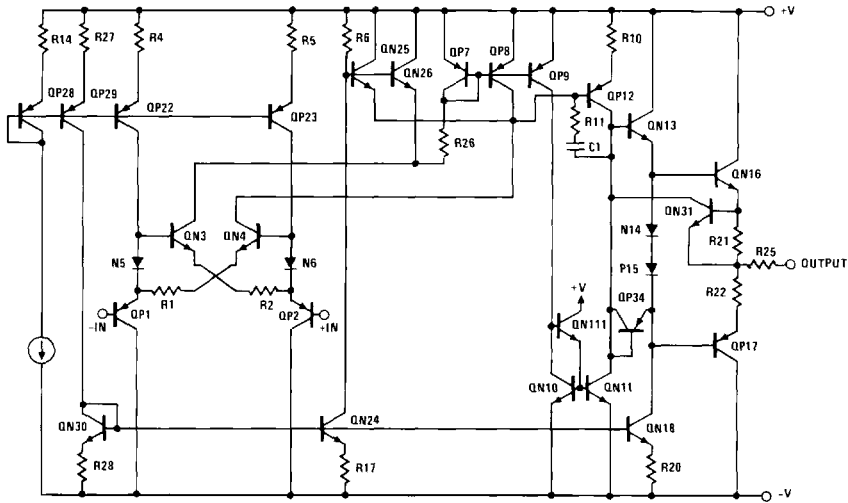

Die Characteristics

Transistor Count		
HA-5151	34
HA-5152	68
HA-5154	136
Substrate Potential*		
Process	Bipolar-DI
Thermal Constants (°C/W)		
	θ_{ja}	θ_{jc}
HA1-5154 (-2, -5, -7)	101	33
HA1-5154 (/883)	75	22
HA2-5151 (-2, -5, -7)	206	56
HA2-5151 (/883)	168	50
HA2-5152 (-2, -5, -7)	184	50
HA2-5152 (/883)	143	43
HA3-5151 (-5)	90	40
HA3-5152 (-5)	80	20
HA3-5154 (-5)	75	20
HA7-5151 (-2, -5, -7)	210	117
HA7-5151 (/883)	90	40
HA7-5152 (-2, -5, -7)	177	92
HA7-5152 (/883)	80	20

*The substrate may be left floating (Insulating Die Mount) or it may be mounted on a conductor at V- potential.

NOTE: Consult Harris for LCC/PLCC information.