



HA-2541

Wideband, Fast Settling, Unity Gain Stable, Operational Amplifier

March 1993

Features

- Unity Gain Bandwidth 40MHz
- High Slew Rate 250V/μs
- Low Offset Voltage 0.8mV
- Fast Settling Time (0.1%) 90ns
- Power Bandwidth 4MHz
- Output Voltage Swing (Min) ±10V
- Unity Gain Stability
- Monolithic Bipolar Dielectric Isolation Construction

Applications

- Pulse and Video Amplifiers
- Wideband Amplifiers
- High Speed Sample-Hold Circuits
- Fast, Precise D/A Converters
- High Speed A/D Input Buffer

For a lower power version of this product, please see the HA-2841 data sheet.

Description

The HA-2541 is the first unity gain stable monolithic operational amplifier to achieve 40MHz unity gain bandwidth. A major addition to the Harris series of high speed, wideband op amps, the HA-2541 is designed for video and pulse applications requiring stable amplifier response at low closed loop gains.

The uniqueness of the HA-2541 is that its slew rate and bandwidth characteristics are specified at unity gain. Historically, high slew rate, wide bandwidth and unity gain stability have been incompatible features for a monolithic operational amplifier. But features such as 250V/μs slew rate and 40MHz unity gain bandwidth clearly show that this is not the case for the HA-2541. These features, along with 90ns settling time to 0.1%, make this product an excellent choice for high speed data acquisition systems.

Mil-Std-883 product and data sheets are available upon request.

For further application suggestions on the HA-2541, please refer to Application Note 550 (Using the HA-2541), and Application Note 556 (Thermal Safe Operating Areas for High Current Operational Amplifiers). Also see 'Applications' in this data sheet.

Ordering Information

PART NUMBER	TEMP. RANGE	PACKAGE
HA1-2541-2	-55°C to +125°C	14 Lead Ceramic DIP
HA1-2541-5	0°C to +75°C	14 Lead Ceramic DIP
HA2-2541-2	-55°C to +125°C	12 Pin Can
HA2-2541-5	0°C to +75°C	12 Pin Can

Pinouts

HA1-2541 (CDIP)
TOP VIEW

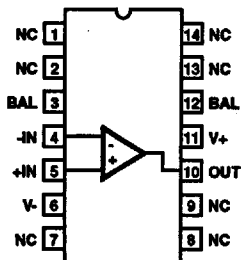

HA2-2541 (TO-8 CAN)
TOP VIEW

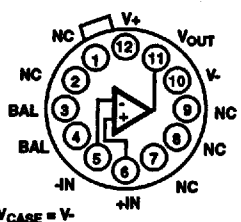

Schematic Diagram

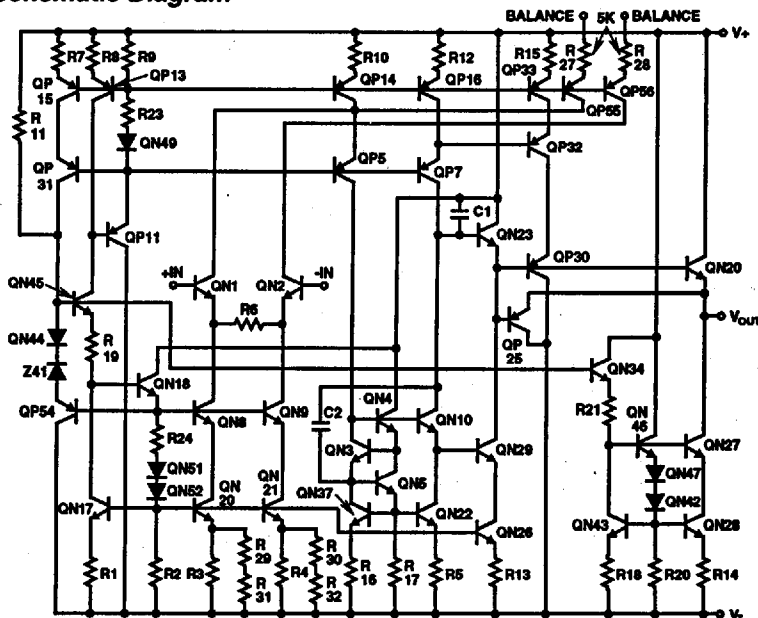

CAUTION: These devices are sensitive to electrostatic discharge. Users should follow proper I.C. Handling Procedures.
Copyright © Harris Corporation 1993

File Number 2898.1

Specifications HA-2541

Absolute Maximum Ratings (Note 1)

Voltage Between V+ and V- Terminals	35V
Differential Input Voltage	6V
Peak Output Current	50mA
Continuous Output Current	28mA _{RMS}
Junction Temperature (Note 11)	+175°C
Lead Temperature (Soldering 10 Sec.)	+300°C

Operating Conditions

Operating Temperature Range	
HA-2541-2	-55°C ≤ T _A ≤ +125°C
HA-2541-5	0°C ≤ T _A ≤ +75°C
Storage Temperature Range	-65°C ≤ T _A ≤ +150°C

CAUTION: Stresses above those listed in "Absolute Maximum Ratings" may cause permanent damage to the device. This is a stress only rating and operation of the device at these or any other conditions above those indicated in the operational sections of this specification is not implied.

Electrical Specifications V_{SUPPLY} = ±15V, R_L = 1kΩ, C_L ≤ 10pF, Unless Otherwise Specified

PARAMETER	TEMP	HA-2541-2 -55°C to +125°C			HA-2541-5 0°C to +75°C			UNITS
		MIN	TYP	MAX	MIN	TYP	MAX	
INPUT CHARACTERISTICS								
Offset Voltage	+25°C	-	0.8	2	-	1	2	mV
	Full	-	-	6	-	-	6	mV
Average Offset Voltage Drift	Full	-	9	-	-	9	-	μV/°C
Bias Current	+25°C	-	11	35	-	11	35	μA
	Full	-	-	50	-	-	50	μA
Average Bias Current Drift	Full	-	85	-	-	85	-	nA/°C
Offset Current	+25°C	-	1	7	-	1	7	μA
	Full	-	-	9	-	-	9	μA
Input Resistance	+25°C	-	100	-	-	100	-	kΩ
Input Capacitance	+25°C	-	1	-	-	1	-	pF
Common Mode Range	Full	±10	±11	-	±10	±11	-	V
Input Noise Voltage (f = 1kHz, R _g = 0Ω)	+25°C	-	10	-	-	10	-	nV/√Hz
Input Noise Current (f = 1kHz, R _g = 0Ω)	+25°C	-	4	-	-	4	-	pA/√Hz
TRANSFER CHARACTERISTICS								
Large Signal Voltage Gain (Note 3)	+25°C	10	16	-	10	16	-	KV/V
	Full	5	-	-	5	-	-	KV/V
Common Mode Rejection Ratio (Note 5)	Full	70	90	-	70	90	-	dB
Minimum Stable Gain	+25°C	1	-	-	1	-	-	V/V
Unity Gain Bandwidth (Note 6)	+25°C	-	40	-	-	40	-	MHz
OUTPUT CHARACTERISTICS								
Output Voltage Swing (Note 4)	Full	±10	±11	-	±10	±11	-	V
Output Current (Note 4)	+25°C	±10	±15	-	±10	±15	-	mA
Output Resistance	+25°C	-	2	-	-	2	-	Ω
Full Power Bandwidth (Note 3 & 7)	+25°C	3	4	-	3	4	-	MHz
Differential Gain (Note 2)	+25°C	-	0.1	-	-	0.1	-	%
Differential Phase (Note 2)	+25°C	-	0.2	-	-	0.2	-	Degrees
Harmonic Distortion (Note 10)	+25°C	-	<0.01	-	-	<0.01	-	%
TRANSIENT RESPONSE (Note 8)								
Rise Time	+25°C	-	4	-	-	4	-	ns
Overshoot	+25°C	-	40	-	-	40	-	%
Slew Rate	+25°C	200	250	-	200	250	-	V/μs

Specifications HA-2541

Electrical Specifications $V_{SUPPLY} = \pm 15V, R_L = 1k\Omega, C_L \leq 10pF$, Unless Otherwise Specified (Continued)

PARAMETER	TEMP	HA-2541-2 -55°C to +125°C			HA-2541-5 0°C to +75°C			UNITS
		MIN	TYP	MAX	MIN	TYP	MAX	
Settling Time								
10V Step to 0.1%	+25°C	-	90	-	-	90	-	ns
10V Step to 0.01%	+25°C	-	175	-	-	175	-	ns
POWER REQUIREMENTS								
Supply Current	+25°C	-	29	-	-	29	-	mA
	Full	-	-	40	-	-	40	mA
Power Supply Rejection Ratio (Note 9)	Full	70	80	-	70	78	-	dB

NOTES:

- Absolute maximum ratings are limiting values, applied individually, beyond which the serviceability of the circuit may be impaired. Functional operability under any of these conditions is not necessarily implied.
- Differential Gain and Phase are measured with a 1V differential voltage at 5MHz.
- $V_O = \pm 10V$
- $R_L = 1k\Omega$
- $V_{CM} = \pm 10V$
- $V_O = 90mV$.
- Full Power Bandwidth guaranteed based on slew rate measurement using $FPBW = \frac{\text{Slew Rate}}{2\pi V_{PEAK}}$
- Refer to Test Circuits section of this data sheet.
- $V_{SUPPLY} = \pm 5VDC$ to $\pm 15VDC$.
- $f = 10kHz; A_V = 5; V_O = 14V_{p,p}$
- This value assumes a no load condition: Maximum power dissipation with load conditions must be designed to maintain the maximum junction temperature below +175°C. By using Application Note 556 on Safe operating Area equations, along with the packaging thermal resistances listed in the Die Characteristics section, proper load conditions can be determined. Heat sinking is recommended above +75°C with suggested models:

14 Lead Ceramic DIP:
Thermalloy #6007 or AAVID #5602B ($\theta_{SA} = 16^\circ C/W$).

12 Lead Metal Can (TO-8):
Thermalloy #2240A ($\theta_{SA} = 27^\circ C/W$) or #2266B ($\theta_{SA} = 24^\circ C/W$).

Die Characteristics

Transistor Count	41	
Die Dimensions	89 x 79 x 19 mils	
Substrate Potential (Power Up)*	V-	
Process	High Frequency Bipolar	
Dielectric Isolation Passivation	SiOx	
Thermal Constants (°C/W)	θ_{JA}	θ_{JC}
Ceramic DIP	71	13
Metal Can	56	29

* The substrate may be left floating (Insulating Die Mount) or it may be mounted on a conductor at V- potential.

Settling Time Circuit

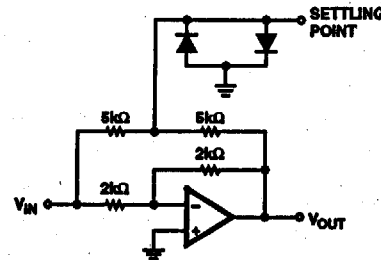

- $A_V = -1$
- Feedback and summing resistor ratios should be 0.1% matched.
- HP5082-2810 clipping diodes recommended.
- Tektronix P6201 FET probe used at settling point.

Test Circuits

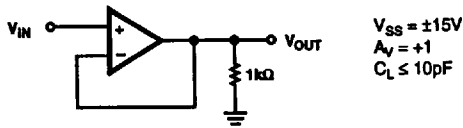
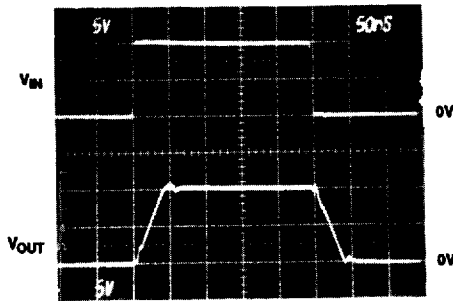
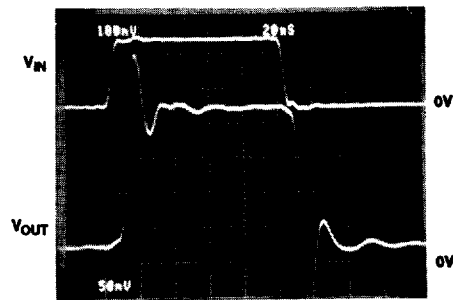

FIGURE 1. TEST CIRCUIT

LARGE SIGNAL RESPONSE
Vertical Scale: (Volts: 5V/Div.)
Horizontal Scale: (Time: 50ns/Div.)



SMALL SIGNAL RESPONSE
Vertical Scale: ($V_{IN} = 100\text{mV/Div.}$, $V_{OUT} = 50\text{mV/Div.}$)
Horizontal Scale: (Time: 20ns/Div.)



PROPAGATION DELAY
Vertical Scale: (Volts: = 100mV/Div.)
Horizontal Scale: (Time: 5ns/Div.)

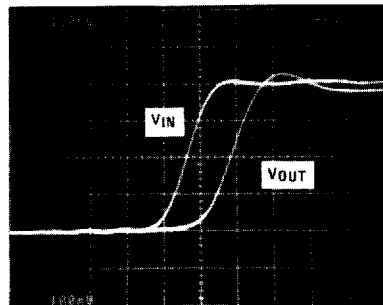

$V_S = \pm 15\text{V}$, $R_L = 1\text{k}\Omega$
 $T = +25^\circ\text{C}$
Propagation delay variance is negligible
over full temperature range.

Typical Performance Curves

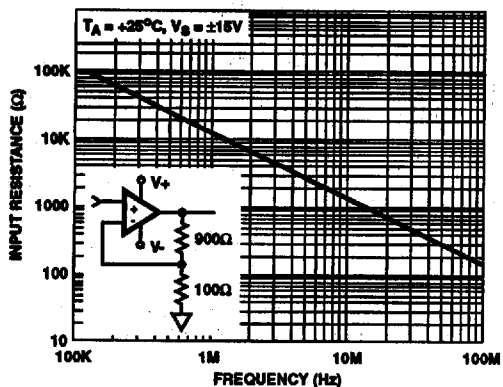

FIGURE 2. INPUT RESISTANCE vs FREQUENCY

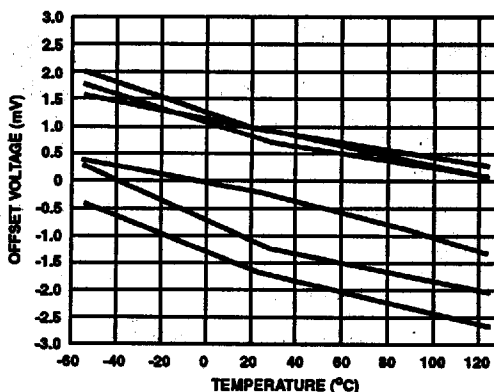

FIGURE 3. OFFSET VOLTAGE DRIFT WITH TEMPERATURE (6 REPRESENTATIVE UNITS)

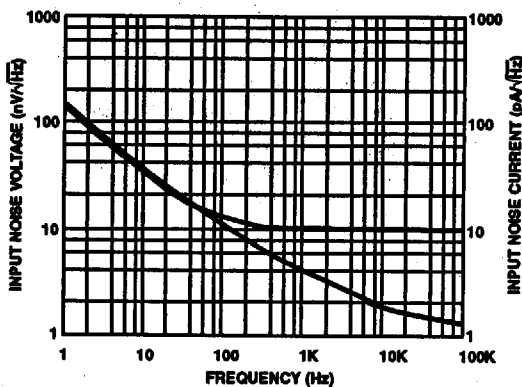

FIGURE 4. NOISE DENSITY vs FREQUENCY ($T_A = +25^\circ\text{C}$)

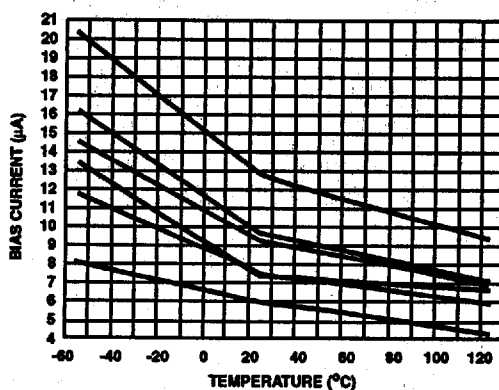

FIGURE 5. BIAS CURRENT DRIFT WITH TEMPERATURE (6 REPRESENTATIVE UNITS)

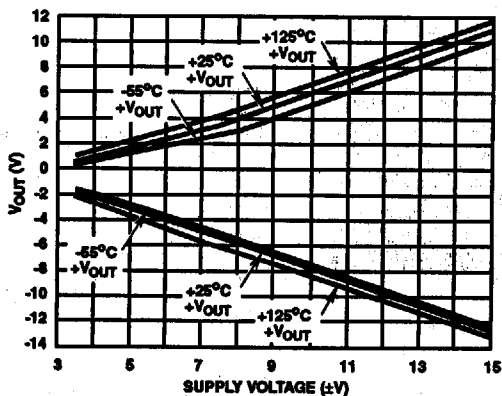

FIGURE 6. OUTPUT VOLTAGE SWING vs SUPPLY VOLTAGE (AT VARIOUS TEMPERATURES)

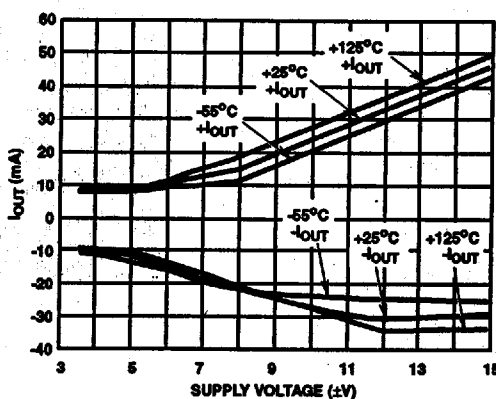

FIGURE 7. OUTPUT CURRENT vs SUPPLY VOLTAGE (AT VARIOUS TEMPERATURES)

Typical Performance Curves (Continued)

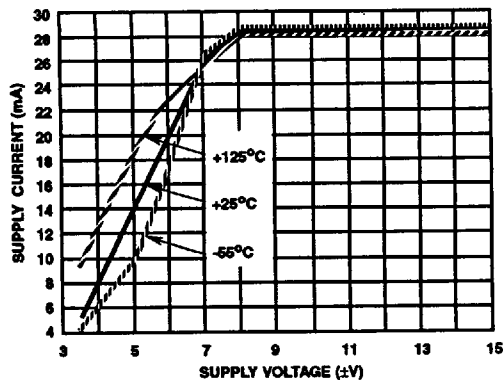

FIGURE 8. SUPPLY CURRENT vs SUPPLY VOLTAGE (AT VARIOUS TEMPERATURES)

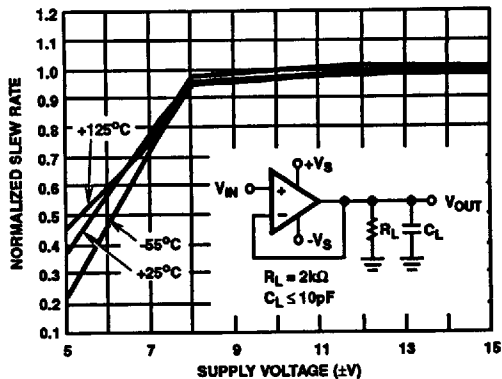

FIGURE 9. SLEW RATE vs SUPPLY VOLTAGE (NORMALIZED WITH $V_S = \pm 15V$ AT $+25^\circ C$)

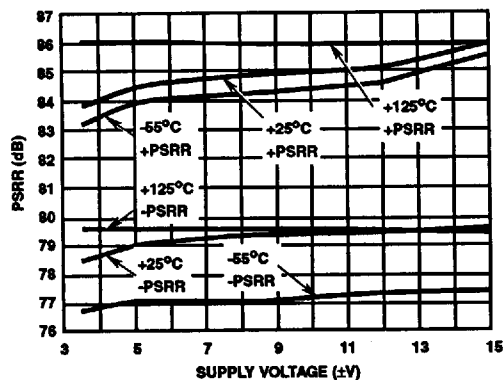

FIGURE 10. PSRR vs SUPPLY VOLTAGE (AVERAGE OF 3 LOTS AT VARIOUS TEMPERATURES)

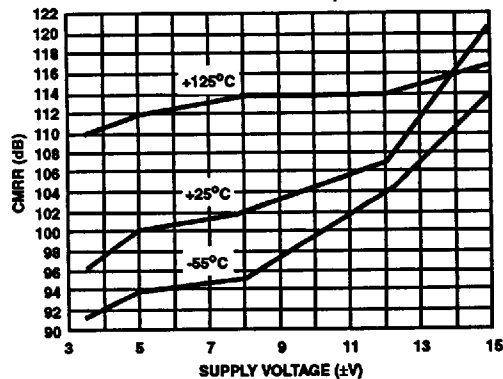

FIGURE 11. CMRR vs SUPPLY VOLTAGE (AVERAGE OF 3 LOTS AT VARIOUS TEMPERATURES)

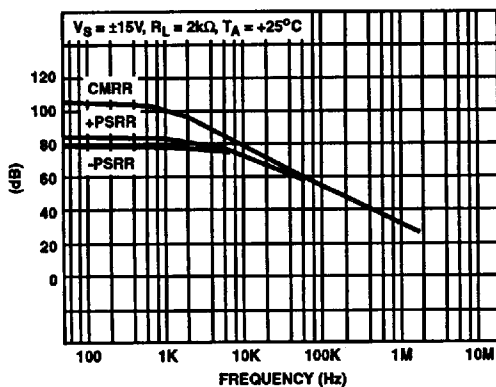

FIGURE 12. REJECTION RATIOS vs FREQUENCY

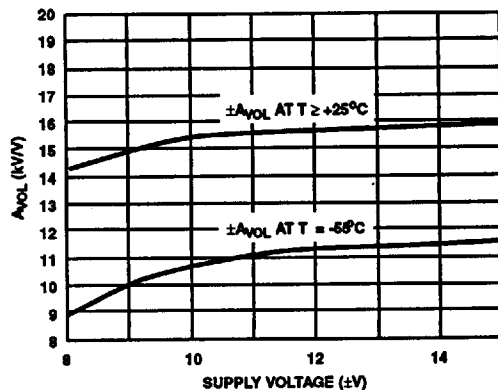
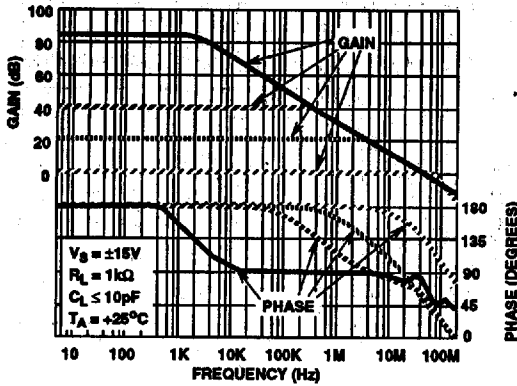

FIGURE 13. \pm OPEN LOOP GAIN vs SUPPLY VOLTAGE (AVERAGE OF 3 LOTS OVER TEMPERATURE)

2
OPERATIONAL AMPLIFIERS

HA-2541

Typical Performance Curves (Continued)



OPEN LOOP ——— $A_V = -100$ - - - - - $A_V = -10$ ······ $A_V = -1$ / / / / /

FIGURE 14. GAIN AND PHASE FREQUENCY RESPONSE

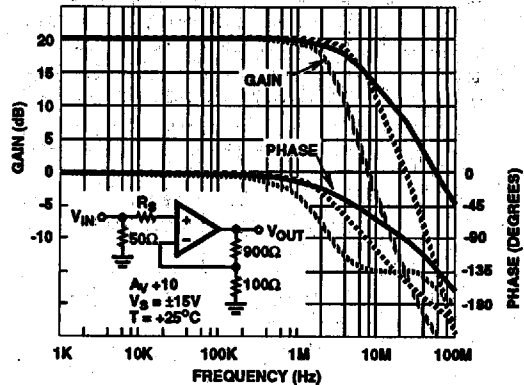

$R_S = 0\Omega$ ——— $R_S = 5k\Omega$ - - - - - $R_S = 50k\Omega$ ······

FIGURE 15. SMALL SIGNAL BANDWIDTH vs SOURCE RESISTANCE ($V_S = \pm 15V$, $R_L = 1k\Omega$)

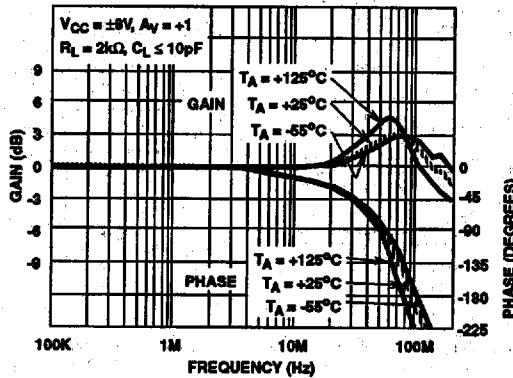
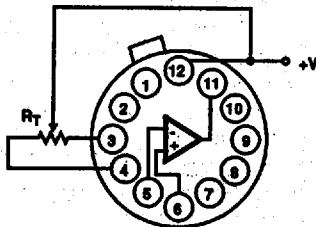

FIGURE 16. CLOSED LOOP FREQUENCY RESPONSE vs TEMPERATURE

Suggested Offset Voltage Adjustment



Tested Offset Adjustment Range is $IV_{OS} + 1mV$ minimum referred to output. Typical range is $\pm 15mV$ for $R_T = 5k\Omega$.

Applications (Also see Application Note 550)

Application 1

High power amplifiers and buffers are in use in a wide variety of applications. Many times the "high power" capability is needed to drive large capacitive loads as well as low value resistive loads. In both cases the final driver stage is usually a power transistor of some type, but because of their inherently low gain, several stages of pre-drivers are often required. The HA-2541, with its 10mA output rating, is powerful enough to drive a power transistor without additional stages of current amplification. This capability is well demonstrated with the high power buffer circuit in Figure 17.

The HA-2541 acts as the pre-driver to the output power transistor. Together, they form a unity gain buffer with the ability to drive three 50Ω coaxial cables in parallel, each with a capacitance of 2000pF. The total combined load is 16.6Ω and 6000pF capacitance.

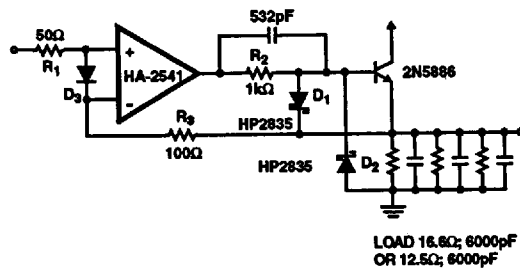

FIGURE 17. DRIVING POWER TRANSISTORS TO GAIN ADDITIONAL CURRENT BOOSTING

Application 2

Video

One of the primary uses of the HA-2541 is in the area of video applications. These applications include signal construction, synchronization addition and removal, as well as signal modification. A wide bandwidth device such as the HA-2541 is well suited for use in this class of amplifier. This, however, is a more involved group of applications than ordinary amplifier applications since video signals contain precise DC levels which must be retained.

The addition of a clamping circuit restores DC levels at the output of an amplifier stage. The circuit shown in Figure 18 utilizes the HA-5320 sample and hold amplifier as the DC clamp. Also shown is a 3.57MHz trap in series, which will block the color burst portion of the video signal and allow the DC level to be amplified and restored.

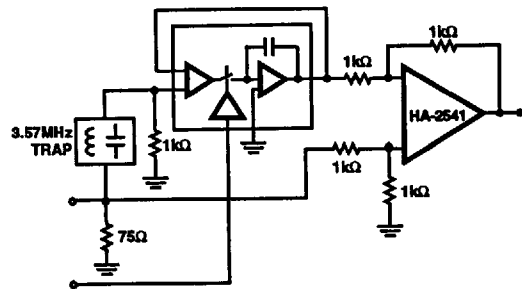

FIGURE 18. VIDEO DC RESTORER

2
OPERATIONAL
AMPLIFIERS