

Ultra-Low Noise Precision Wideband Operational Amplifier

March 1993

Features

- High Speed 20V/ μ s
- Wide Gain Bandwidth ($A_v \geq 5$) 63MHz
- Low Noise 3nV/ $\sqrt{\text{Hz}}$ at 1kHz
- Low V_{OS} 10 μ V
- High CMRR 126dB
- High Gain 1800V/mV

Applications

- High Speed Signal Conditioners
- Wide Bandwidth Instrumentation Amplifiers
- Low Level Transducer Amplifiers
- Fast, Low Level Voltage Comparators
- Highest Quality Audio Preamplifiers
- Pulse/RF Amplifiers
- For Further Design Ideas See Application Note 553

Ordering Information

PART NUMBER	TEMPERATURE RANGE	PACKAGE
HA2-5137-2	-55°C to +125°C	8 Pin Can
HA2-5137-5	0°C to +75°C	8 Pin Can
HA2-5137A-2	-55°C to +125°C	8 Pin Can
HA2-5137A-5	0°C to +75°C	8 Pin Can
HA3-5137-5	0°C to +75°C	8 Lead Plastic DIP
HA3-5137A-5	0°C to +75°C	8 Lead Plastic DIP
HA7-5137-2	-55°C to +125°C	8 Lead Ceramic DIP
HA7-5137-5	0°C to +75°C	8 Lead Ceramic DIP
HA7-5137A-2	-55°C to +125°C	8 Lead Ceramic DIP
HA7-5137A-5	0°C to +75°C	8 Lead Ceramic DIP
HA9P5137-5	0°C to +75°C	8 Lead SOIC

Description

The HA-5137 monolithic operational amplifier features an unparalleled combination of precision DC and wideband high speed characteristics. Utilizing the Harris Dielectric Isolation technology and advanced processing techniques, this unique design unites low noise (3nV/ $\sqrt{\text{Hz}}$) precision instrumentation performance with high speed (20V/ μ s) wide-band capability.

This amplifier's impressive list of features include low V_{OS} (10 μ V), wide gain bandwidth (63MHz), high open loop gain (1800V/mV), and high CMRR (126dB). Additionally, this flexible device operates over a wide supply range ($\pm 5V$ to $\pm 20V$) while consuming only 140mW of power.

Using the HA-5137 allows designers to minimize errors while maximizing speed and bandwidth in applications requiring gains greater than five.

This device is ideally suited for low level transducer signal amplifier circuits. Other applications which can utilize the HA-5137's qualities include instrumentation amplifiers, pulse or RF amplifiers, audio preamplifiers, and signal conditioning circuits.

This device can easily be used as a design enhancement by directly replacing the 725, OP25, OP06, OP07, OP27 and OP37 where gains are greater than five. For the military grade product, refer to the HA-5137/883 data sheet.

2
OPERATIONAL
AMPLIFIERS

Pinouts

HA-5137 (TO-99 METAL CAN)
TOP VIEW

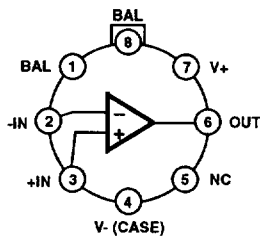

HA-5137 (PDIP, CDIP, SOIC)
TOP VIEW

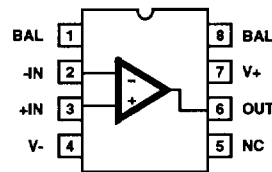

CAUTION: These devices are sensitive to electrostatic discharge. Users should follow proper I.C. Handling Procedures.
Copyright © Harris Corporation 1993

2-525

File Number 2908.1

Specifications HA-5137, HA-5137A

Absolute Maximum Ratings

$T_A = +25^\circ\text{C}$ Unless Otherwise Specified
 Voltage Between V_+ and V_- Terminals 44V
 Differential Input Voltage (Note 1) 0.7V
 Output Current Full Short Circuit Protection
 Junction Temperature (Note 12) $+175^\circ\text{C}$
 Junction Temperature (Plastic Packages) $+150^\circ\text{C}$
 Lead Temperature (Soldering 10s) $+300^\circ\text{C}$

Operating Temperature Ranges

HA-5137/37A-2 $-55^\circ\text{C} \leq T_A \leq +125^\circ\text{C}$
 HA-5137/37A-5 $0^\circ\text{C} \leq T_A \leq +75^\circ\text{C}$
 Storage Temperature Range $-65^\circ\text{C} \leq T_A \leq +150^\circ\text{C}$

CAUTION: Stresses above those listed in "Absolute Maximum Ratings" may cause permanent damage to the device. This is a stress only rating and operation of the device at these or any other conditions above those indicated in the operational sections of this specification is not implied.

Electrical Specifications $V_+ = +15\text{V}$, $V_- = -15\text{V}$, $C_L \leq 50\text{pF}$, $R_S \leq 100\Omega$

PARAMETER	TEMP	HA-5137A			HA-5137			UNITS	
		MIN	TYP	MAX	MIN	TYP	MAX		
INPUT CHARACTERISTICS									
Offset Voltage	$+25^\circ\text{C}$	-	10	25	-	30	100	μV	
	Full	-	30	60	-	70	300	μV	
Average Offset Voltage Drift	Full	-	0.2	0.6	-	0.4	1.8	$\mu\text{V}/^\circ\text{C}$	
Bias Current	$+25^\circ\text{C}$	-	10	40	-	15	80	nA	
	Full	-	20	60	-	35	150	nA	
Offset Current	$+25^\circ\text{C}$	-	7	35	-	12	75	nA	
	Full	-	15	50	-	30	135	nA	
Common Mode Range	Full	± 10.3	± 11.5	-	± 10.3	± 11.5	-	V	
Differential Input Resistance (Note 2)	$+25^\circ\text{C}$	1.5	6	-	0.8	4	-	M Ω	
Input Noise Voltage 0.1Hz to 10Hz (Note 3)	$+25^\circ\text{C}$	-	0.08	0.18	-	0.09	0.25	$\mu\text{V}_{\text{p-p}}$	
Input Noise Voltage Density (Note 4)	f = 10Hz	$+25^\circ\text{C}$	-	3.5	5.5	-	3.8	8.0	$\text{nV}/\sqrt{\text{Hz}}$
	f = 100Hz	$+25^\circ\text{C}$	-	3.1	4.5	-	3.3	5.6	$\text{nV}/\sqrt{\text{Hz}}$
	f = 1000Hz	$+25^\circ\text{C}$	-	3.0	3.8	-	3.2	4.5	$\text{nV}/\sqrt{\text{Hz}}$
Input Noise Current Density (Note 4)	f = 10Hz	$+25^\circ\text{C}$	-	1.7	4.0	-	1.7	-	$\text{pA}/\sqrt{\text{Hz}}$
	f = 100Hz	$+25^\circ\text{C}$	-	1.0	2.3	-	1.0	-	$\text{pA}/\sqrt{\text{Hz}}$
	f = 1000Hz	$+25^\circ\text{C}$	-	0.4	0.6	-	0.4	0.6	$\text{pA}/\sqrt{\text{Hz}}$
TRANSFER CHARACTERISTICS									
Large Signal Voltage Gain (Note 5)	$+25^\circ\text{C}$	1000	1800	-	700	1500	-	V/mV	
	Full	600	1200	-	300	800	-	V/mV	
Common Mode Rejection Ratio (Note 6)	Full	114	126	-	100	120	-	dB	
Minimum Stable Gain	$+25^\circ\text{C}$	5	-	-	5	-	-	V/V	
Gain-Bandwidth-Product	f = 10kHz	$+25^\circ\text{C}$	60	80	-	60	80	-	MHz
	f = 1MHz	$+25^\circ\text{C}$	-	63	-	-	63	-	MHz
OUTPUT CHARACTERISTICS									
Output Voltage Swing	$R_L = 600\Omega$	$+25^\circ\text{C}$	± 10.0	± 11.5	-	± 10.0	± 11.5	-	V
	$R_L = 2\text{k}\Omega$	Full	± 11.7	± 13.8	-	± 11.4	± 13.5	-	V
Full Power Bandwidth (Note 7)	$+25^\circ\text{C}$	220	320	-	220	320	-	kHz	
Output Resistance, Open Loop	$+25^\circ\text{C}$	-	70	-	-	70	-	Ω	
Output Current	$+25^\circ\text{C}$	16.5	25	-	16.5	25	-	mA	

Specifications HA-5137, HA-5137A

Electrical Specifications $V_+ = +15V$, $V_- = -15V$, $C_L \leq 50pF$, $R_S \leq 100\Omega$ (Continued)

PARAMETER	TEMP	HA-5137A			HA-5137			UNITS
		MIN	TYP	MAX	MIN	TYP	MAX	
TRANSIENT RESPONSE (Note 8)								
Rise Time	+25°C	-	-	100	-	-	100	ns
Slew Rate (Note 10)	+25°C	14	20	-	14	20	-	V/ μ s
Settling Time (Note 9)	+25°C	-	1.0	-	-	1.0	-	μ s
Overshoot	+25°C	-	20	40	-	20	40	%
POWER SUPPLY CHARACTERISTICS								
Supply Current	+25°C	-	3.5	-	-	3.5	-	mA
	Full	-	-	4.0	-	-	4.0	mA
Power Supply Rejection Ratio (Note 11)	Full	-	2	4	-	16	51	μ V/V

NOTES:

1. For differential input voltages greater than 0.7V, the input current must be limited to 25mA to protect the back-to-back input diodes.
2. This parameter value is based upon design calculations.
3. Refer to Typical Performance section of the data sheet.
4. The limits for this parameter are based on lab characterization, and reflect lot-to-lot variation.
5. $V_{OUT} = \pm 10V$, $R_L = 2k\Omega$
6. $V_{CM} = \pm 10V$
7. Full power bandwidth guaranteed based on slew rate measurement using: $FPBW = \frac{\text{Slew Rate}}{2\pi V_{PEAK}}$
8. Refer to Test Circuits section of the data sheet.
9. Settling time is specified to 0.1% of final value for a 10V output step and $A_v = -5$.
10. $V_{OUT} = \pm 3V$ (6V Step).
11. $V_S = \pm 4V$ to $\pm 18V$
12. See Thermal Constants in "Die Characteristics" text.

Die Characteristics

Transistor Count	63	Thermal Constants (°C/W)	θ_{JA}	θ_{JC}
Die Dimensions	65 x 104.3 x 19 mils (1700 μ m x 2600 μ m x 480 μ m)	Ceramic Mini-DIP	114	34
Substrate Potential*	V-	TO-99 Metal Can	108	33
Process	Bipolar-DI	Plastic DIP	92	30
		SOIC	157	43

* The substrate may be left floating (insulating Die Mount) or it may be mounted on a conductor at V- potential.

Schematic

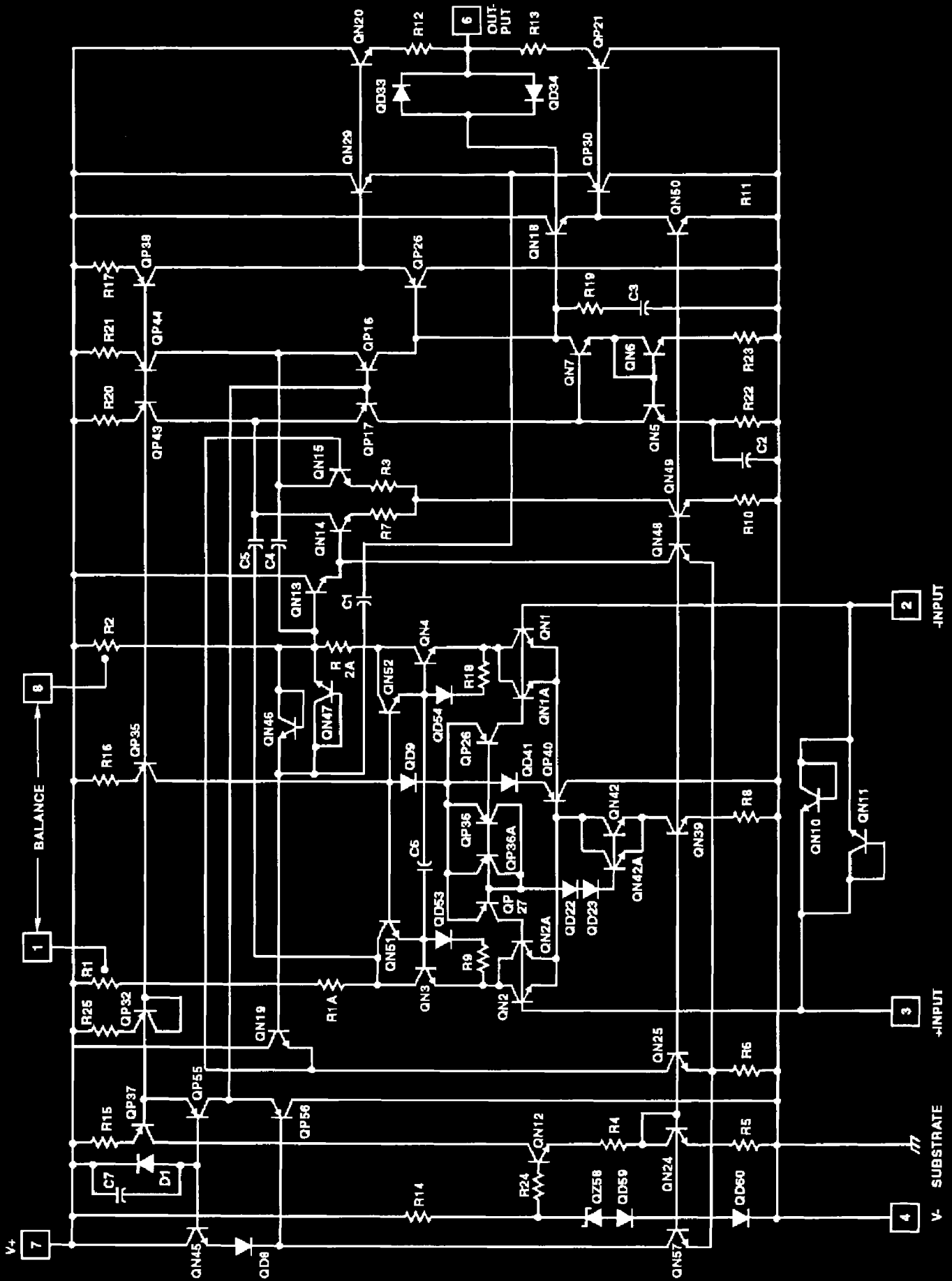

Test Circuits

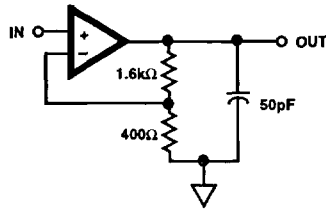
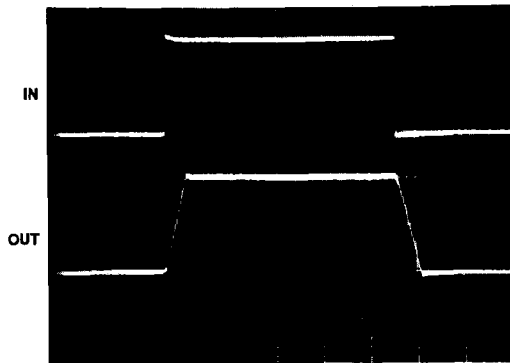

FIGURE 1. LARGE AND SMALL SIGNAL RESPONSE TEST CIRCUIT

LARGE SIGNAL RESPONSE

Vertical Scale: (Volts: Input = 1V/Div.)
 (Volts: Output = 5V/Div.)
 Horizontal Scale: (Time = 1μs/Div.)



SMALL SIGNAL RESPONSE

Vertical Scale: (Volts: Input = 20mV/Div.)
 (Volts: Output = 100mV/Div.)
 Horizontal Scale: (Time = 100ns/Div.)

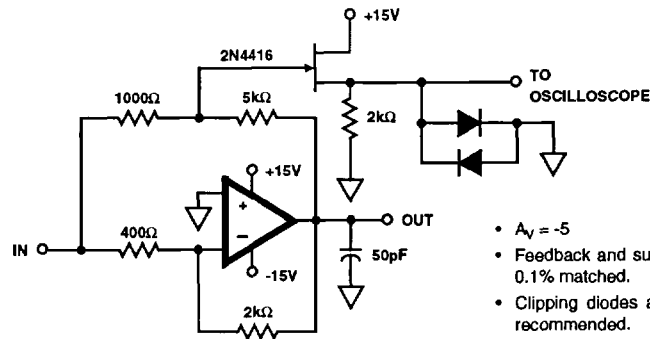
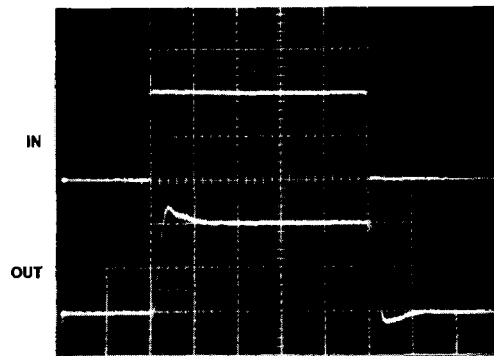

- $A_v = -5$
- Feedback and summing resistors should be 0.1% matched.
- Clipping diodes are optional. HP5082-2810 recommended.

FIGURE 2. SETTLING TIME TEST CIRCUIT

Typical Performance Curves Unless Otherwise Specified: $T_A = +25^\circ\text{C}$, $V_{\text{SUPPLY}} = \pm 15\text{V}$

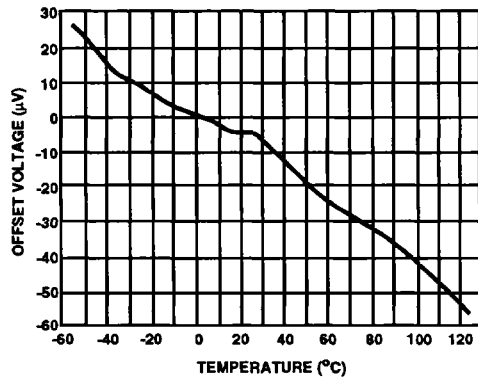

FIGURE 3. TYPICAL OFFSET VOLTAGE DRIFT vs TEMPERATURE

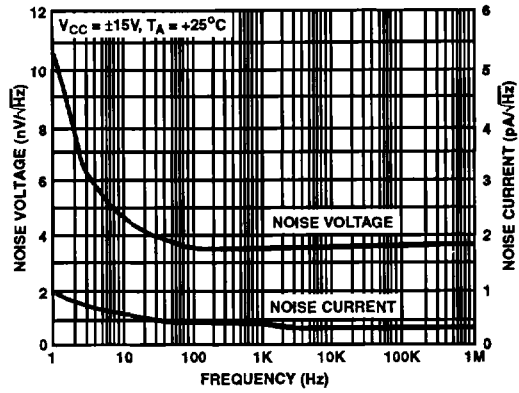

FIGURE 4. NOISE CHARACTERISTICS

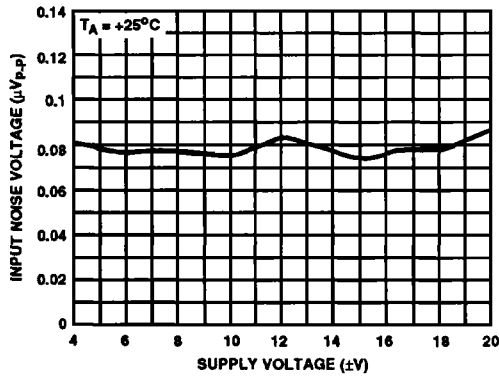

FIGURE 5. NOISE vs SUPPLY VOLTAGE

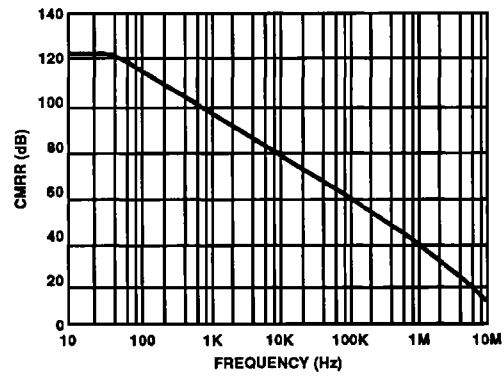

FIGURE 6. CMRR vs FREQUENCY

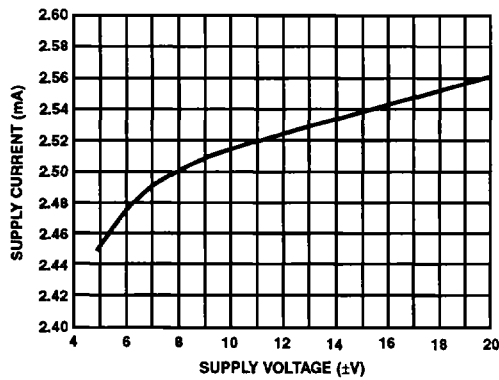

FIGURE 7. SUPPLY CURRENT vs SUPPLY VOLTAGE

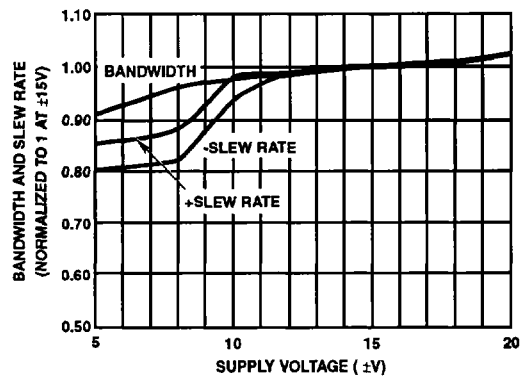

FIGURE 8. BANDWIDTH AND SLEW RATE vs SUPPLY VOLTAGE

Typical Performance Curves Unless Otherwise Specified: $T_A = +25^\circ\text{C}$, $V_{\text{SUPPLY}} = \pm 15\text{V}$ (Continued)

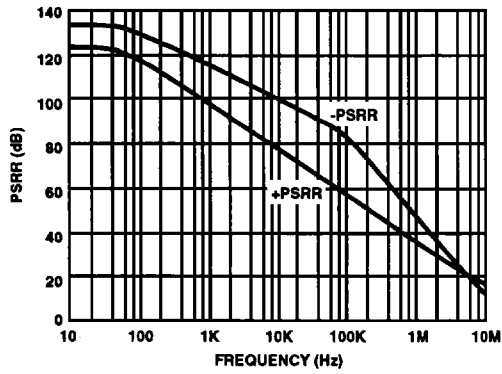

FIGURE 9. PSRR vs FREQUENCY

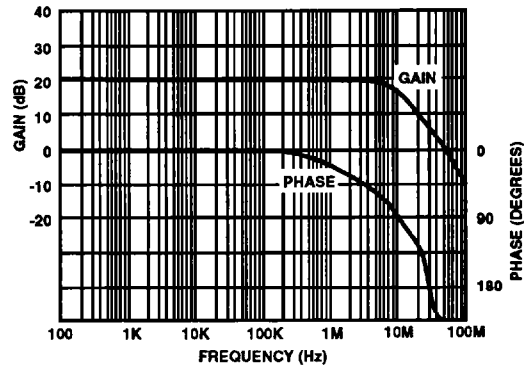

FIGURE 10. CLOSED LOOP GAIN AND PHASE vs FREQUENCY

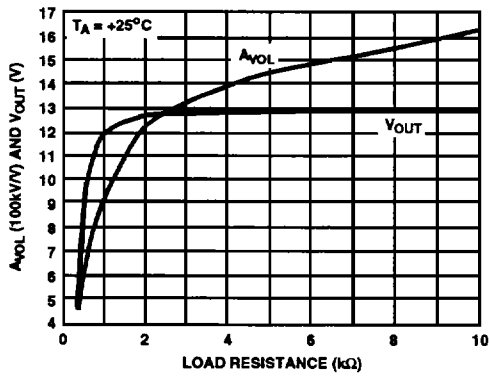

FIGURE 11. A_{VOL} AND V_{OUT} vs LOAD RESISTANCE

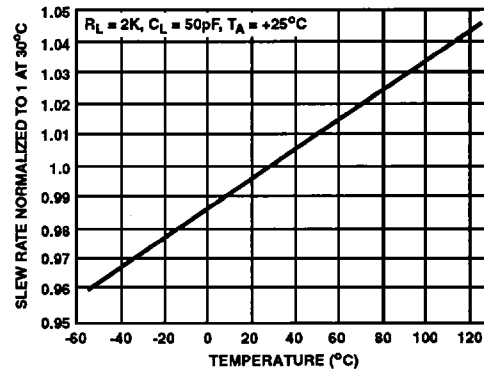

FIGURE 12. NORMALIZED SLEW RATE vs TEMPERATURE

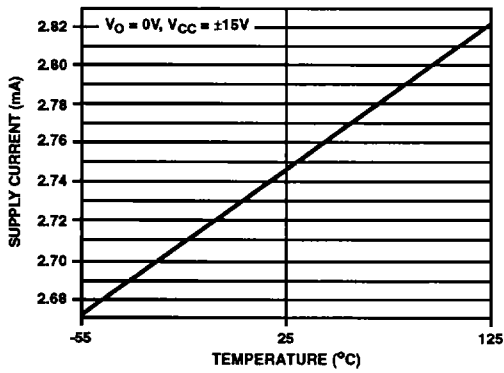

FIGURE 13. SUPPLY CURRENT vs TEMPERATURE

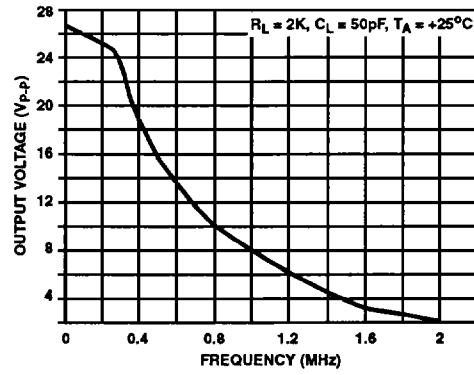

FIGURE 14. $V_{\text{OUT MAX}}$ (UNDISTORTED SINEWAVE OUTPUT) vs FREQUENCY

Typical Performance Curves Unless Otherwise Specified: $T_A = +25^\circ\text{C}$, $V_{\text{SUPPLY}} = \pm 15\text{V}$ (Continued)

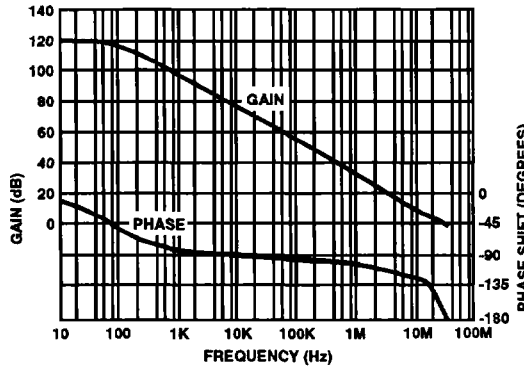

FIGURE 15. OPEN LOOP GAIN AND PHASE vs. FREQUENCY

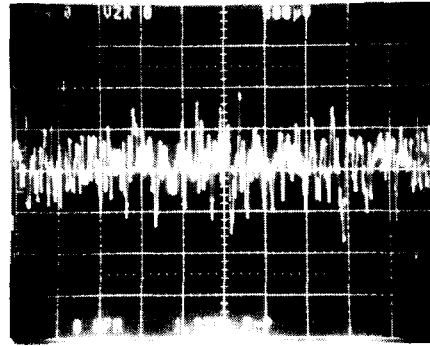

FIGURE 16. PEAK-TO-PEAK NOISE VOLTAGE (0.1Hz TO 10Hz)

$A_{\text{CL}} = 25,000\text{V/V}$
 Horizontal Scale = 1sec/Div.
 Vertical Scale = 0.002 $\mu\text{V/Div.}$
 $E_N = 0.08\mu\text{V}_{\text{p.p. RTI}}$

Application Information

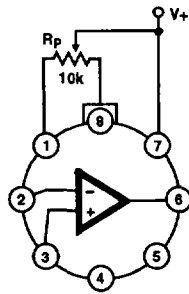
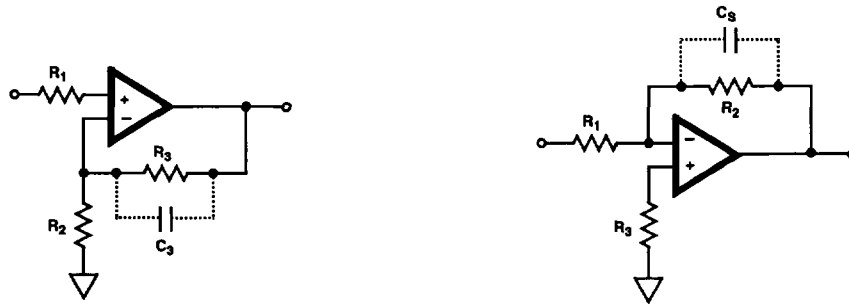

FIGURE 17. SUGGESTED OFFSET VOLTAGE ADJUSTMENT

Test Offset Adjustment Range is $IV_{\text{OS}} + 1\text{mV}$ minimum referred to output. Typical range is $\pm 4\text{mV}$ with $R_p = 10\text{k}\Omega$



Low resistances are preferred for low noise applications as a $1\text{k}\Omega$ resistor has $4\text{nV}/\sqrt{\text{Hz}}$ of thermal noise. Total resistances of greater than $10\text{k}\Omega$ on either input can reduce stability. In most high resistance applications, a few picofarads of capacitance across the feedback resistor will improve stability.

FIGURE 18. SUGGESTED STABILITY CIRCUITS