

## Single/Dual/Quad Ultra-Low Power Operational Amplifiers

### Features

- Low Supply Current.....45 $\mu$ A/Amp
- Wide Supply Voltage Range ..... Single 3V to 30V  
or Dual  $\pm 1.5V$  to  $\pm 15V$
- High Slew Rate ..... 1.5V/ $\mu$ s
- High Gain ..... 100kV/V
- Unity Gain Stable
- Available in Singles, Duals and Quads

### Applications

- Portable Instruments
- Meter Amplifiers
- Telephone Headsets
- Microphone Amplifiers
- Instrumentation
- For Further Design Ideas See App. Note 544

### Description

The HA-5141/42/44 ultra-low power operational amplifiers provided AC and DC performance characteristics similar to or better than most general purpose amplifiers while only drawing 1/30 of the supply current of most general purpose amplifiers. In applications which require low power dissipation and good A.C. electrical characteristics, this family offers the industry's best speed/power ratio.

The HA-5141/42/44 provides accurate signal processing by virtue of their low input offset voltage (0.5mV), low input bias current (45nA), high open loop gain (100kV/V) and low noise, for low power operational amplifiers (20nV/ $\sqrt{\text{Hz}}$ ). These characteristics coupled with a 1.5/ $\mu$ s slew rate and a 400kHz bandwidth make the HA-5141/42/44 ideal for use

in low power instrumentation, audio amplifier and active filter designs. The wide range of supply voltages (3V to 30V) also allow these amplifiers to be very useful in low voltage battery powered equipment. These parts are also tested and guaranteed at both  $\pm 15V$  and single ended +5V supplies.

These amplifiers are available in singles (HA-5141, Can or Mini-DIP), duals (HA-5142, Can, Mini-DIP or 20 pin LCC) or quads (HA-5144, 14 pin DIP or 20 pin LCC) with industry standards pinouts which allow the HA-5141/5142/5144's to be interchangeable with most other operational amplifiers. For military grade product refer to the 5141, 5142, 5144/883 data sheet.

### Pinouts

HA1-5141 (CERAMIC MINI-DIP)  
HA3-5141 (PLASTIC MINI-DIP)

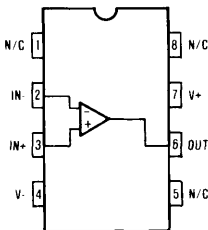

HA2-5141 (TO-99 METAL CAN)

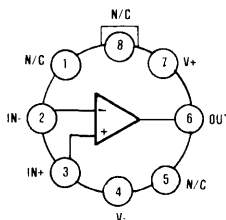

### TOP VIEWS

HA3-5142 (PLASTIC MINI-DIP)  
HA7-5142 (CERAMIC MINI-DIP)

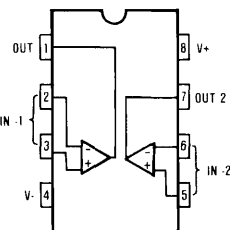

HA2-5142 (TO-99 METAL CAN)

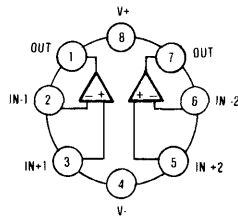

HA1-5144 (CERAMIC DIP)  
HA3-5144 (PLASTIC DIP)

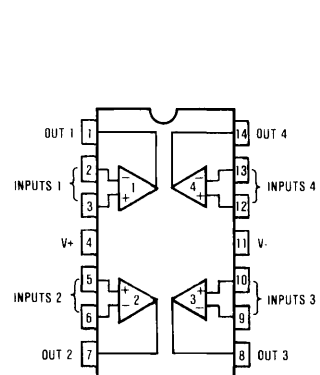

## Specifications HA-5141/42/44

### Absolute Maximum Ratings (Note 1)

Voltage Between V+ and V- Terminals..... 35V  
 Differential Input Voltage.....  $\pm 7V$   
 Output Current..... S/C Protected  
 Internal Power Dissipation..... 500mW

### Operating Temperature Range

HA-5141/42/44-5 .....  $0^{\circ}C \leq T_A \leq +75^{\circ}C$   
 HA-5141/42/44-2 .....  $-55^{\circ}C \leq T_A \leq +125^{\circ}C$   
 Storage Temperature Range .....  $-65^{\circ}C \leq T_A \leq +150^{\circ}C$

### Electrical Specifications $R_S = 100\Omega$ , $C_L \leq 10pF$ Unless Otherwise Specified.

PARAMETER	TEMP	V+ = +5V, V- = 0V			V+ = +15V, V- = -15V			UNITS
		MIN	TYP	MAX	MIN	TYP	MAX	
<b>INPUT CHARACTERISTICS</b>								
Offset Voltage (Note 11)	+25°C		2	6		2	6	mV
	Full			8			8	mV
Average Offset Voltage Drift	Full		3			3		$\mu V/^{\circ}C$
Bias Current (Note 11)	+25°C		45	100		45	100	nA
	Full			125			125	nA
Offset Current (Note 11)	+25°C		0.3	10		0.3	10	nA
	Full			20			20	nA
Common Mode Range	Full	0 to 3			$\pm 10$			V
Differential Input Resistance	+25°C		0.6			0.6		M $\Omega$
Input Noise Voltage (f = 1kHz)	+25°C		20			20		$nV/\sqrt{Hz}$
Input Noise Current (f = 1kHz)	+25°C		0.25			0.25		$pA/\sqrt{Hz}$
<b>TRANSFER CHARACTERISTICS</b>								
Large Signal Voltage Gain (Notes 2, 4)	+25°C	20k	100k		20k	100k		V/V
	Full	15k			15k			V/V
Common Mode Rejection Ratio (Note 7)	Full	77	105		77	105		dB
Bandwidth (Notes 2, 3)	+25°C		0.4			0.4		MHz
<b>OUTPUT CHARACTERISTICS</b>								
Output Voltage Swing (Notes 2, 10)	+25°C	1.0 to 3.8	0.7 to 4.2		$\pm 10$	$\pm 13$		V
	Full	1.2 to 3.5	0.9 to 4.0		$\pm 10$	$\pm 13$		V
Full Power Bandwidth (Notes 2, 4, 8)	+25°C		240			24		kHz
<b>TRANSIENT RESPONSE (Notes 2, 3)</b>								
Rise Time	+25°C		600			600		ns
Slew Rate (Note 6)	+25°C	0.8	1.5		0.8	1.5		V/ $\mu s$
Settling Time (Note 5)	+25°C		10			10		$\mu s$
<b>POWER SUPPLY CHARACTERISTICS</b>								
Supply Current	+25°C		45	80		100	150	$\mu A/Amp$
	Full			100			200	$\mu A/Amp$
Power Supply Rejection Ratio (Note 9)	Full	77	105		77	105		dB

#### NOTES:

- Absolute maximum ratings are limiting values, applied individually beyond which the serviceability of the circuit may be impaired. Functional operability under any of these conditions is not necessarily implied.
- $R_L = 50k\Omega$
- $C_L = 50pF$
- $V_O = 1.4$  to  $2.5V$  for  $V_{CC} = +5, 0V$ ;  $V_O = \pm 10V$  for  $V_{CC} = \pm 15V$ .
- Settling Time is specified to 0.1% of final value for a 3V output step and  $\Delta V = -1$  for  $V_{CC} = +5V, 0V$ . Output step =  $10V$  for  $V_{CC} = \pm 15V$ .
- Maximum input slew rate =  $10V/\mu s$ .
- $V_{CM} = 0$  to  $3V$  for  $V_{CC} = +5, 0V$ ;  $V_{CM} = \pm 10V$  for  $V_{CC} = \pm 15V$
- Full Power Bandwidth is guaranteed by equation:  

$$\text{Full Power Bandwidth} = \frac{\text{Slew Rate}}{2\pi V_{\text{Peak}}}$$
- $\Delta V_S = +10V$  for  $V_{CC} = +5, 0V$ ;  $\Delta V_S = \pm 5V$  for  $V_{CC} = \pm 15V$ .
- For  $V_{CC} = +5, 0V$  terminate  $R_L$  at  $+2.5V$ . Typical output current is  $\pm 3mA$ .
- $V_O = 1.4V$  for  $V_{CC} = +5V, 0V$ .

**Test Circuits**

**SLEW RATE AND TRANSIENT RESPONSE TEST CIRCUIT**

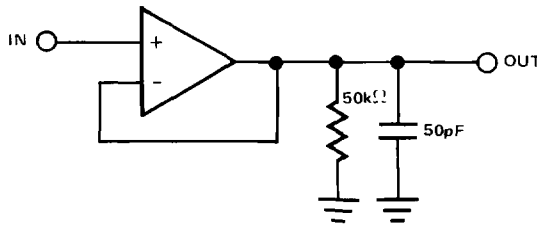

**LARGE SIGNAL RESPONSE**

Vertical Scale: (Volts: Input = 5V/Div.; Output = 2V/Div.)  
 Horizontal Scale: (Time: 2μs/Div.)



+VSUPPLY = +15V, -VSUPPLY = -15V

**SMALL SIGNAL RESPONSE**

Vertical Scale: (Volts: Input = 100mV/Div.; Output = 50mV/Div.)  
 Horizontal Scale: (Time: 2μs/Div.)

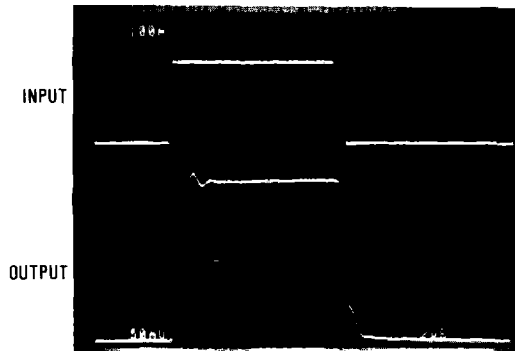

+VSUPPLY = +15V, -VSUPPLY = -15V

**LARGE SIGNAL RESPONSE**

Vertical Scale: (Volts: Input = 2V/Div.; Output = 1V/Div.)  
 Horizontal Scale: (Time: 5μs/Div.)

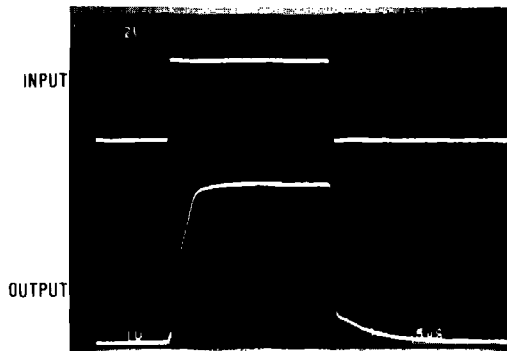

+VSUPPLY = +5V, -VSUPPLY = 0V

**SMALL SIGNAL RESPONSE**

Vertical Scale: (Volts: Input = 100mV/Div.; Output = 50mV/Div.)  
 Horizontal Scale: (Time: 5μs/Div.)

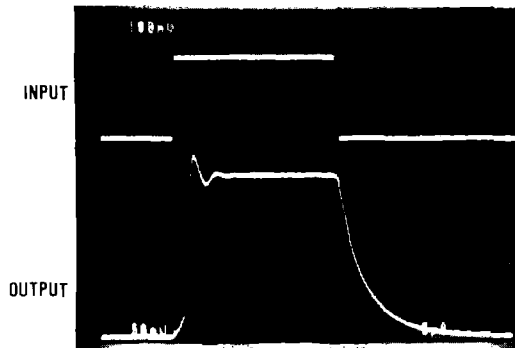

+VSUPPLY = +5V, -VSUPPLY = 0V

**Performance Curves**  $V_S = \pm 2.5V$ ,  $T_A = +25^\circ C$  Unless Otherwise Specified

**OPEN LOOP FREQUENCY RESPONSE**

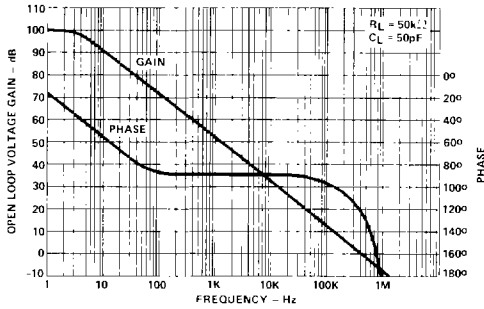

**INPUT OFFSET CURRENT AND BIAS CURRENT vs. TEMPERATURE**

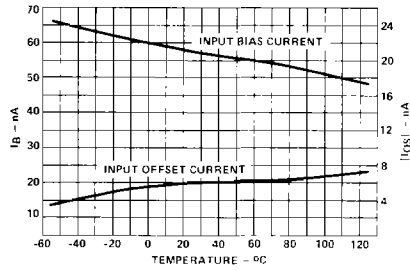

**BANDWIDTH AND PHASE MARGIN vs. LOAD CAPACITANCE**

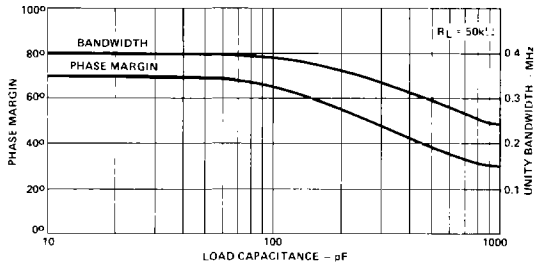

**NORMALIZED AC PARAMETERS vs. SUPPLY VOLTAGE**

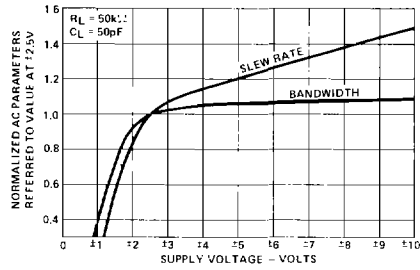

**OUTPUT VOLTAGE SWING vs. FREQUENCY AND SINGLE SUPPLY VOLTAGE**

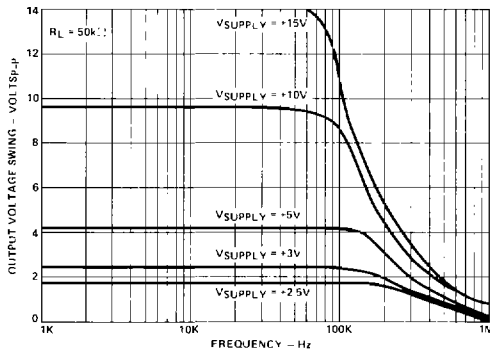

**NORMALIZED AC PARAMETERS vs. TEMPERATURE**

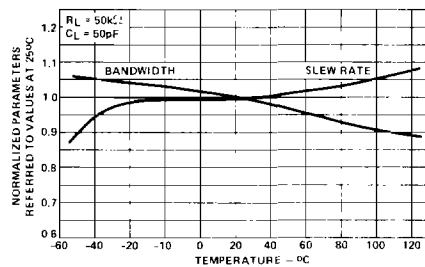

**Performance Curves Continued**  $V_S = \pm 2.5V$ ,  $T_A = +25^\circ C$  Unless Otherwise Specified

**INPUT NOISE vs. FREQUENCY**

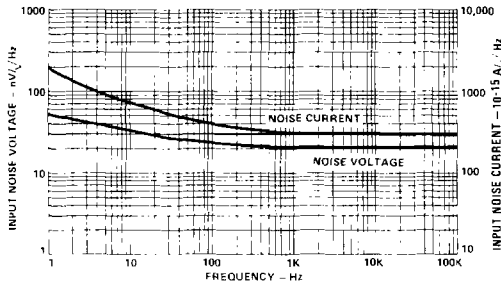

**MAXIMUM OUTPUT VOLTAGE SWING vs. LOAD RESISTANCE AND SINGLE SUPPLY VOLTAGE**

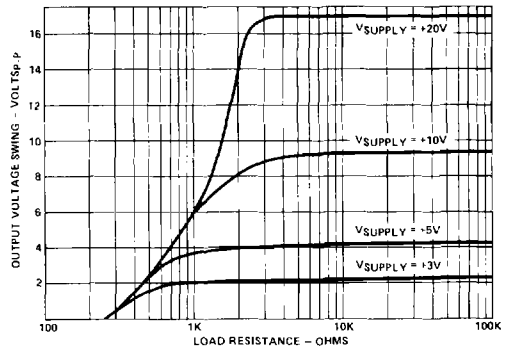

**PSRR AND CMRR vs. FREQUENCY**

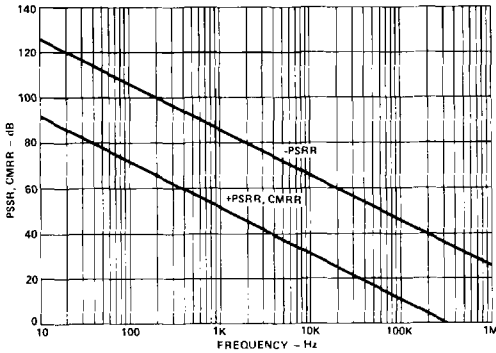

**POWER SUPPLY CURRENT vs. TEMPERATURE AND SINGLE SUPPLY VOLTAGE**

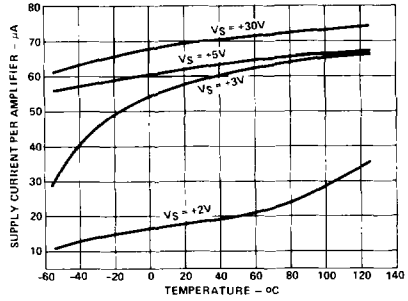

**CHANNEL SEPARATION vs. FREQUENCY**

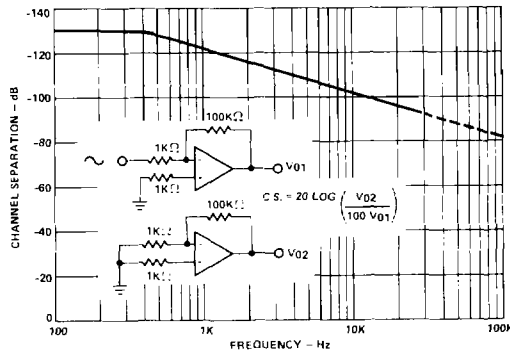

**Schematic**

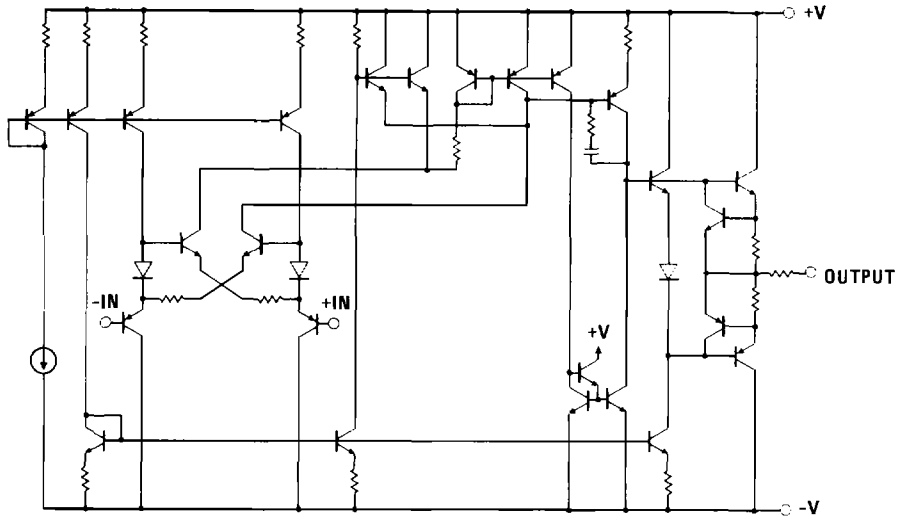

**Die Characteristics**

Transistor Count		
HA-5141	.....	33
HA-5142	.....	66
HA-5144	.....	132
Substrate Potential*	.....	V-
Process	.....	Bipolar-DI
Thermal Constants (°C/W)		
	$\theta_{ja}$	$\theta_{jc}$
HA1-5144 (-2, -5, -7)	101	33
HA1-5144 (/883)	75	22
HA2-5141 (-2, -5, -7)	206	56
HA2-5141 (/883)	168	50
HA2-5142 (-2, -5, -7)	184	50
HA2-5142 (/883)	143	43
HA3-5141 (-5)	90	40
HA3-5142 (-5)	80	20
HA3-5144 (-5)	75	20
HA7-5141 (-2, -5, -7)	210	117
HA7-5141 (/883)	90	40
HA7-5142 (-2, -5, -7)	177	92
HA7-5142 (/883)	80	20

\*The substrate may be left floating (Insulating Die Mount) or it may be mounted on a conductor at V- potential.

NOTE: Consult Harris for LCC/PLCC information.