



HARRIS

HA-2650/55

Dual High Performance Operational Amplifier

**Not Recommended
For New Designs
See HA-5102
or HA-5152**

Features

- SLEW RATE 5V/ μ s
- BANDWIDTH 8MHz
- BIAS CURRENT 35nA
- AVG. OFFSET VOLTAGE DRIFT 8 μ V/ $^{\circ}$ C
- POWER CONSUMPTION 75mW
- SUPPLY VOLTAGE RANGE \pm 2V TO \pm 20V

Applications

- VIDEO AMPLIFIERS
- HIGH IMPEDANCE, WIDEBAND BUFFERS
- INTEGRATORS
- AUDIO AMPLIFIERS
- ACTIVE FILTERS

Description

HA-2650/2655 contains two internally compensated operational amplifiers offering high slew rate and high frequency performance combined with exceptional DC characteristics. 5V/ μ sec slew rate and 8MHz bandwidth make these amplifiers suitable for processing fast, wideband signals extending into the video frequency spectrum. Signal processing accuracy is enhanced by front-end performance that includes 1.5mV offset voltage, 8 μ V/ $^{\circ}$ C offset voltage drift and low offset and bias current (1nA and 35nA respectively). Offset voltage can be trimmed to zero on the devices offered in dual-in-line packages. Signal conditioning is further enhanced by 500M Ω input impedance.

Applications for HA-2650/2655 include video circuit designs such as high impedance buffers, integrators, tone generators and filters. These amplifiers are also ideal components for active filtering of audio and voice signals.

HA-2650/2655 are offered in 14 pin DIP and metal TO-99 packages and are also available in dice form. HA-2650 is specified from -55 $^{\circ}$ C to +125 $^{\circ}$ C. HA-2655 operates from 0 $^{\circ}$ C to +75 $^{\circ}$ C.

Pinouts

**HA1-2650/2655 (CERAMIC DIP)
TOP VIEW**

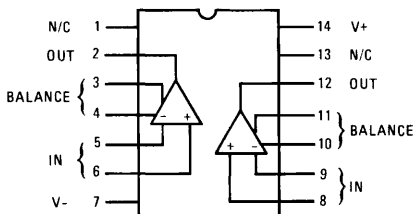

**HA2-2650/2655 (TO-99 METAL CAN)
TOP VIEW**

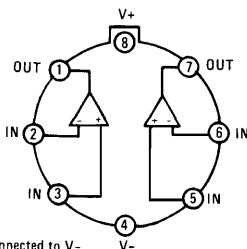

NOTE: Case Connected to V-

Schematic

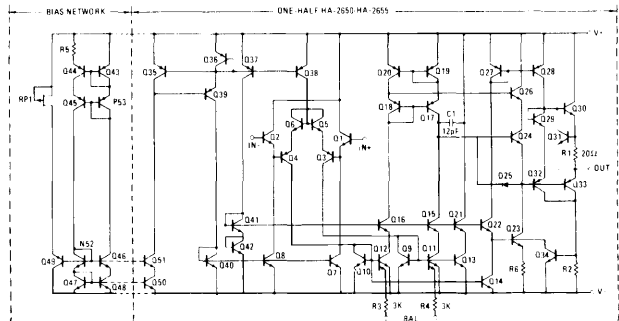

Specifications HA-2650/2655

HA-2650/55

Absolute Maximum Ratings (Note 1)

$T_A = +25^\circ\text{C}$, Unless Otherwise Specified	
Voltage Between V_+ and V_- Terminals	40V
Differential Input Voltage	$\pm 30\text{V}$
Input Voltage (Note 1)	$\pm 15\text{V}$
Output Short Circuit Duration	Indefinite
Power Dissipation (Note 2)	
TO-99	300mW

Operating Temperature Ranges

HA-2650	$-55^\circ\text{C} \leq T_A \leq +125^\circ\text{C}$
HA-2655	$0^\circ\text{C} \leq T_A \leq +75^\circ\text{C}$
Storage Temperature Range:	$-65^\circ\text{C} \leq T_A \leq +150^\circ\text{C}$

Electrical Specifications

$V_+ = +15\text{V D.C.}, V_- = -15\text{V D.C.}$

PARAMETER	TEMP.	HA-2650 -55°C to +125°C			HA-2655 0°C to +75°C			UNITS
		MIN.	TYP.	MAX.	MIN.	TYP.	MAX.	
INPUT CHARACTERISTICS								
Offset Voltage	+25°C		1.5	3		2	5	mV
	Full			5			7	mV
Av. Offset Voltage Drift	Full		8			8		$\mu\text{V}/^\circ\text{C}$
Bias Current	+25°C		35	100		50	200	nA
	Full			200			300	nA
Offset Current	+25°C		1	30		2	60	nA
	Full			60			100	nA
Common Mode Range	Full	± 13			± 13			V
Differential Input Resistance (Note 9)	+25°C	5	20		5	20		$\text{M}\Omega$
Common Mode Input Resistance	+25°C		500			500		$\text{M}\Omega$
Input Capacitance	+25°C		5			5		pF
TRANSFER CHARACTERISTICS								
Large Signal Voltage Gain (Note 3ab)	+25°C	20K	40K		15K	40K		V/V
	Full	15K			10K			V/V
Common Mode Rejection Ratio (Note 4)	+25°C	80	100		74	100		dB
	Full	80			74			dB
OUTPUT CHARACTERISTICS								
Output Voltage Swing (Note 3c)	+25°C	± 13	± 14		± 13	± 14		V
	Full	± 13			± 13			V
Full Power Bandwidth (Notes 5 & 10)	+25°C	30	80		30	80		KHz
Output Current (Note 3a)	+25°C		± 20			± 18		mA
Output Resistance	+25°C		100			100		Ω
TRANSIENT RESPONSE (Note 6)								
Rise Time (Note 7)	+25°C		40	80		40	90	ns
Overshoot (Note 7)	+25°C		15	40		15	40	%
Slew Rate	+25°C	± 2	± 5		± 2	± 5		$\text{V}/\mu\text{s}$
POWER SUPPLY CHARACTERISTICS								
Supply Current	+25°C		2.5	4		3	5	mA
Power Supply Rejection Ratio (Note 8)	+25°C	80	100		74	100		dB
	Full	80			74			dB

- NOTES: 1. For supply voltages less than $\pm 15\text{V}$, the absolute maximum input voltage is equal to the supply voltage.
 2. Derate at $4.7\text{mW}/^\circ\text{C}$ at ambient temperatures above $+110^\circ\text{C}$.
 3. (a) $V_O = \pm 10\text{V}$ (b) $R_L = 2\text{K}$ (c) $R_L = 10\text{K}$
 4. $V_{CM} = \pm 5.0\text{V}$
 5. $A_V = 1, R_L = 2\text{K}, V_O = 20\text{V}_{pp}$
 6. See transient response/slew rate circuit.
 7. $V_{in} = 200\text{mV}$
 8. $\Delta V = \pm 5.0\text{V}$
 9. This parameter value based upon design calculations.
 10. Full power bandwidth guaranteed based upon slew rate measurement $\text{FPBW} = \text{S.R.}/2\pi V_{peak}$.

2
OP AMPs & COMPARATORS

Typical Performance Curves $V_+ = +15V$, $V_- = -15V$, $T_A = +25^\circ C$, Unless Otherwise Specified.

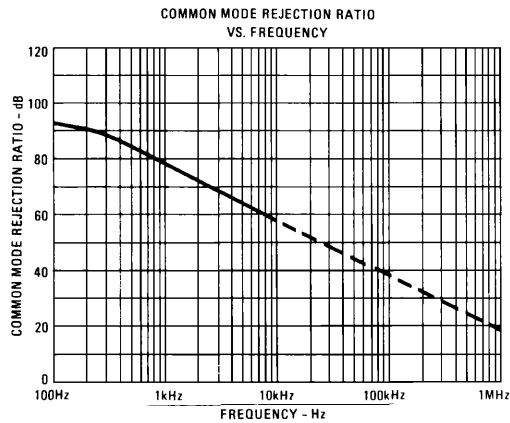
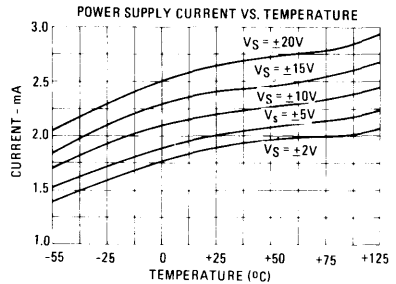
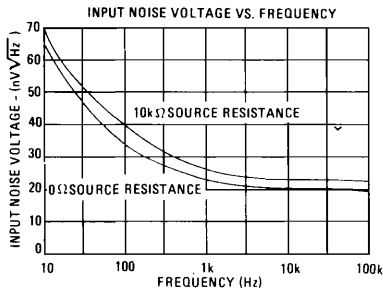
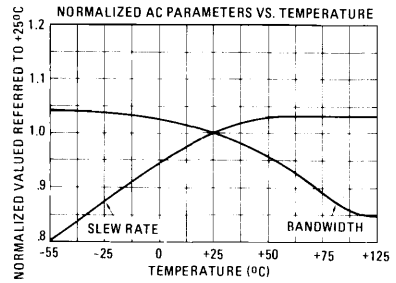
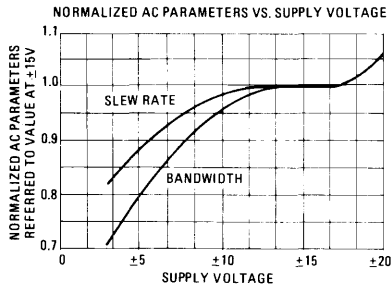
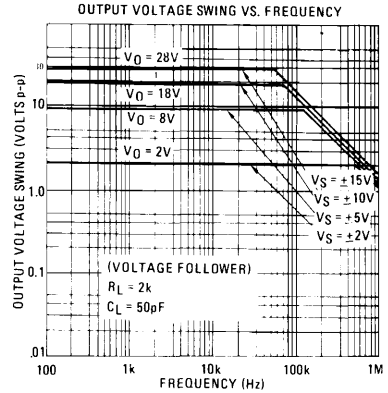
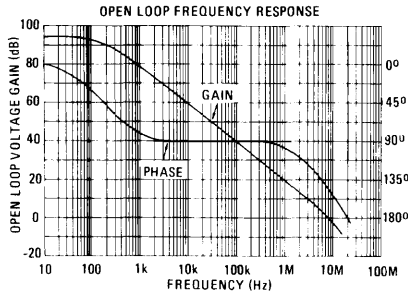

Test Circuits

TRANSIENT RESPONSE/SLEW RATE CIRCUIT

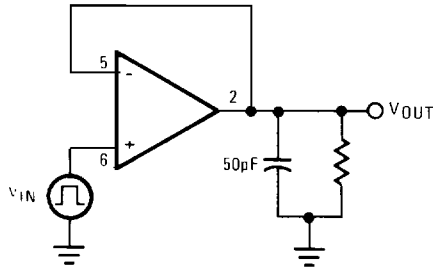

SLEWING WAVEFORM

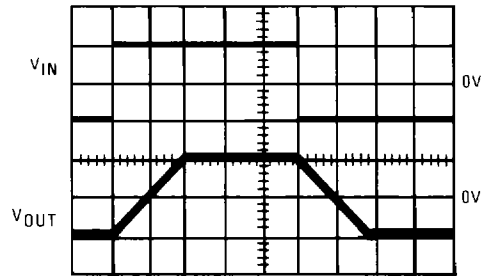

VERTICAL 5V/DIV. HORIZONTAL 1μs/DIV.

Typical Applications

LOW COST HIGH FREQUENCY GENERATOR

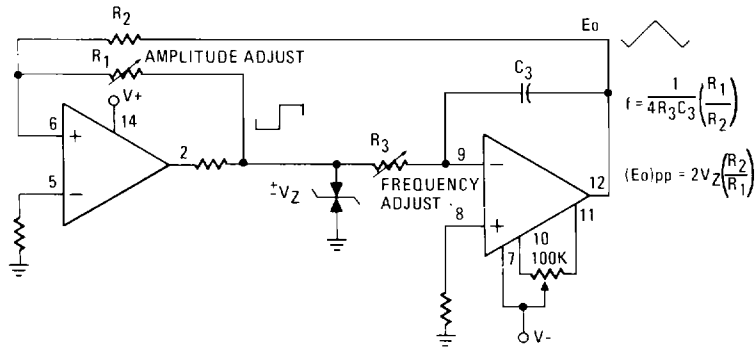

ABSOLUTE - VALUE CIRCUIT

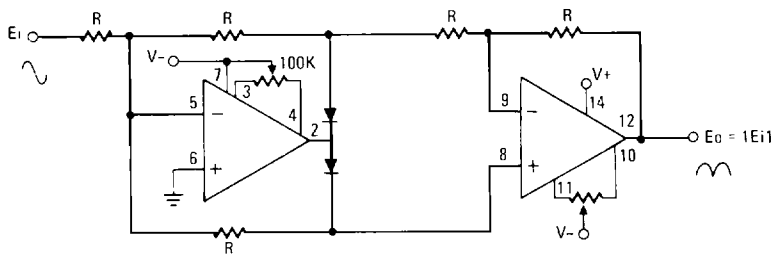

HIGH IMPEDANCE
HIGH GAIN
HIGH FREQUENCY INVERTING AMP

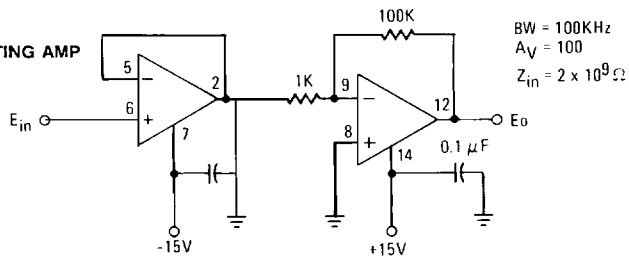

BW = 100KHz
A_V = 100
Z_{in} = 2 x 10⁹Ω