

National Semiconductor is now part of  
Texas Instruments.

Search <http://www.ti.com/> for the latest technical  
information and details on our current products and services.

# LMC6035/LMC6036

## Low Power 2.7V Single Supply CMOS Operational Amplifiers

### General Description

The LMC6035/6 is an economical, low voltage op amp capable of rail-to-rail output swing into loads of 600Ω. LMC6035 is available in a chip sized package (8-Bump micro SMD) using National's micro SMD package technology. Both allow for single supply operation and are guaranteed for 2.7V, 3V, 5V and 15V supply voltage. The 2.7 supply voltage corresponds to the End-of-Life voltage (0.9V/cell) for three NiCd or NiMH batteries in series, making the LMC6035/6 well suited for portable and rechargeable systems. It also features a well behaved decrease in its specifications at supply voltages below its guaranteed 2.7V operation. This provides a "comfort zone" for adequate operation at voltages significantly below 2.7V. Its ultra low input currents ( $I_{IN}$ ) makes it well suited for low power active filter application, because it allows the use of higher resistor values and lower capacitor values. In addition, the drive capability of the LMC6035/6 gives these op amps a broad range of applications for low voltage systems.

### Features

(Typical Unless Otherwise Noted)

- LMC6035 in micro SMD Package
- Guaranteed 2.7V, 3V, 5V and 15V Performance
- Specified for 2 kΩ and 600Ω Loads
- Wide Operating Range: 2.0V to 15.5V
- Ultra Low Input Current: 20fA
- Rail-to-Rail Output Swing
  - @ 600Ω: 200mV from either rail at 2.7V
  - @ 100kΩ: 5mV from either rail at 2.7V
- High Voltage Gain: 126dB
- Wide Input Common-Mode Voltage Range
  - 0.1V to 2.3V at  $V_S = 2.7V$
- Low Distortion: 0.01% at 10kHz
- LMC6035 Dual LMC6036 Quad
- See AN-1112 for micro SMD considerations

### Applications

- Filters
- High Impedance Buffer or Preamplifier
- Battery Powered Electronics
- Medical Instrumentation

### Connection Diagram

8-Bump microSMD

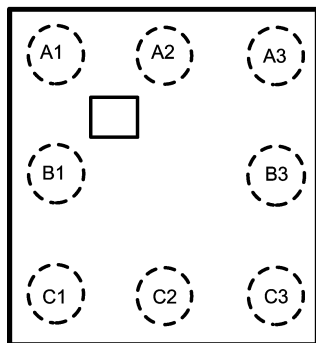

Top View  
(Bump Side Down)

### microSMD Connection Table

Bump Number	LM6035IBP LMC6035IBPX	LMC6035ITL LMC6035ITLX
A1	OUTPUT A	OUTPUT B
B1	IN A <sup>-</sup>	V <sup>+</sup>
C1	IN A <sup>+</sup>	OUTPUT A
C2	V <sup>-</sup>	IN A <sup>-</sup>
C3	IN B <sup>+</sup>	IN A <sup>+</sup>
B3	IN B <sup>-</sup>	V <sup>-</sup>
A3	OUTPUT B	IN B <sup>+</sup>
A2	V <sup>+</sup>	IN B <sup>-</sup>

**Absolute Maximum Ratings** (Note 1)

If Military/Aerospace specified devices are required, please contact the National Semiconductor Sales Office/Distributors for availability and specifications.

ESD Tolerance (Note 2)	
Human Body Model	3000V
Machine Model	300V
Differential Input Voltage	± Supply Voltage
Supply Voltage ( $V^+ - V^-$ )	16V
Output Short Circuit to $V^+$	(Note 8)
Output Short Circuit to $V^-$	(Note 3)
Lead Temperature (soldering, 10 sec.)	260°C
Current at Output Pin	±18mA
Current at Input Pin	±5mA
Current at Power Supply Pin	35mA
Storage Temperature Range	-65°C to +150°C

Junction Temperature (Note 4)

150°C

**Operating Ratings** (Note 1)

Supply Voltage	2.0V to 15.5V
Temperature Range	
LMC6035I and LMC6036I	-40°C ≤ T <sub>J</sub> ≤ +85°C
Thermal Resistance ( $\theta_{JA}$ )	
8-pin MSOP	230°C/W
8-pin SOIC	175°C/W
14-pin SOIC	127°C/W
14-pin TSSOP	137°C/W
8-Bump (6 mil) micro SMD	220°C/W
8-Bump (12 mil) Thin micro SMD	220°C/W

**DC Electrical Characteristics**

Unless otherwise specified, all limits guaranteed for T<sub>J</sub> = 25°C, V<sup>+</sup> = 2.7V, V<sup>-</sup> = 0V, V<sub>CM</sub> = 1.0V, V<sub>O</sub> = 1.35V and R<sub>L</sub> > 1MΩ. **Boldface** limits apply at the temperature extremes.

Symbol	Parameter	Conditions	LMC6035I/LMC6036I			Units
			Min (Note 6)	Typ (Note 5)	Max (Note 6)	
V <sub>OS</sub>	Input Offset Voltage			0.5	5 <b>6</b>	mV
TCV <sub>OS</sub>	Input Offset Voltage Average Drift			2.3		μV/°C
I <sub>IN</sub>	Input Current	(Note 11)		0.02	<b>90</b>	pA
I <sub>OS</sub>	Input Offset Current	(Note 11)		0.01	<b>45</b>	PA
R <sub>IN</sub>	Input Resistance			> 10		Tera Ω
CMRR	Common Mode Rejection Ratio	0.7V ≤ V <sub>CM</sub> ≤ 12.7V, V <sup>+</sup> = 15V	63 <b>60</b>	96		dB
+PSRR	Positive Power Supply Rejection Ratio	5V ≤ V <sup>+</sup> ≤ 15V, V <sub>O</sub> = 2.5V	63 <b>60</b>	93		dB
-PSRR	Negative Power Supply Rejection Ratio	0V ≤ V <sup>-</sup> ≤ -10V, V <sub>O</sub> = 2.5V, V <sup>+</sup> = 5V	74 <b>70</b>	97		dB
V <sub>CM</sub>	Input Common-Mode Voltage Range	V <sup>+</sup> = 2.7V For CMRR ≥ 40dB		-0.1	0.3 <b>0.5</b>	V
			2.0 <b>1.7</b>	2.3		
		V <sup>+</sup> = 3V For CMRR ≥ 40dB		-0.3	0.1 <b>0.3</b>	V
			2.3 <b>2.0</b>	2.6		
		V <sup>+</sup> = 5V For CMRR ≥ 50dB		-0.5	-0.2 <b>0.0</b>	V
			4.2 <b>3.9</b>	4.5		
		V <sup>+</sup> = 15V For CMRR ≥ 50dB		-0.5	-0.2 <b>0.0</b>	V
			14.0 <b>13.7</b>	14.4		

**DC Electrical Characteristics** (Continued)

Unless otherwise specified, all limits guaranteed for  $T_J = 25^\circ\text{C}$ ,  $V^+ = 2.7\text{V}$ ,  $V^- = 0\text{V}$ ,  $V_{\text{CM}} = 1.0\text{V}$ ,  $V_O = 1.35\text{V}$  and  $R_L > 1\text{M}\Omega$ .

**Boldface** limits apply at the temperature extremes.

Symbol	Parameter	Conditions		LMC6035/LMC6036			Units
				Min (Note 6)	Typ (Note 5)	Max (Note 6)	
$A_V$	Large Signal Voltage Gain (Note 7)	$R_L = 600\Omega$	Sourcing	100 <b>75</b>	1000		V/mV
			Sinking	25 <b>20</b>	250		V/mV
		$R_L = 2\text{k}\Omega$	Sourcing		2000		V/mV
			Sinking		500		V/mV
$V_O$	Output Swing	$V^+ = 2.7\text{V}$ $R_L = 600\Omega$ to $1.35\text{V}$		2.0 <b>1.8</b>	2.5		V
					0.2	0.5 <b>0.7</b>	
		$V^+ = 2.7\text{V}$ $R_L = 2\text{k}\Omega$ to $1.35\text{V}$		2.4 <b>2.2</b>	2.62		V
					0.07	0.2 <b>0.4</b>	
		$V^+ = 15\text{V}$ $R_L = 600\Omega$ to $7.5\text{V}$		13.5 <b>13.0</b>	14.5		V
					0.36	1.25 <b>1.50</b>	
		$V^+ = 15\text{V}$ , $R_L = 2\text{ k}\Omega$ to $7.5\text{V}$		14.2 <b>13.5</b>	14.8		V
					0.12	0.4 <b>0.5</b>	
$I_O$	Output Current	$V_O = 0\text{V}$	Sourcing	4 <b>3</b>	8		mA
		$V_O = 2.7\text{V}$	Sinking	3 <b>2</b>	5		
$I_S$	Supply Current	LMC6035 for Both Amplifiers $V_O = 1.35\text{V}$			0.65	1.6 <b>1.9</b>	mA
		LMC6036 for All Four Amplifiers $V_O = 1.35\text{V}$			1.3	2.7 <b>3.0</b>	

**AC Electrical Characteristics**

Unless otherwise specified, all limits guaranteed for  $T_J = 25^\circ\text{C}$ ,  $V^+ = 2.7\text{V}$ ,  $V^- = 0\text{V}$ ,  $V_{\text{CM}} = 1.0\text{V}$ ,  $V_O = 1.35\text{V}$  and  $R_L > 1\text{M}\Omega$ .

**Boldface** limits apply at the temperature extremes.

Symbol	Parameter	Conditions	Typ (Note 5)	Units
SR	Slew Rate	(Note 9)	1.5	V/ $\mu\text{s}$
GBW	Gain Bandwidth Product	$V^+ = 15\text{V}$	1.4	MHz
$\theta_m$	Phase Margin		48	$^\circ$
$G_m$	Gain Margin		17	dB
	Amp-to-Amp Isolation	(Note 10)	130	dB
$e_n$	Input-Referred Voltage Noise	$f = 1\text{kHz}$ $V_{\text{CM}} = 1\text{V}$	27	nV/ $\sqrt{\text{Hz}}$
$i_n$	Input Referred Current Noise	$f = 1\text{kHz}$	0.2	fA/ $\sqrt{\text{Hz}}$
THD	Total Harmonic Distortion	$f = 10\text{kHz}$ , $A_V = -10$ $R_L = 2\text{k}\Omega$ , $V_O = 8\text{V}_{\text{PP}}$	0.01	%

## AC Electrical Characteristics (Continued)

Unless otherwise specified, all limits guaranteed for  $T_J = 25^\circ\text{C}$ ,  $V^+ = 2.7\text{V}$ ,  $V^- = 0\text{V}$ ,  $V_{CM} = 1.0\text{V}$ ,  $V_O = 1.35\text{V}$  and  $R_L > 1\text{M}\Omega$ . **Boldface** limits apply at the temperature extremes.

Symbol	Parameter	Conditions	Typ (Note 5)	Units
		$V^+ = 10\text{V}$		

**Note 1:** Absolute Maximum Ratings indicate limits beyond which damage to the device may occur. Operating Ratings indicate conditions for which the device is intended to be functional, but specific performance is not guaranteed. For guaranteed specifications and the test conditions, see the Electrical Characteristics.

**Note 2:** Human body model,  $1.5\text{k}\Omega$  in series with  $100\text{pF}$ .

**Note 3:** Applies to both single-supply and split-supply operation. Continuous short circuit operation at elevated ambient temperature can result in exceeding the maximum allowed junction temperature of  $150^\circ\text{C}$ . Output currents in excess of  $30\text{mA}$  over long term may adversely affect reliability.

**Note 4:** The maximum power dissipation is a function of  $T_{J(\text{MAX})}$ ,  $\theta_{JA}$ , and  $T_A$ . The maximum allowable power dissipation at any ambient temperature is  $P_D = (T_{J(\text{MAX})} - T_A) / \theta_{JA}$ . All numbers apply for packages soldered directly onto a PC board with no air flow.

**Note 5:** Typical Values represent the most likely parametric norm or one sigma value.

**Note 6:** All limits are guaranteed by testing or statistical analysis.

**Note 7:**  $V^+ = 15\text{V}$ ,  $V_{CM} = 7.5\text{V}$  and  $R_L$  connected to  $7.5\text{V}$ . For Sourcing tests,  $7.5\text{V} \leq V_O \leq 11.5\text{V}$ . For Sinking tests,  $3.5\text{V} \leq V_O \leq 7.5\text{V}$ .

**Note 8:** Do not short circuit output to  $V^+$  when  $V^+$  is greater than  $13\text{V}$  or reliability will be adversely affected.

**Note 9:**  $V^+ = 15\text{V}$ . Connected as voltage follower with  $10\text{V}$  step input. Number specified is the slower of the positive and negative slew rates.

**Note 10:** Input referred,  $V^+ = 15\text{V}$  and  $R_L = 100\text{k}\Omega$  connected to  $7.5\text{V}$ . Each amp excited in turn with  $1\text{kHz}$  to produce  $V_O = 12\text{V}_{PP}$ .

**Note 11:** Guaranteed by design.

# Typical Performance Characteristics

Unless otherwise specified,  $V_S = 2.7V$ , single supply,  $T_A = 25^\circ C$

25°C

Supply Current vs. Supply Voltage (Per Amplifier)

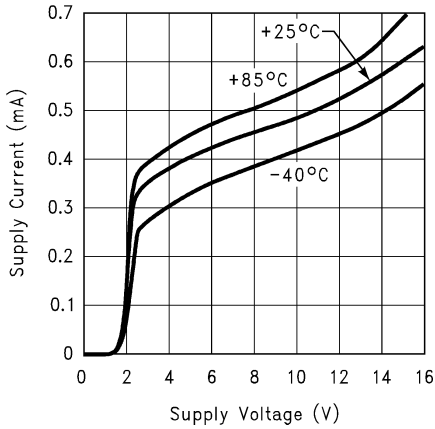

01283052

Input Current vs. Temperature

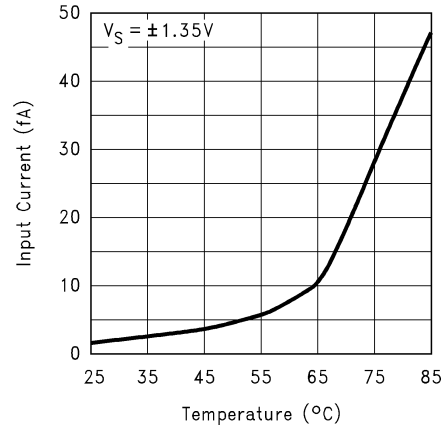

01283053

Sourcing Current vs. Output Voltage

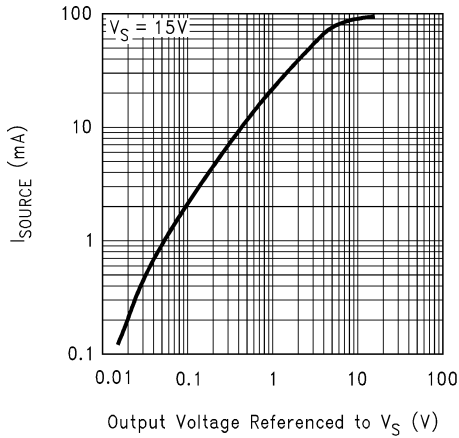

01283054

Sourcing Current vs. Output Voltage

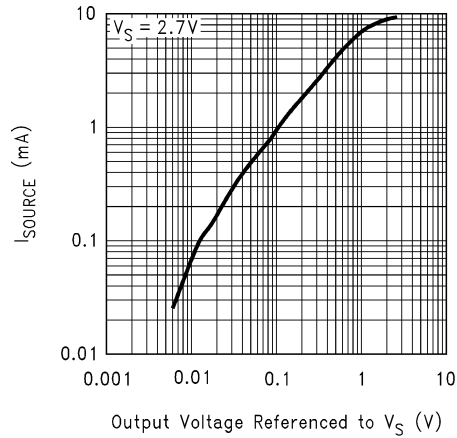

01283055

Sinking Current vs. Output Voltage

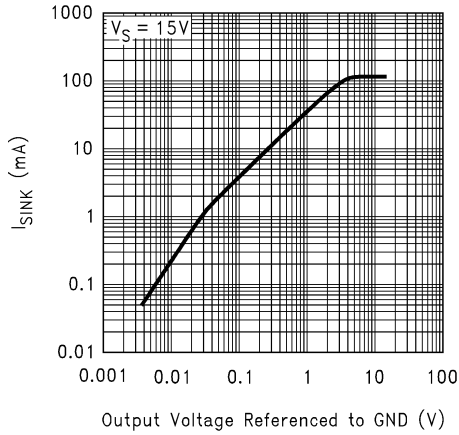

01283056

Sinking Current vs. Output Voltage

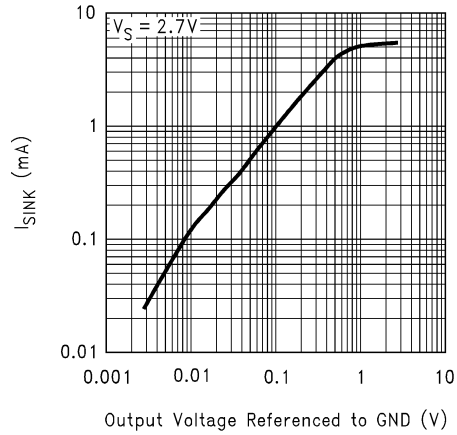

01283057

**Typical Performance Characteristics** Unless otherwise specified,  $V_S = 2.7V$ , single supply,  $T_A = 25^\circ C$  (Continued)

**Output Voltage Swing vs. Supply Voltage**

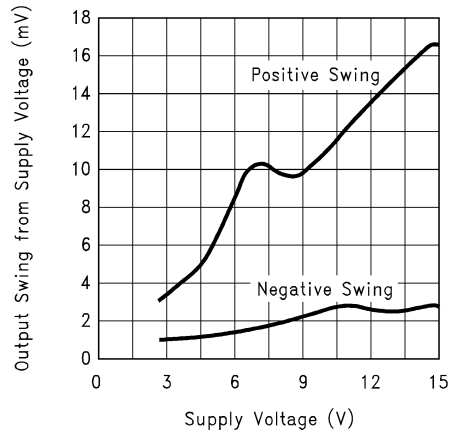

01283058

**Input Noise vs. Frequency**

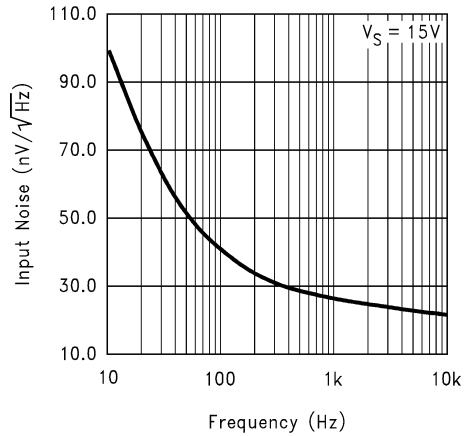

01283059

**Input Noise vs. Frequency**

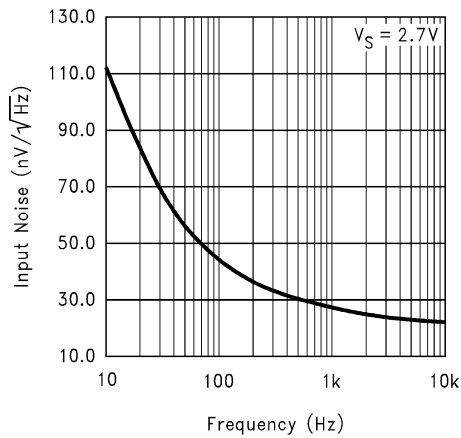

01283060

**Amp to Amp Isolation vs. Frequency**

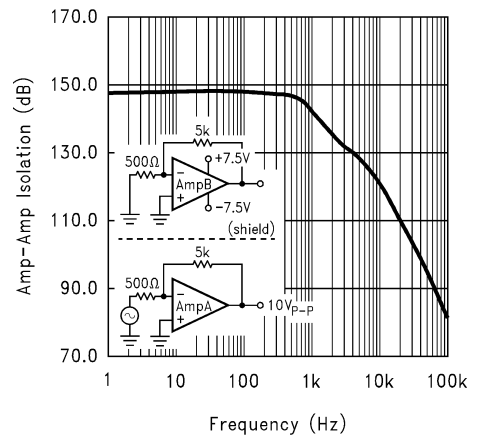

01283061

**Amp to Amp Isolation vs. Frequency**

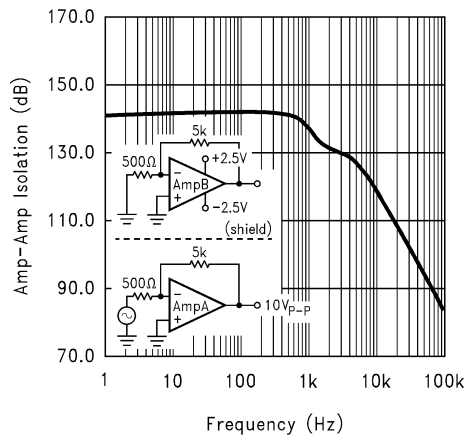

01283062

**+PSRR vs. Frequency**

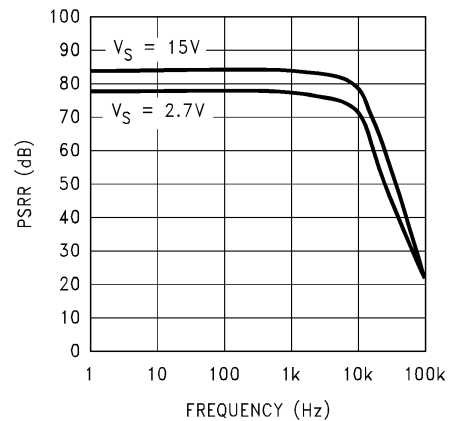

01283032

**Typical Performance Characteristics** Unless otherwise specified,  $V_S = 2.7V$ , single supply,  $T_A = 25^\circ C$  (Continued)

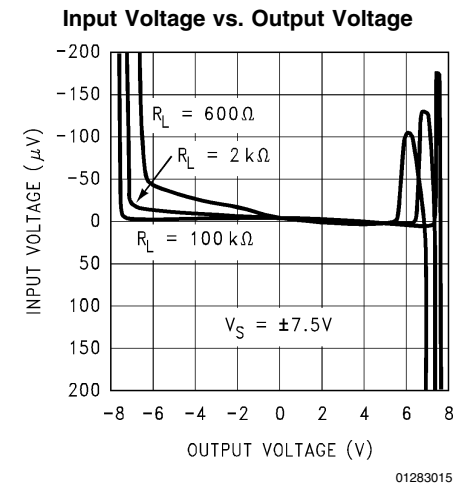
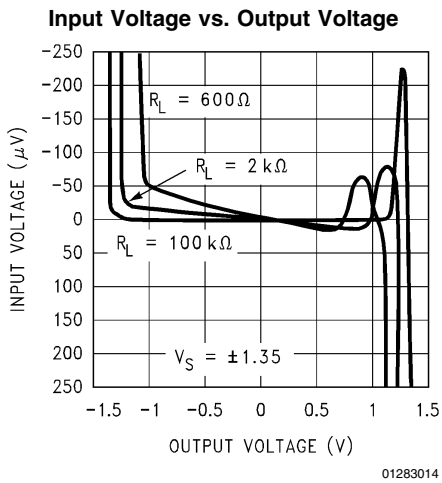
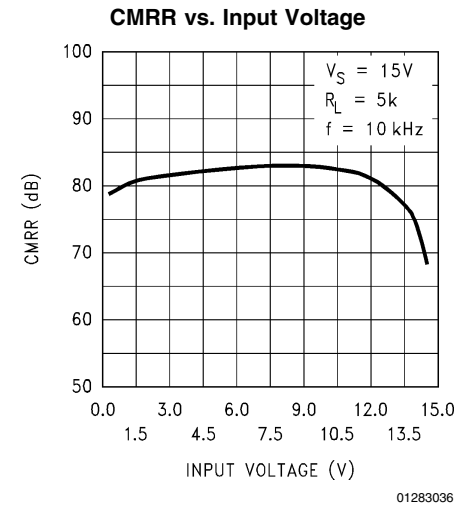
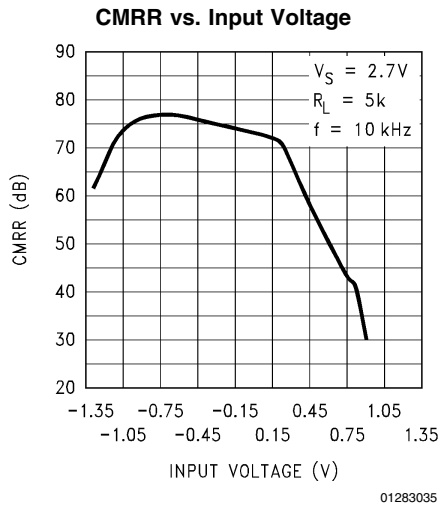
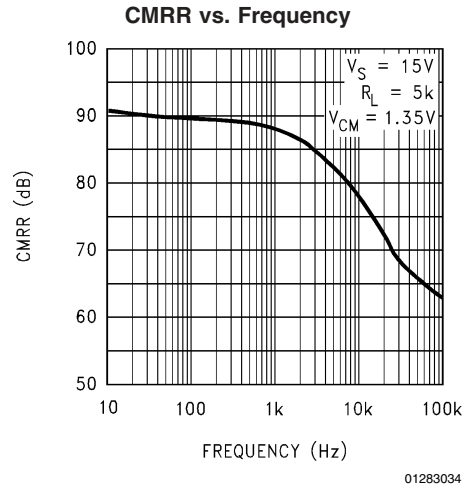
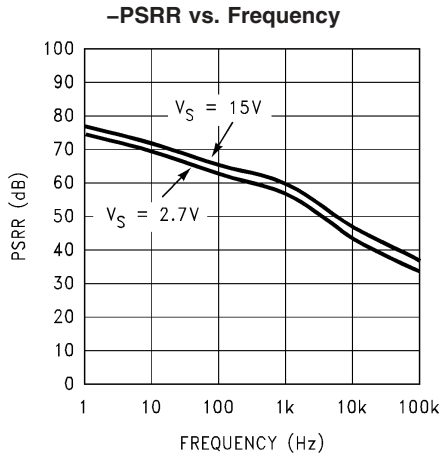



**Typical Performance Characteristics** Unless otherwise specified,  $V_S = 2.7V$ , single supply,  $T_A = 25^\circ C$  (Continued)

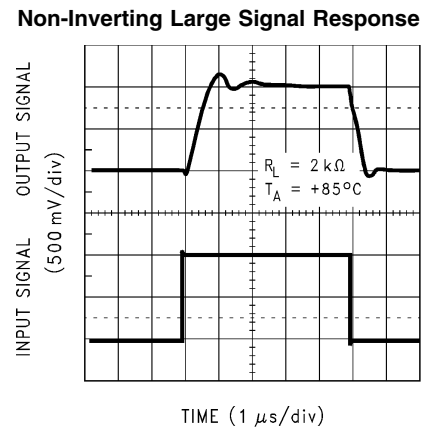
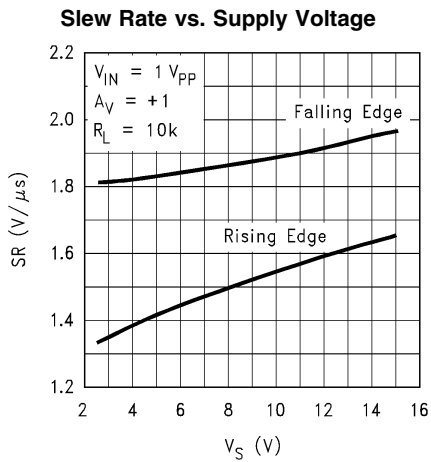
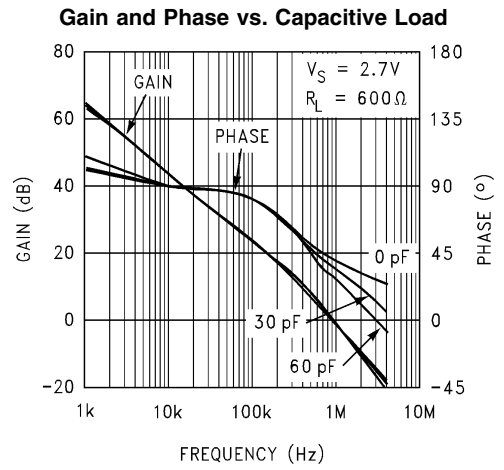
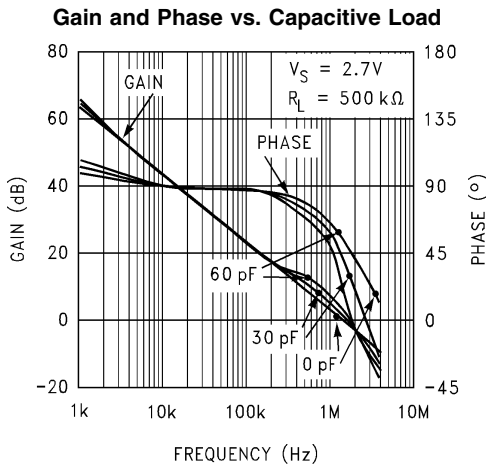
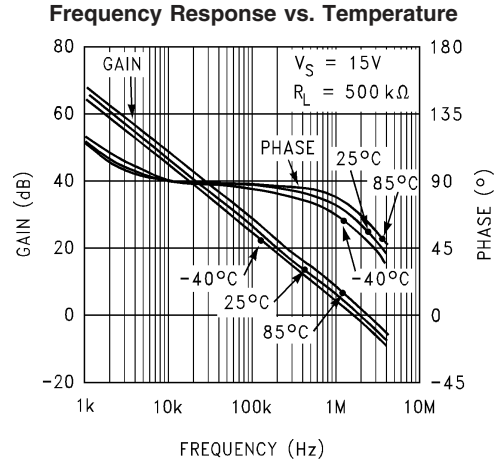
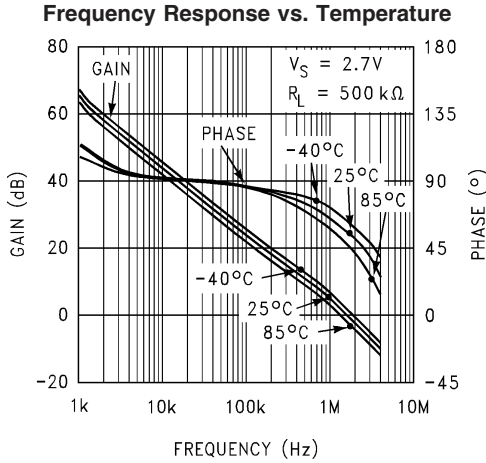

**Typical Performance Characteristics** Unless otherwise specified,  $V_S = 2.7V$ , single supply,  $T_A = 25^\circ C$  (Continued)

**Non-Inverting Large Signal Response**

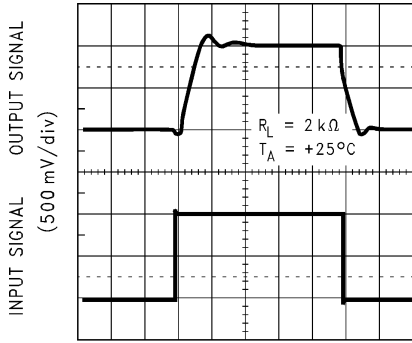

TIME (1  $\mu s$ /div)

01283021

**Non-Inverting Large Signal Response**

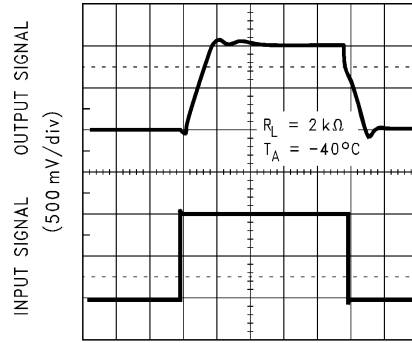

TIME (1  $\mu s$ /div)

01283022

**Non-Inverting Small Signal Response**

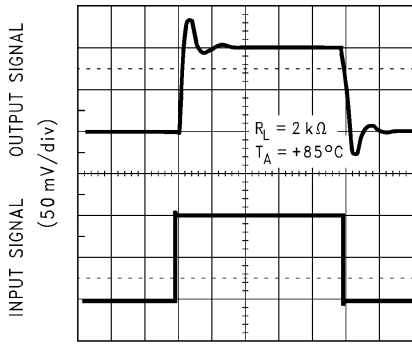

TIME (1  $\mu s$ /div)

01283023

**Non-Inverting Small Signal Response**

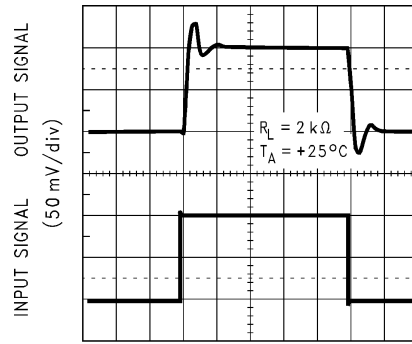

TIME (1  $\mu s$ /div)

01283024

**Non-Inverting Large Signal Response**

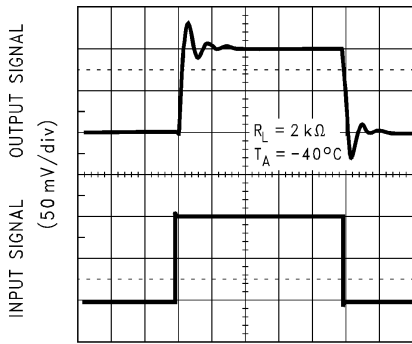

TIME (1  $\mu s$ /div)

01283025

**Inverting Large Signal Response**

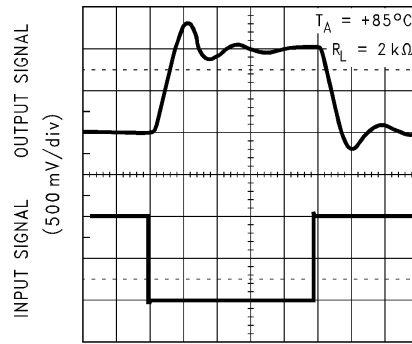

TIME (1  $\mu s$ /div)

01283026

**Typical Performance Characteristics** Unless otherwise specified,  $V_S = 2.7V$ , single supply,  $T_A = 25^\circ C$  (Continued)

**Inverting Large Signal Response**

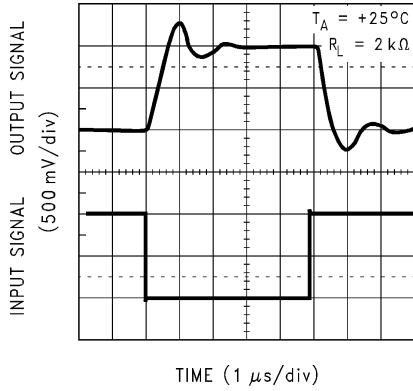

01283027

**Inverting Large Signal Response**

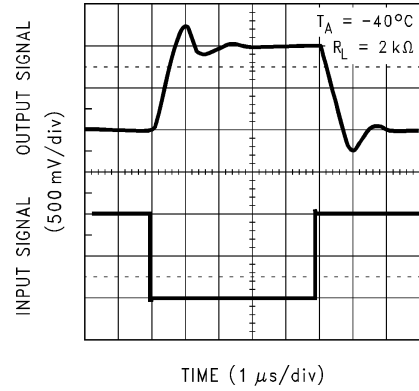

01283028

**Inverting Small Signal Response**

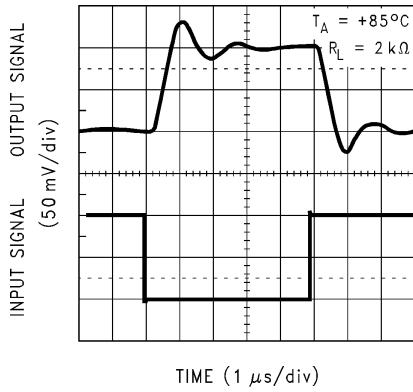

01283029

**Inverting Small Signal Response**

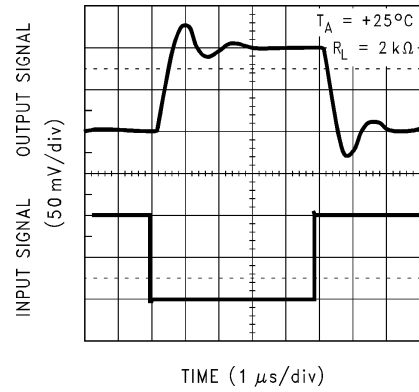

01283030

**Inverting Small Signal Response**

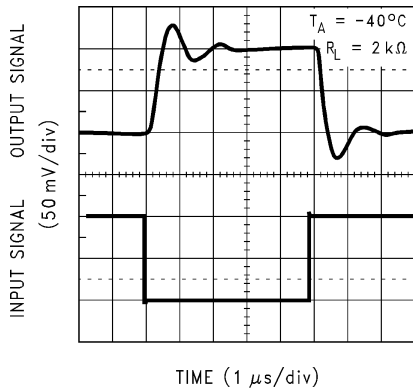

01283031

**Stability vs. Capacitive Load**

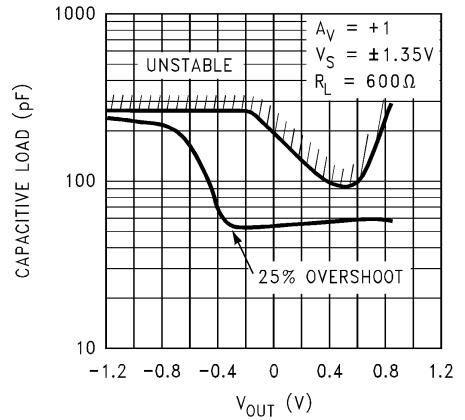

01283038

**Typical Performance Characteristics** Unless otherwise specified,  $V_S = 2.7V$ , single supply,  $T_A = 25^\circ C$  (Continued)

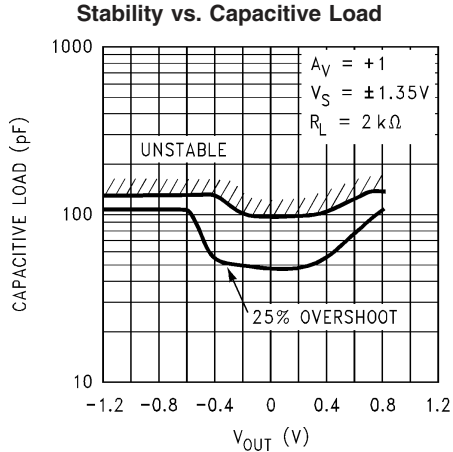

01283039

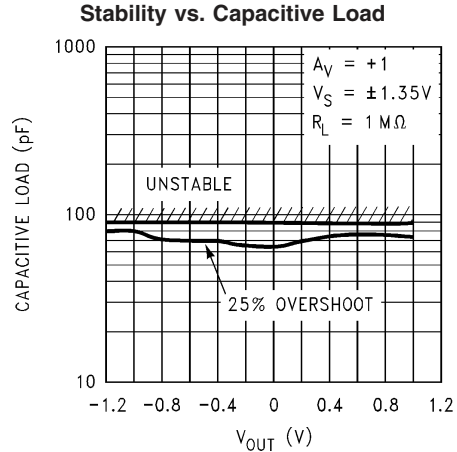

01283040

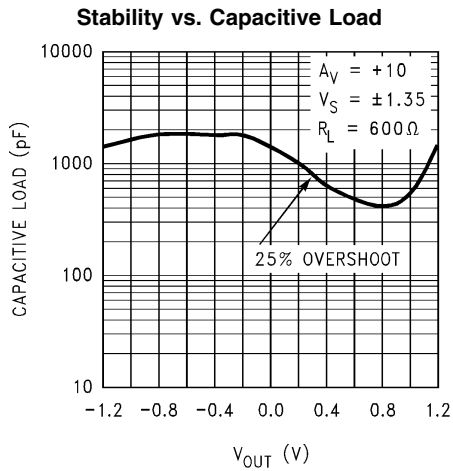

01283041

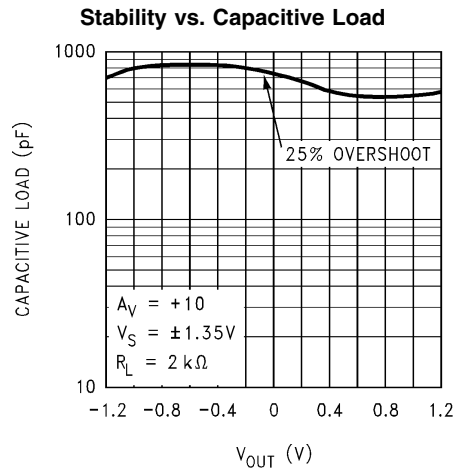

01283042

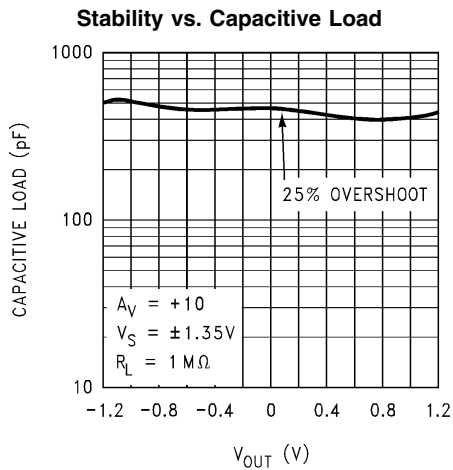

01283043

# 1.0 Application Notes

## 1.1 Background

The LMC6035/6 is exceptionally well suited for low voltage applications. A desirable feature that the LMC6035/6 brings to low voltage applications is its output drive capability—a hallmark for National's CMOS amplifiers. The circuit of *Figure 1* illustrates the drive capability of the LMC6035/6 at 3V of supply. It is a differential output driver for a one-to-one audio transformer, like those used for isolating ground from the telephone lines. The transformer (T1) loads the op amps with about 600Ω of AC load, at 1 kHz. Capacitor C1 functions to block DC from the low winding resistance of T1. Although the value of C1 is relatively high, its load reactance ( $X_c$ ) is negligible compared to inductive reactance ( $X_l$ ) of T1.

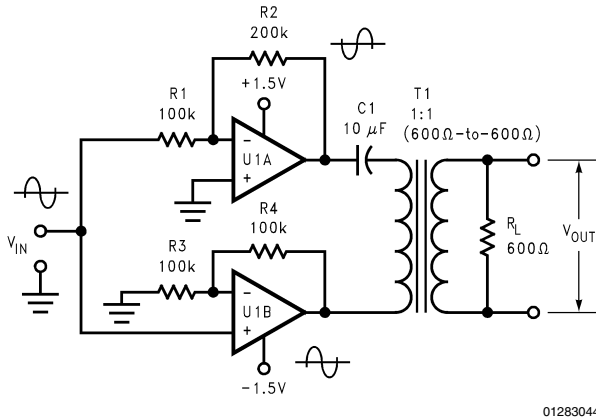
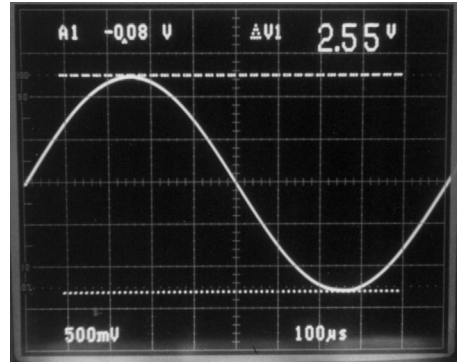

FIGURE 1. Differential Driver

The circuit in *Figure 1* consists of one input signal and two output signals. U1A amplifies the input with an inverting gain of  $-2$ , while the U1B amplifies the input with a non-inverting gain of  $+2$ . Since the two outputs are  $180^\circ$  out of phase with each other, the gain across the differential output is 4. As the differential output swings between the supply rails, one of the op amps sources the current to the load, while the other op amp sinks the current.

How good a CMOS op amp can sink or source a current is an important factor in determining its output swing capability. The output stage of the LMC6035/6—like many op amps—sources and sinks output current through two complementary transistors in series. This “totem pole” arrangement translates to a channel resistance ( $R_{dson}$ ) at each supply rail which acts to limit the output swing. Most CMOS op amps are able to swing the outputs very close to the rails—except, however, under the difficult conditions of low supply voltage and heavy load. The LMC6035/6 exhibits exceptional output swing capability under these conditions.

The scope photos of *Figure 2* and *Figure 3* represent measurements taken directly at the output (relative to GND) of U1A, in *Figure 1*. *Figure 2* illustrates the output swing capability of the LMC6035, while *Figure 3* provides a benchmark comparison. (The benchmark op amp is another low voltage (3V) op amp manufactured by one of our reputable competitors.)



01283045

FIGURE 2. Output Swing Performance of the LMC6035 per the Circuit of *Figure 1*

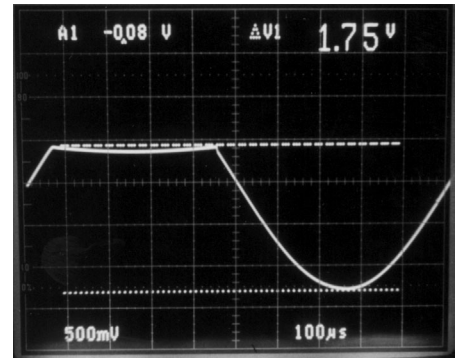

01283046

FIGURE 3. Output Swing Performance of Benchmark Op Amp per the Circuit of *Figure 1*

Notice the superior drive capability of LMC6035 when compared with the benchmark measurement—even though the benchmark op amp uses twice the supply current.

Not only does the LMC6035/6 provide excellent output swing capability at low supply voltages, it also maintains high open loop gain ( $A_{VOL}$ ) with heavy loads. To illustrate this, the LMC6035 and the benchmark op amp were compared for their distortion performance in the circuit of *Figure 1*. The graph of *Figure 4* shows this comparison. The y-axis represents percent Total Harmonic Distortion (THD plus noise) across the loaded secondary of T1. The x-axis represents the input amplitude of a 1 kHz sine wave. (Note that T1 loses about 20% of the voltage to the voltage divider of  $R_L$  (600Ω) and T1's winding resistances—a performance deficiency of the transformer.)

## 1.0 Application Notes (Continued)

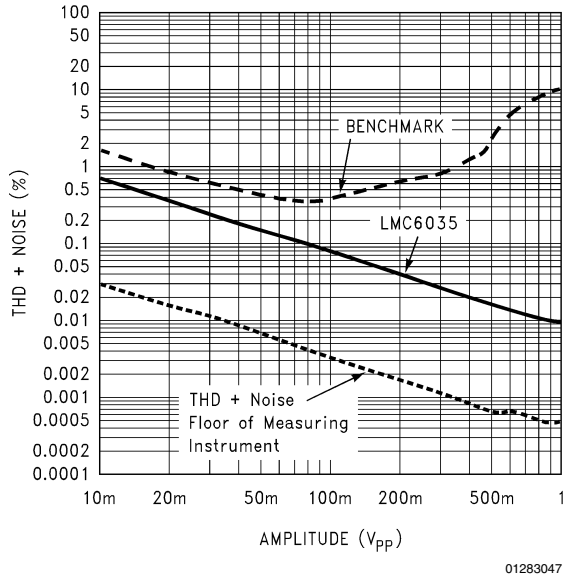

**FIGURE 4. THD+Noise Performance of LMC6035 and “Benchmark” per Circuit of Figure 1**

Figure 4 shows the superior distortion performance of LMC6035/6 over that of the benchmark op amp. The heavy loading of the circuit causes the  $A_{VOL}$  of the benchmark part to drop significantly which causes increased distortion.

### 1.2 APPLICATION CIRCUITS

#### 1.2.1 Low-Pass Active Filter

A common application for low voltage systems would be active filters, in cordless and cellular phones for example. The ultra low input currents ( $I_{IN}$ ) of the LMC6035/6 makes it well suited for low power active filter applications, because it allows the use of higher resistor values and lower capacitor values. This reduces power consumption and space.

Figure 5 shows a low pass, active filter with a Butterworth (maximally flat) frequency response. Its topology is a Sallen and Key filter with unity gain. Note the normalized component values in parenthesis which are obtainable from standard filter design handbooks. These values provide a 1Hz cutoff frequency, but they can be easily scaled for a desired cutoff frequency ( $f_c$ ). The bold component values of Figure 5 provide a cutoff frequency of 3kHz. An example of the scaling procedure follows Figure 5.

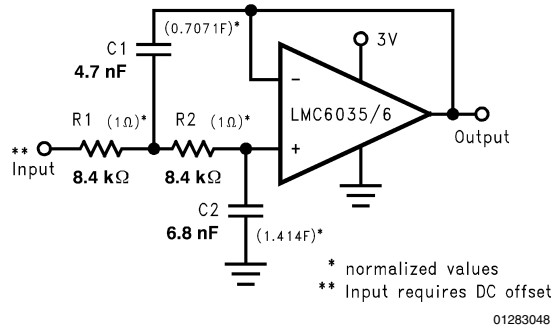

**FIGURE 5. 2-Pole, 3kHz, Active, Sallen and Key, Lowpass Filter with Butterworth Response**

#### 1.2.1.1 Low-Pass Frequency Scaling Procedure

The actual component values represented in bold of Figure 5 were obtained with the following scaling procedure:

1. First determine the frequency scaling factor (FSF) for the desired cutoff frequency. Choosing  $f_c$  at 3kHz, provides the following FSF computation:

$$FSF = 2\pi \times 3\text{kHz (desired cutoff freq.)} = 18.84 \times 10^3$$

2. Then divide all of the normalized capacitor values by the FSF as follows:  $C1' = C_{(\text{Normalized})}/FSF$   $C1' = 0.707/18.84 \times 10^3 = 37.93 \times 10^{-6}$   $C2' = 1.414/18.84 \times 10^3 = 75.05 \times 10^{-6}$  ( $C1'$  and  $C2'$ : prior to impedance scaling)

3. Last, choose an impedance scaling factor ( $Z$ ). This  $Z$  factor can be calculated from a standard value for  $C2$ . Then  $Z$  can be used to determine the remaining component values as follows:

$$Z = C2'/C2(\text{chosen}) = 75.05 \times 10^{-6}/6.8\text{nF} = 8.4\text{k}$$

$$C1 = C1'/Z = 37.93 \times 10^{-6}/8.4\text{k} = 4.52\text{nF}$$

$$\text{(Standard capacitor value chosen for } C1 \text{ is } 4.7\text{nF}) \quad R1 = R1(\text{normalized}) \times Z = 1\Omega \times 8.4\text{k} = 8.4\text{k}\Omega \quad R2 = R2(\text{normalized}) \times Z = 1\Omega \times 8.4\text{k} = 8.4\text{k}\Omega$$

(Standard value chosen for  $R1$  and  $R2$  is **8.45k $\Omega$** )

#### 1.2.2 High Pass Active Filter

The previous low-pass filter circuit of Figure 5 converts to a high-pass active filter per Figure 6.

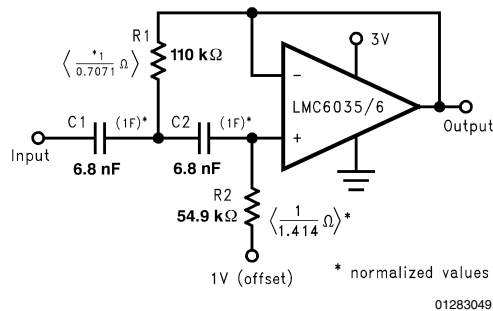

**FIGURE 6. 2 Pole, 300Hz, Sallen and Key, High-Pass Filter**

# 1.0 Application Notes (Continued)

## 1.2.2.1 High-Pass Frequency Scaling Procedure

Choose a standard capacitor value and scale the impedances in the circuit according to the desired cutoff frequency (300Hz) as follows:  $C = C1 = C2$   $Z = 1 \text{ Farad}/C_{(\text{chosen})} \times 2\pi \times (\text{desired cutoff freq.}) = 1 \text{ Farad}/6.8\text{nF} \times 2\pi \times 300 \text{ Hz} = 78.05\text{k}$

$R1 = Z \times R1_{(\text{normalized})} = 78.05\text{k} \times (1/0.707) = 110.4\text{k}\Omega$   
(Standard value chosen for R1 is **110kΩ**)

$R2 = Z \times R2_{(\text{normalized})} = 78.05\text{k} \times (1/1.414) = 55.2\text{k}\Omega$   
(Standard value chosen for R1 is **54.9kΩ**)

## 1.2.3 Dual Amplifier Bandpass Filter

The dual amplifier bandpass (DABP) filter features the ability to independently adjust  $f_c$  and Q. In most other bandpass topologies, the  $f_c$  and Q adjustments interact with each other. The DABP filter also offers both low sensitivity to component values and high Qs. The following application of Figure 7, provides a 1kHz center frequency and a Q of 100.

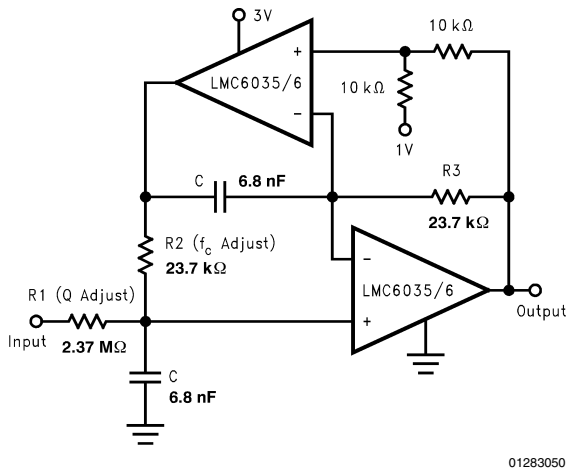

FIGURE 7. 2 Pole, 1kHz Active, Bandpass Filter

### 1.2.3.1 DABP Component Selection Procedure

Component selection for the DABP filter is performed as follows:

1. First choose a center frequency ( $f_c$ ). Figure 7 represents component values that were obtained from the following computation for a center frequency of 1kHz.  $R2 = R3 = 1/(2\pi f_c C)$  Given:  $f_c = 1\text{kHz}$  and  $C_{(\text{chosen})} = 6.8\text{nF}$   
 $R2 = R3 = 1/(2\pi \times 1\text{kHz} \times 6.8\text{nF}) = 23.4\text{k}\Omega$   
(Chosen standard value is **23.7kΩ**)
2. Then compute R1 for a desired Q ( $f_c/BW$ ) as follows:  
 $R1 = Q \times R2$ . Choosing a Q of 100,  $R1 = 100 \times 23.7\text{k}\Omega = 2.37\text{M}\Omega$ .

## 1.3 PRINTED-CIRCUIT-BOARD LAYOUT FOR HIGH-IMPEDANCE WORK

It is generally recognized that any circuit which must operate with < 1000pA of leakage current requires special layout of the PC board. If one wishes to take advantage of the ultra-low bias current of the LMC6035/6, typically < 0.04pA, it is essential to have an excellent layout. Fortunately, the techniques for obtaining low leakages are quite simple. First, the user must not ignore the surface leakage of the PC board, even though it may at times appear acceptably low. Under conditions of high humidity, dust or contamination, the surface leakage will be appreciable.

To minimize the effect of any surface leakage, lay out a ring of foil completely surrounding the LMC6035 or LMC6036 inputs and the terminals of capacitors, diodes, conductors, resistors, relay terminals, etc. connected to the op amp's inputs. See Figure 8. To have a significant effect, guard rings should be placed on both the top and bottom of the PC board. This PC foil must then be connected to a voltage which is at the same voltage as the amplifier inputs, since no leakage current can flow between two points at the same potential. For example, a PC board trace-to-pad resistance of  $10^{12}\Omega$ , which is normally considered a very large resistance, could leak 5pA if the trace were a 5V bus adjacent to the pad of an input. This would cause a 100 times degradation from the amplifiers actual performance. However, if a guard ring is held within 5mV of the inputs, then even a resistance of  $10^{11}\Omega$  would cause only 0.05pA of leakage current, or perhaps a minor (2:1) degradation of the amplifier's performance. See Figure 9a, b, c for typical connections of guard rings for standard op amp configurations. If both inputs are active and at high impedance, the guard can be tied to ground and still provide some protection; see Figure 9 d.

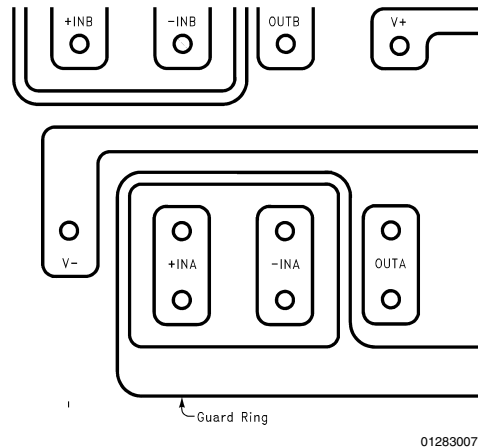
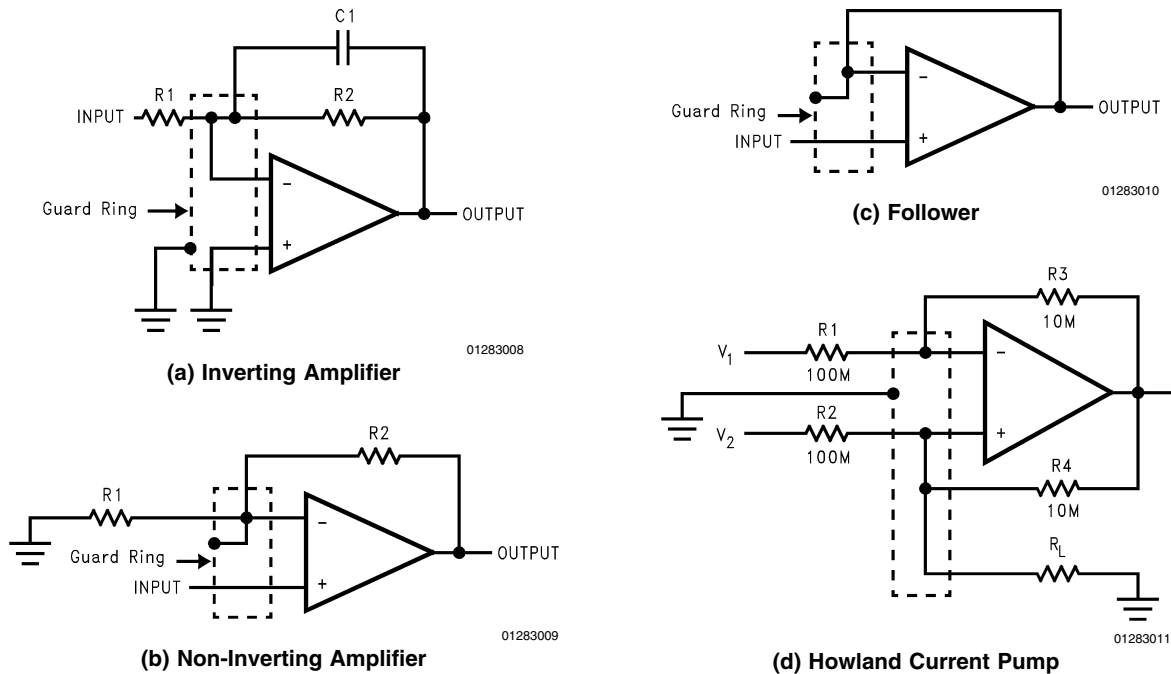

FIGURE 8. Example, using the LMC6036 of Guard Ring in P.C. Board Layout

## 1.0 Application Notes (Continued)



**FIGURE 9. Guard Ring Connections**

### 1.3.1 CAPACITIVE LOAD TOLERANCE

Like many other op amps, the LMC6035/6 may oscillate when its applied load appears capacitive. The threshold of oscillation varies both with load and circuit gain. The configuration most sensitive to oscillation is a unity-gain follower. See the Typical Performance Characteristics.

The load capacitance interacts with the op amp's output resistance to create an additional pole. If this pole frequency is sufficiently low, it will degrade the op amp's phase margin so that the amplifier is no longer stable at low gains. As shown in *Figure 10*, the addition of a small resistor ( $50\Omega$ – $100\Omega$ ) in series with the op amp's output, and a capacitor ( $5\text{pF}$ – $10\text{pF}$ ) from inverting input to output pins, returns the phase margin to a safe value without interfering with lower-frequency circuit operation. Thus, larger values of capacitance can be tolerated without oscillation. Note that in all cases, the output will ring heavily when the load capacitance is near the threshold for oscillation.

### 1.4 Micro SMD Considerations

Contrary to what might be guessed, the micro SMD package does not follow the trend of smaller packages having higher thermal resistance. LMC6035 in micro SMD has thermal resistance of  $220^\circ\text{C/W}$  compared to  $230^\circ\text{C/W}$  in MSOP. Even when driving a  $600\Omega$  load and operating from  $\pm 7.5\text{V}$  sup-

plies, the maximum temperature rise will be under  $4.5^\circ\text{C}$ . For application information specific to micro SMD, see Application note AN-1112.

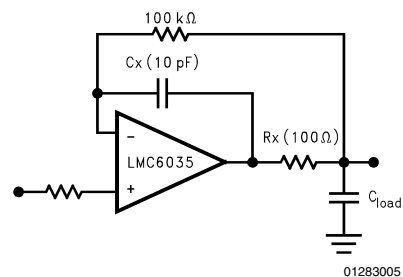

**FIGURE 10.  $R_x$ ,  $C_x$  Improve Capacitive Load Tolerance**

Capacitive load driving capability is enhanced by using a pull up resistor to  $V^+$  (*Figure 11*). Typically a pull up resistor conducting  $500\mu\text{A}$  or more will significantly improve capacitive load responses. The value of the pull up resistor must be determined based on the current sinking capability of the amplifier with respect to the desired output swing. Open loop gain of the amplifier can also be affected by the pull up resistor (see Electrical Characteristics).



# 1.0 Application Notes (Continued)

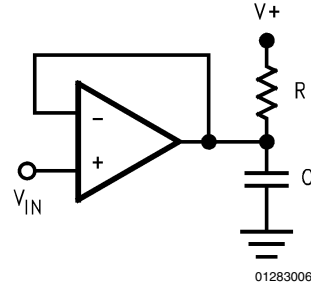
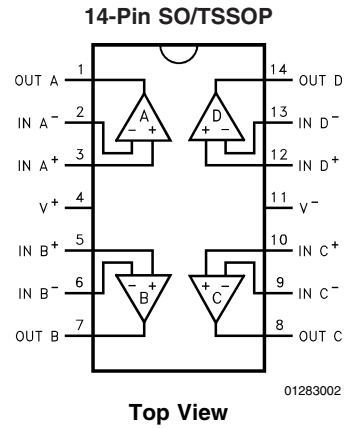
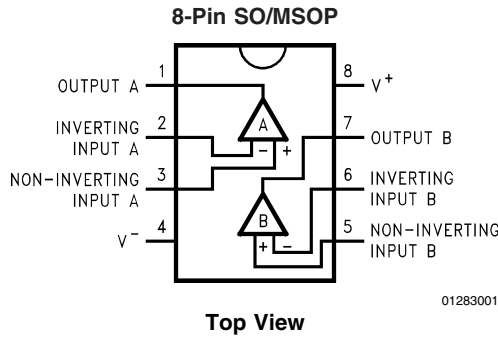

FIGURE 11. Compensating for Large Capacitive Loads with a Pull Up Resistor

## Connection Diagrams



## Ordering Information

Package	Temperature Range	Transport Media	NSC Drawing
	Industrial -40°C to +85°C		
8-pin Small Outline (SO)	LMC6035IM	Rails	M08A
	LMC6035IMX	2.5k Units Tape and Reel	
8-pin Mini Small Outline (MSOP)	LMC6035IMM	1k Units Tape and Reel	MUA08A
	LMC6035IMMX	3.5k Units Tape and Reel	
14-pin Small Outline (SO)	LMC6036IM	Rails	M14A
	LMC6036IMX	2.5k Units Tape and Reel	
14-pin Thin Shrink Small Outline (TSSOP)	LMC6036IMT	Rails	MTC14
	LMC6036IMTX	2.5k Units Tape and Reel	
8-Bump micro SMD (Small Bump)	LMC6035IBP	250 Units Tape and Reel	BPA08FFB
	LMC6035IBPX	3k Units Tape and Reel	
8-Bump Thin micro SMD (Large Bump)	LMC6035ITL	250 Units Tape and Reel	TLA08JQA
	LMC6035ITLX	3k Units Tape and Reel	

**Physical Dimensions** inches (millimeters)

unless otherwise noted

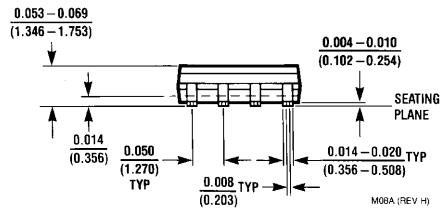
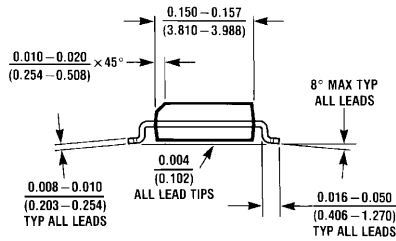
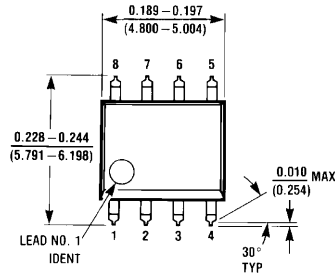

**8-Lead (0.150" Wide) Molded Small Outline Package, JEDEC NS Package Number M08A**

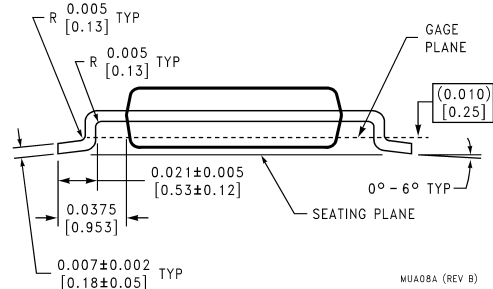
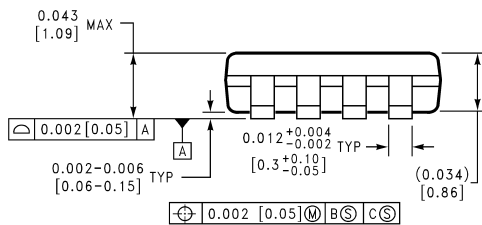
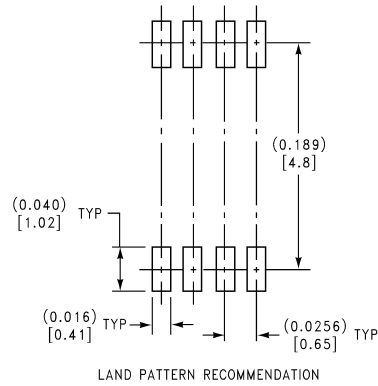
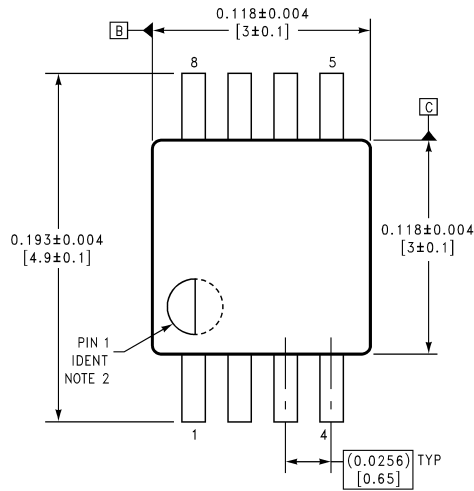

**8-Lead (0.150" Wide) Molded Mini Small Outline Package, JEDEC NS Package Number MUA08A**

**Physical Dimensions** inches (millimeters) unless otherwise noted (Continued)

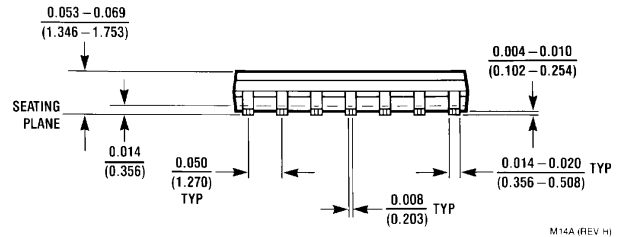
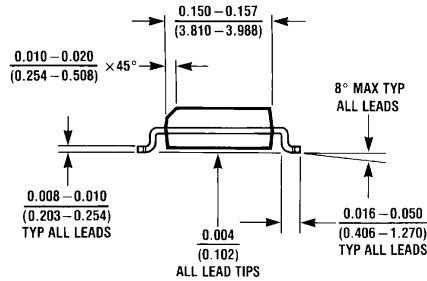
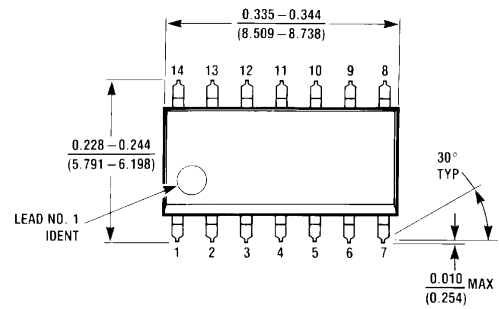

M14A (REV H)

**14-Lead (0.150" Wide) Molded Small Outline Package, JEDEC NS Package Number M14A**

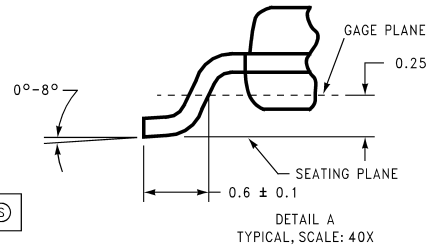
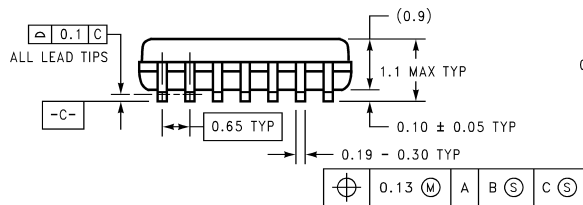
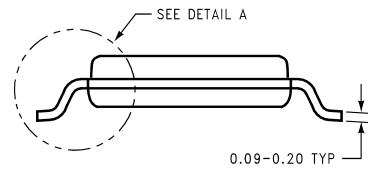
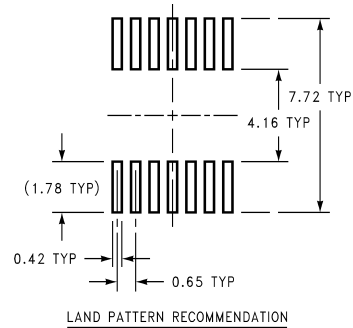
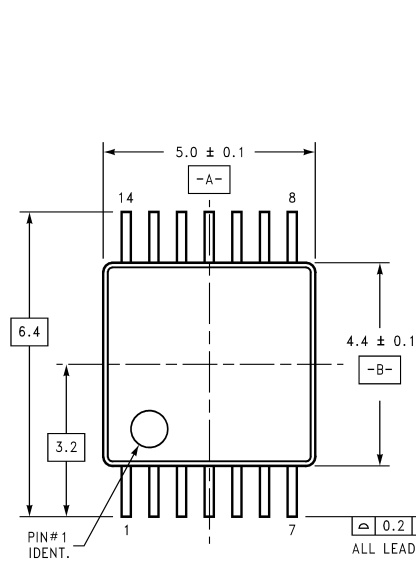

DIMENSIONS ARE IN MILLIMETERS

MTC14 (REV C)

**14-Pin TSSOP NS Package Number MTC14**

**Physical Dimensions** inches (millimeters) unless otherwise noted (Continued)

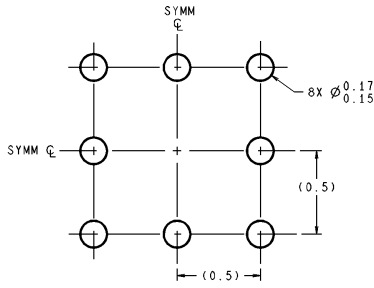

DIMENSIONS ARE IN MILLIMETERS

**LAND PATTERN RECOMMENDATION**

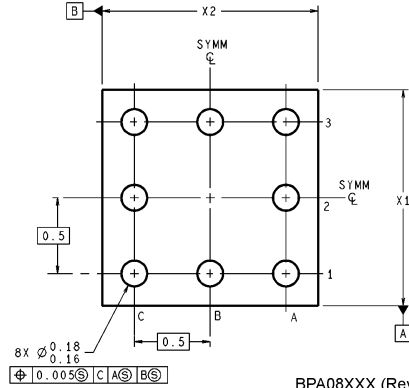
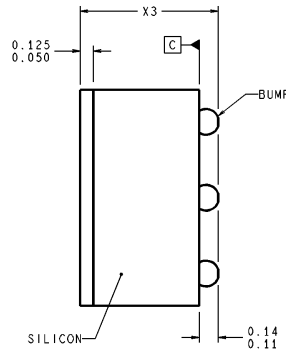
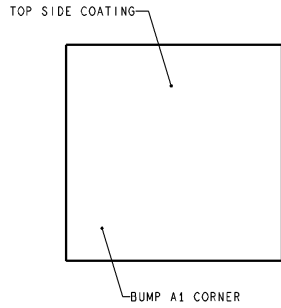

BPA08XXX (Rev C)

NOTE: UNLESS OTHERWISE SPECIFIED.

1. EPOXY COATING.
2. 63Sn/37Pb EUTECTIC BUMP.
3. RECOMMEND NON-SOLDER MASK DEFINED LANDING PAD.
4. PIN A1 IS ESTABLISHED BY LOWER LEFT CORNER WITH RESPECT TO TEXT ORIENTATION PINS ARE NUMBERED COUNTERCLOCKWISE.
5. XXX IN DRAWING NUMBER REPRESENTS PACKAGE SIZE VARIATION WHERE X1 IS PACKAGE WIDTH, X2 IS PACKAGE LENGTH AND X3 IS PACKAGE HEIGHT.
6. REFERENCE JEDEC REGISTRATION MO-211, VARIATION BC.

**8-Bump micro SMD (6 mil bumps)**  
**NS Package Number BPA08FFB**  
**X<sub>1</sub> = 1.412mm X<sub>2</sub> = 1.412mm X<sub>3</sub> = 0.850mm**

**Physical Dimensions** inches (millimeters) unless otherwise noted (Continued)

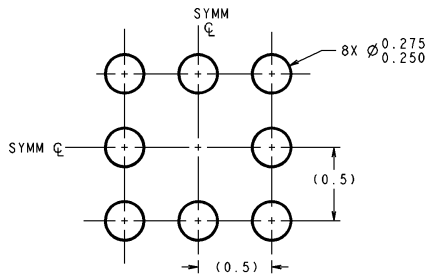

**LAND PATTERN RECOMMENDATION**

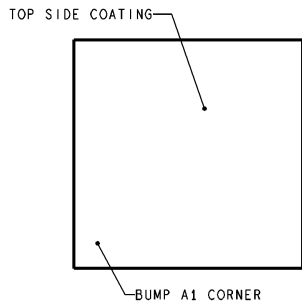

**DIMENSIONS ARE IN MILLIMETERS**

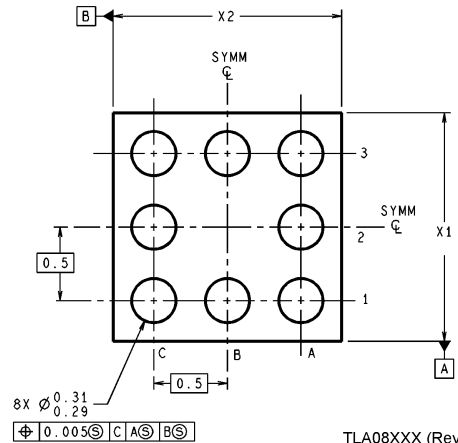
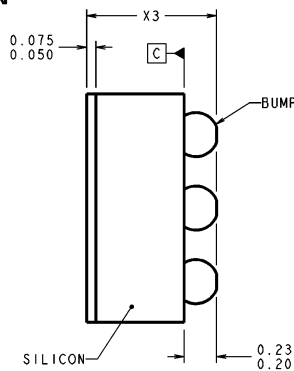

TLA08XXX (Rev A)

NOTE: UNLESS OTHERWISE SPECIFIED.

1. EPOXY COATING.
2. 63Sn/37Pb EUTECTIC BUMP.
3. RECOMMEND NON-SOLDER MASK DEFINED LANDING PAD.
4. PIN A1 IS ESTABLISHED BY LOWER LEFT CORNER WITH RESPECT TO TEXT ORIENTATION PINS ARE NUMBERED COUNTERCLOCKWISE.
5. XXX IN DRAWING NUMBER REPRESENTS PACKAGE SIZE VARIATION WHERE X1 IS PACKAGE WIDTH, X2 IS PACKAGE LENGTH AND X3 IS PACKAGE HEIGHT.
6. REFERENCE JEDEC REGISTRATION MO-211, VARIATION BC.

**8-Bump Thin micro SMD (12 mil bumps)  
NS Package Number TLA08JQA  
X<sub>1</sub> = 1.717mm X<sub>2</sub> = 1.869mm X<sub>3</sub> = 0.600mm**

**LIFE SUPPORT POLICY**

NATIONAL'S PRODUCTS ARE NOT AUTHORIZED FOR USE AS CRITICAL COMPONENTS IN LIFE SUPPORT DEVICES OR SYSTEMS WITHOUT THE EXPRESS WRITTEN APPROVAL OF THE PRESIDENT AND GENERAL COUNSEL OF NATIONAL SEMICONDUCTOR CORPORATION. As used herein:

1. Life support devices or systems are devices or systems which, (a) are intended for surgical implant into the body, or (b) support or sustain life, and whose failure to perform when properly used in accordance with instructions for use provided in the labeling, can be reasonably expected to result in a significant injury to the user.
2. A critical component is any component of a life support device or system whose failure to perform can be reasonably expected to cause the failure of the life support device or system, or to affect its safety or effectiveness.

**National Semiconductor Corporation**  
Americas  
Email: support@nsc.com

www.national.com

**National Semiconductor Europe**  
Fax: +49 (0) 180-530 85 86  
Email: europe.support@nsc.com  
Deutsch Tel: +49 (0) 69 9508 6208  
English Tel: +44 (0) 870 24 0 2171  
Français Tel: +33 (0) 1 41 91 8790

**National Semiconductor Asia Pacific Customer Response Group**  
Tel: 65-2544466  
Fax: 65-2504466  
Email: ap.support@nsc.com

**National Semiconductor Japan Ltd.**  
Tel: 81-3-5639-7560  
Fax: 81-3-5639-7507