

HA-2620, HA-2622, HA-2625

**100MHz, High Input Impedance, Very Wideband,
Uncompensated Operational Amplifiers**

November 1996

Features

- Gain Bandwidth Product ($A_v \geq 5$) 100MHz
- High Input Impedance 500M Ω
- Low Input Bias Current 1nA
- Low Input Offset Current 1nA
- Low Input Offset Voltage 0.5mV
- High Gain 150kV/V
- Slew Rate 35V/ μ s
- Output Short Circuit Protection

Applications

- Video and RF Amplifier
- Pulse Amplifier
- Audio Amplifiers and Filters
- High-Q Active Filters
- High Speed Comparators
- Low Distortion Oscillator

Ordering Information

PART NUMBER (BRAND)	TEMP. RANGE ($^{\circ}$ C)	PACKAGE	PKG. NO.
HA2-2620-2	-55 to 125	8 Pin Metal Can	T8.C
HA2-2622-2	-55 to 125	8 Pin Metal Can	T8.C
HA2-2625-5	0 to 75	8 Pin Metal Can	T8.C
HA3-2625-5	0 to 75	8 Ld PDIP	E8.3
HA7-2620-2	-55 to 125	8 Ld CERDIP	F8.3A
HA7-2622-2	-55 to 125	8 Ld CERDIP	F8.3A
HA7-2625-5	0 to 75	8 Ld CERDIP	F8.3A
HA9P2625-5 (H26255)	0 to 75	8 Ld SOIC	M8.15
HA9P2625-9 (H26259)	-40 to 85	8 Ld SOIC	M8.15

Description

HA-2620/2622/2625 are bipolar operational amplifiers that feature very high input impedance (500M Ω , HA-2620) coupled with wideband AC performance. The high resistance of the input stage is complemented by low offset voltage (0.5mV, HA-2620) and low bias and offset current (1nA, HA-2620) to facilitate accurate signal processing. Input offset can be reduced further by means of an external nulling potentiometer. The 100MHz gain bandwidth product (HA-2620/2622/2625 are stable for closed loop gains greater than 5), 35V/ μ s slew rate and 150kV/V open loop gain enables HA-2620/2622/2625 to perform high gain amplification of very fast, wideband signals. These dynamic characteristics, coupled with fast settling times, make these amplifiers ideally suited to pulse amplification designs as well as high frequency (e.g., video) applications. The frequency response of the amplifier can be tailored to exact design requirements by means of an external bandwidth control capacitor connected from the Comp pin to GND.

In addition to its application in pulse and video amplifier designs, HA-2620/2622/2625 is particularly suited to other high performance designs such as high-gain low distortion audio amplifiers, high-Q and wideband active filters and high-speed comparators. For more information, please refer to Application Notes AN509, AN519 and AN546.

The HA-2620 and HA-2622 are both offered as /883 Military Grade with the HA-2622 also available in CLCC packages. MIL-STD-883 data sheets are available upon request Harris AnswerFAX (407-724-7800) Document #3701.

Pinouts

HA-2620/22 (CERDIP)
HA-2625 (CERDIP, PDIP, SOIC)
TOP VIEW

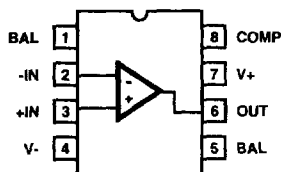

HA-2620, HA-2622, HA-2625
(METAL CAN)
TOP VIEW

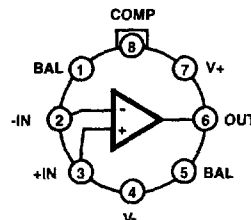

HA-2620, HA-2622, HA-2625

Absolute Maximum Ratings

Supply Voltage (Between V+ and V- Terminals) 45V
 Differential Input Voltage 12V
 Peak Output Current Full Short Circuit Protection

Operating Conditions

Temperature Range
 HA-2620/HA-2622-2 -55°C to 125°C
 HA-2625-5 0°C to 75°C
 HA-2625-9 -40°C to 85°C

Thermal Information

Thermal Resistance (Typical, Note 1) θ_{JA} (°C/W) θ_{JC} (°C/W)
 PDIP Package 96 N/A
 CERDIP Package 135 50
 SOIC Package 157 N/A
 Metal Can Package 165 80
 Maximum Junction Temperature (Hermetic Package) 175°C
 Maximum Junction Temperature (Plastic Package) 150°C
 Maximum Storage Temperature Range -65°C to 150°C
 Maximum Lead Temperature (Soldering 10s) 300°C
 (SOIC - Lead Tips Only)

CAUTION: Stresses above those listed in "Absolute Maximum Ratings" may cause permanent damage to the device. This is a stress only rating and operation of the device at these or any other conditions above those indicated in the operational sections of this specification is not implied.

NOTE:

- θ_{JA} is measured with the component mounted on an evaluation PC board in free air.

Electrical Specifications $V_{SUPPLY} = \pm 15V$, Unless Otherwise Specified

PARAMETER	TEMP. (°C)	HA-2620-2			HA-2622-2			HA-2625-5, -9			UNITS
		MIN	TYP	MAX	MIN	TYP	MAX	MIN	TYP	MAX	
INPUT CHARACTERISTICS											
Offset Voltage (Note 3)	25	-	0.5	4	-	3	5	-	3	5	mV
	Full	-	2	6	-	-	7	-	-	7	mV
Average Offset Voltage Drift	Full	-	5	-	-	5	-	-	5	-	$\mu V/°C$
Bias Current	25	-	1	15	-	5	25	-	5	25	nA
	Full	-	10	35	-	-	60	-	-	40	nA
Offset Current	25	-	1	15	-	5	25	-	5	25	nA
	Full	-	5	35	-	-	60	-	-	40	nA
Differential Input Resistance (Note 2)	25	65	500	-	40	300	-	40	300	-	M Ω
Input Noise Voltage Density (f = 1kHz)	25	-	11	-	-	11	-	-	11	-	nV/ \sqrt{Hz}
Input Noise Current Density (f = 1kHz)	25	-	0.16	-	-	0.16	-	-	0.16	-	pA/ \sqrt{Hz}
Common Mode Range	Full	± 11	± 12	-	± 11	± 12	-	± 11	± 12	-	V
TRANSFER CHARACTERISTICS											
Large Signal Voltage Gain (Notes 4, 5)	25	100	150	-	80	150	-	80	150	-	kV/V
	Full	70	-	-	60	-	-	70	-	-	kV/V
Common Mode Rejection Ratio (Note 6)	Full	80	100	-	74	100	-	74	100	-	dB
Minimum Stable Gain	25	5	-	-	5	-	-	5	-	-	V/V
Gain Bandwidth Product (Notes 4, 7, 8)	25	-	100	-	-	100	-	-	100	-	MHz
OUTPUT CHARACTERISTICS											
Output Voltage Swing (Note 4)	Full	± 10	± 12	-	± 10	± 12	-	± 10	± 12	-	V
Output Current (Note 5)	25	± 15	± 22	-	± 10	± 18	-	± 10	± 18	-	mA
Full Power Bandwidth (Notes 4, 5, 9, 13)	25	400	600	-	320	600	-	320	600	-	kHz
TRANSIENT RESPONSE (Note 8)											
Rise Time (Notes 4, 9, 10)	25	-	17	45	-	17	45	-	17	45	ns

3

OPERATIONAL AMPLIFIERS

HA-2620, HA-2622, HA-2625

Electrical Specifications $V_{SUPPLY} = \pm 15V$, Unless Otherwise Specified (Continued)

PARAMETER	TEMP. (°C)	HA-2620-2			HA-2622-2			HA-2625-5, -9			UNITS
		MIN	TYP	MAX	MIN	TYP	MAX	MIN	TYP	MAX	
Slew Rate (Notes 4, 9, 10, 12)	25	±25	±35	-	±20	±35	-	±20	±35	-	V/μs
POWER SUPPLY CHARACTERISTICS											
Supply Current	25	-	3	3.7	-	3	4	-	3	4	mA
Power Supply Rejection Ratio (Note 11)	Full	80	90	-	74	90	-	74	90	-	dB

NOTES:

2. This parameter value guaranteed by design calculations.
3. Offset may be externally adjusted to zero
4. $R_L = 2k\Omega$.
5. $V_{OUT} = \pm 10V$.
6. $V_{CM} = \pm 10V$.
7. $V_{OUT} < 90mV$.
8. 40dB Gain.
9. See Transient Response Test Circuits and Waveforms.
10. $A_V = 5$ (The HA-2620 family is not stable at unity gain without external compensation).
11. $\Delta V_S = \pm 5V$.
12. $V_{OUT} = \pm 5V$.
13. Full Power Bandwidth guaranteed by slew rate measurement: $FPBW = \frac{\text{Slew Rate}}{2\pi V_{PEAK}}$

Test Circuits and Waveforms

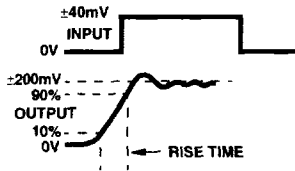

TRANSIENT RESPONSE

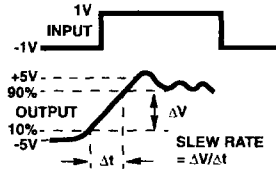

SLEW RATE

NOTE: Measured on both positive and negative transistions from $0V$ to $+200mV$ and $0V$ to $-200mV$ at output.

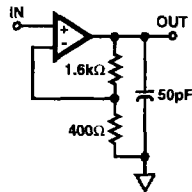

SLEW RATE AND TRANSIENT RESPONSE

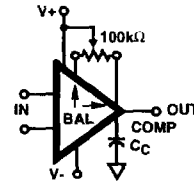

NOTE: Tested Offset Adjustment is $|V_{OS} + 1mV|$ minimum referred to output. Typical range is $\pm 10mV$ with $R_T = 100k\Omega$.

SUGGESTED V_{OS} ADJUSTMENT AND COMPENSATION HOOK-UP

Schematic Diagram

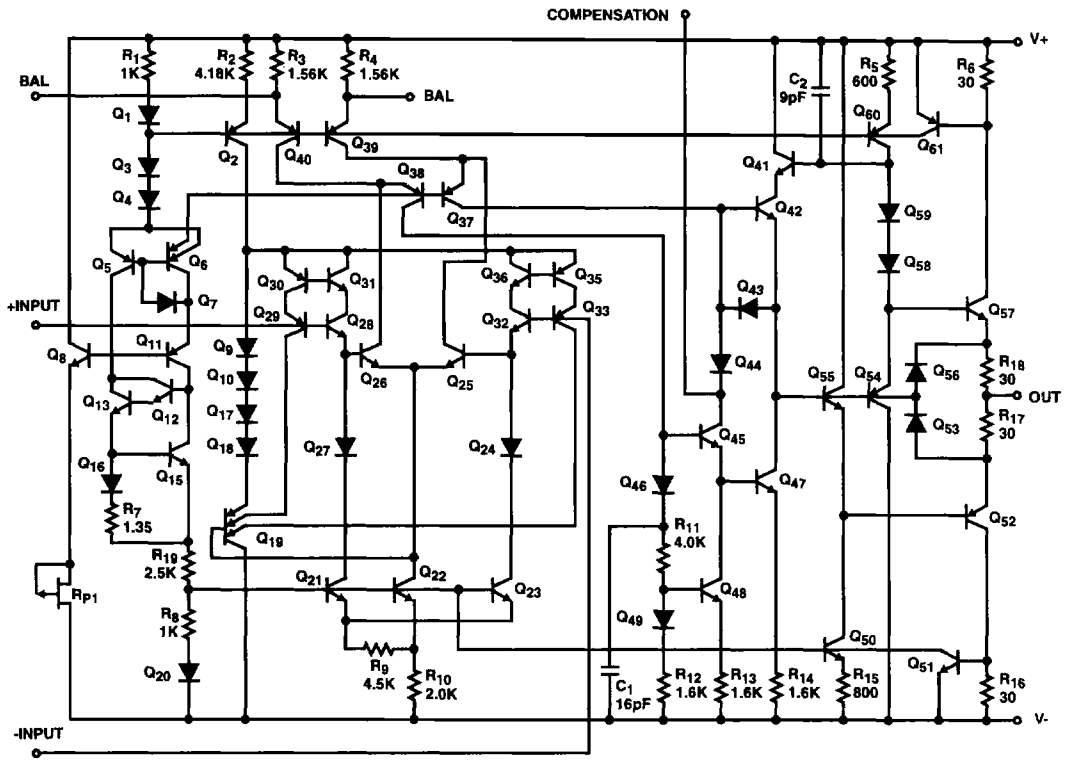

3
OPERATIONAL AMPLIFIERS

Typical Applications

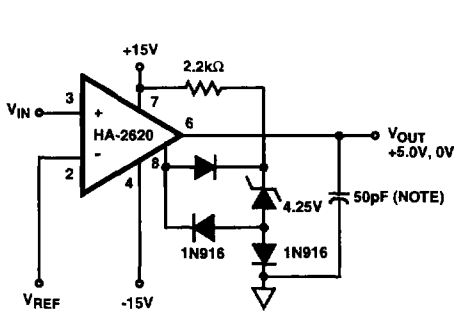

FIGURE 1. HIGH INPUT IMPEDANCE COMPARATOR

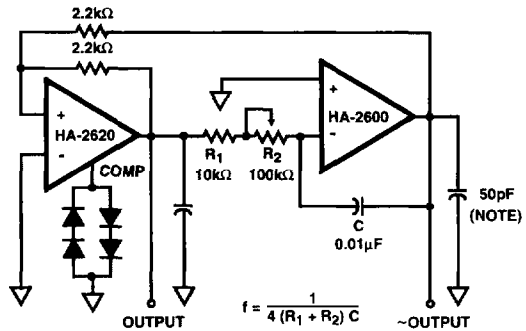
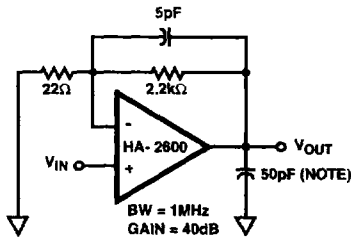

FIGURE 2. FUNCTION GENERATOR

Typical Applications (Continued)



NOTE: A small load capacitance of at least 30pF (including stray capacitance) is recommended to prevent possible high frequency oscillations.

FIGURE 3. VIDEO AMPLIFIER

Typical Performance Curves $V_S = \pm 15V, T_A = 25^\circ C$, Unless Otherwise Specified

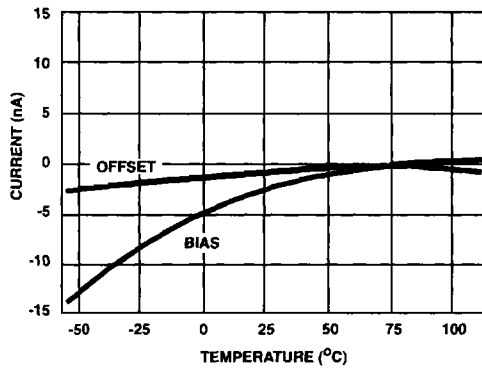

FIGURE 4. INPUT BIAS CURRENT AND OFFSET CURRENT vs TEMPERATURE

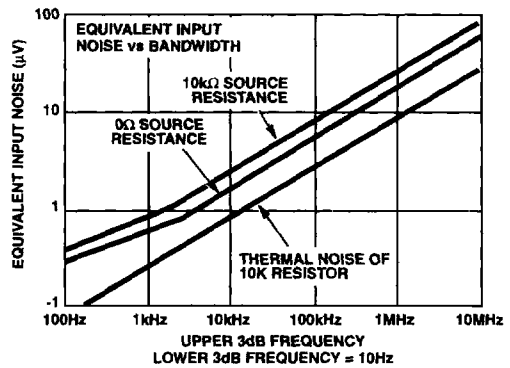

FIGURE 5. BROADBAND NOISE CHARACTERISTICS

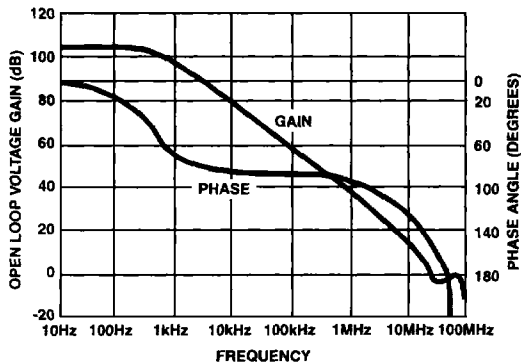

FIGURE 6. OPEN LOOP FREQUENCY RESPONSE

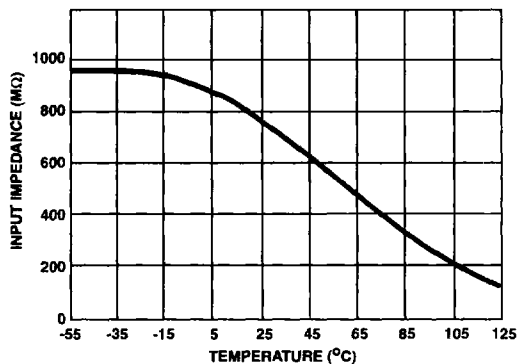

FIGURE 7. INPUT IMPEDANCE vs TEMPERATURE, 100Hz

Typical Performance Curves $V_S = \pm 15V$, $T_A = 25^\circ C$, Unless Otherwise Specified (Continued)

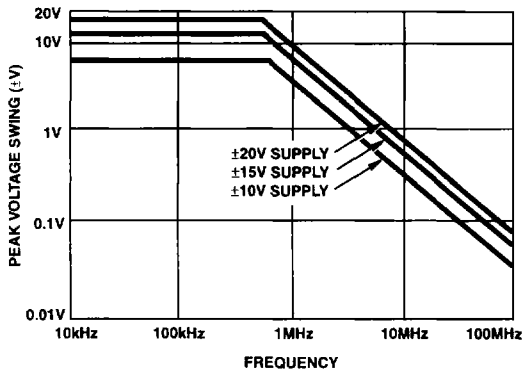
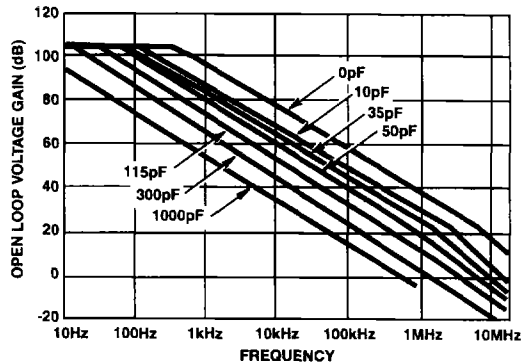

FIGURE 8. OUTPUT VOLTAGE SWING vs FREQUENCY



NOTE: External Compensation is required for closed loop gain < 5. If external compensation is used, also connect 100pF capacitor from output to ground.

FIGURE 9. OPEN LOOP FREQUENCY RESPONSE FOR VARIOUS VALUES OF CAPACITORS FROM COMP. PIN TO GND

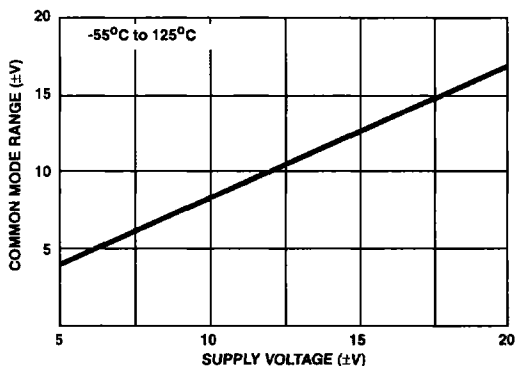

FIGURE 10. COMMON MODE VOLTAGE RANGE vs SUPPLY VOLTAGE

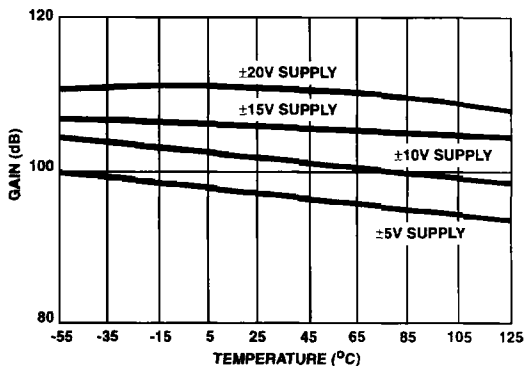

FIGURE 11. OPEN LOOP VOLTAGE GAIN vs TEMPERATURE

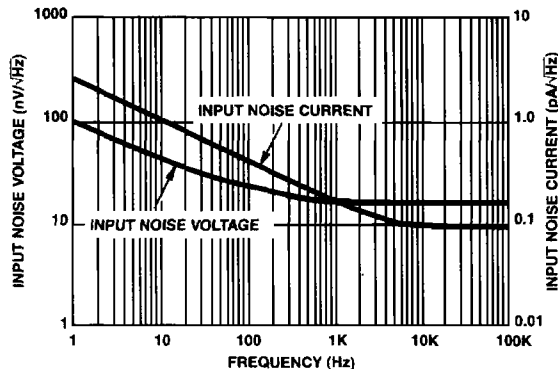

FIGURE 12. NOISE DENSITY vs FREQUENCY

HA-2620, HA-2622, HA-2625

Die Characteristics

DIE DIMENSIONS:

69 mils x 56 mils x 19 mils
1750 μ m x 1420 μ m x 483 μ m

METALLIZATION:

Type: Al, 1% Cu
Thickness: 16k \AA \pm 2k \AA

SUBSTRATE POTENTIAL (Powered Up)

Unbiased

PASSIVATION:

Type: Nitride (Si_3N_4) over Silox (SiO_2 , 5% Phos.)
Silox Thickness: 12k \AA \pm 2k \AA
Nitride Thickness: 3.5k \AA \pm 1.5k \AA

TRANSISTOR COUNT:

140

PROCESS:

Bipolar Dielectric Isolation

Metallization Mask Layout

HA-2620, HA-2622, HA-2625

