

High Slew Rate Operational Amplifier

March 1993

Features

- Unity Gain Bandwidth 300MHz
- Full Power Bandwidth 22MHz
- High Slew Rate 420V/ μ s
- High Output Drive \pm 50mA
- Monolithic Bipolar Construction

Applications

- RF/IF Processors
- Video Amplifiers
- Radar Systems
- Pulse Amplifiers
- High Speed Communications
- Fast Data Acquisition Systems

Description

The HFA-0005 is an all bipolar op amp featuring high slew rate (420V/ μ s), and high unity gain bandwidth (300MHz). These features combined with fast settling time (20ns) make this product very useful in high speed data acquisition systems as well as RF, video, and pulse amplifier designs.

Other outstanding characteristics include low bias currents (15 μ A), low offset current (6 μ A), and low offset voltage (6mV). These high performance characteristics are achieved with only 40mA of supply current.

The HFA-0005 offers high performance at low cost. It can replace hybrids and RF transistor amplifiers, simplifying designs while providing increased reliability due to monolithic construction. To enhance the ease of design, the HFA-0005 has a 50 Ω \pm 20% resistor connected from the output of the op amp to a separate pin. This can be used when driving 50 Ω strip line, microstrip, or coax cable.

For MIL-STD-883 compliant product consult the HFA-0005/883 datasheet.

Ordering Information

PART NUMBER	TEMPERATURE RANGE	PACKAGE
HFA2-0005-5	0°C to +75°C	8 Pin Can
HFA2-0005-9	-40°C to +85°C	8 Pin Can
HFA3-0005-5	0°C to +75°C	8 Lead Plastic DIP
HFA3-0005-9	-40°C to +85°C	8 Lead Plastic DIP
HFA7-0005-5	0°C to +75°C	8 Lead Ceramic Sidebrazed DIP
HFA7-0005-9	-40°C to +85°C	8 Lead Ceramic Sidebrazed DIP
HFA9P0005-5	0°C to +75°C	8 Lead SOIC
HFA9P0005-9	-40°C to +85°C	8 Lead SOIC

Pinouts

HFA-0005 (PDIP, CDIP, SOIC)
TOP VIEW

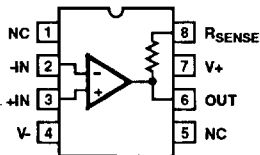

HFA-0005 (TO-99 METAL CAN)
TOP VIEW

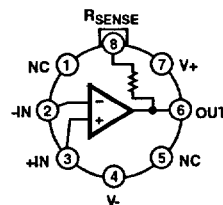

CAUTION: These devices are sensitive to electrostatic discharge. Users should follow proper I.C. Handling Procedures.
Copyright © Harris Corporation 1993

2-617

File Number 2918.1

Specifications HFA-0005

Absolute Maximum Ratings (Note 1)

Voltage Between V+ and V- Terminals	12V
Differential Input Voltage	5V
Input Voltage	±4V
Output Current	±60mA
Junction Temperature	+175°C
Junction Temperature (Plastic Packages)	+150°C
Lead Temperature (Soldering 10 Sec.)	300°C

Operating Conditions

Operating Temperature Range	-40°C ≤ T _A ≤ +85°C
HFA-0005-9	-40°C ≤ T _A ≤ +85°C
HFA-0005-5	0°C ≤ T _A ≤ +75°C
Storage Temperature Range	-65°C ≤ T _A ≤ +150°C

CAUTION: Stresses above those listed in "Absolute Maximum Ratings" may cause permanent damage to the device. This is a stress only rating and operation of the device at these or any other conditions above those indicated in the operational sections of this specification is not implied.

Electrical Specifications V+ = +5V, V- = -5V, Unless Otherwise Specified

PARAMETERS	TEMP	HFA-0005-9			HFA-0005-5			UNITS	
		MIN	TYP	MAX	MIN	TYP	MAX		
INPUT CHARACTERISTICS									
Offset Voltage	+25°C	-	6	15	-	6	30	mV	
	Full	-	11	45	-	11	35	mV	
Average Offset Voltage Drift	Full	-	100	-	-	100	-	μV/°C	
Bias Current	+25°C	-	15	50	-	15	100	μA	
	Full	-	20	50	-	20	100	μA	
Offset Current	+25°C	-	6	25	-	6	50	μA	
	Full	-	12	50	-	12	50	μA	
Common Mode Range	Full	±3	-	-	±3	-	-	V	
Differential Input Resistance	+25°C	-	10	-	-	10	-	kΩ	
Input Capacitance	+25°C	-	2	-	-	2	-	pF	
Input Noise Voltage	0.1Hz to 10Hz	+25°C	-	2.5	-	-	2.5	-	μV _{RMS}
	10Hz to 1MHz	+25°C	-	5.8	-	-	5.8	-	μV _{RMS}
Input Noise Voltage	f _o = 10Hz	+25°C	-	450	-	-	450	-	nV/√Hz
	f _o = 100Hz	+25°C	-	160	-	-	160	-	nV/√Hz
	f _o = 100kHz	+25°C	-	5	-	-	5	-	nV/√Hz
Input Noise Current	f _o = 10Hz	+25°C	-	2.0	-	-	2.0	-	nA/√Hz
	f _o = 100Hz	+25°C	-	0.57	-	-	0.57	-	nA/√Hz
	f _o = 1000Hz	+25°C	-	0.11	-	-	0.11	-	nA/√Hz
TRANSFER CHARACTERISTICS									
Large Signal Voltage Gain (Note 2)	+25°C	150	230	-	150	230	-	V/V	
	High	150	180	-	150	180	-	V/V	
	Low	150	250	-	150	250	-	V/V	
Common Mode Rejection Ratio (Note 3)	Full	45	47	-	42	45	-	dB	
Unity Gain Bandwidth	+25°C	-	300	-	-	300	-	MHz	
Minimum Stable Gain	Full	1	-	-	1	-	-	V/V	
OUTPUT CHARACTERISTICS									
Output Voltage Swing	R _L = 100Ω	+25°C	-	±3.5	-	-	±3.5	-	V
	R _L = 1kΩ	Full	±3.5	±4.0	-	±3.5	±4.0	-	V
Full Power Bandwidth (Note 5)	+25°C	-	22	-	-	22	-	MHz	
Output Resistance, Open Loop	+25°C	-	3.0	-	-	3.0	-	Ω	
Output Current	Full	±25	±50	-	±25	±50	-	mA	

Specifications HFA-0005

Electrical Specifications V+ = +5V, V- = -5V, Unless Otherwise Specified (Continued)

PARAMETERS	TEMP	HFA-0005-9			HFA-0005-5			UNITS
		MIN	TYP	MAX	MIN	TYP	MAX	
TRANSIENT RESPONSE								
Rise Time (Note 4, 6)	+25°C	-	480	-	-	480	-	ps
Slew Rate (Note 7)	+25°C	-	420	-	-	420	-	V/μs
Settling Time (3V Step) 0.1%	+25°C	-	20	-	-	20	-	ns
Overshoot (Note 4, 6)	+25°C	-	30	-	-	30	-	%
POWER SUPPLY CHARACTERISTICS								
Supply Current	+25°C	-	35	40	-	35	40	mA
	Full	-	37	40	-	37	45	mA
Power Supply Rejection Ratio (Note 8)	+25°C	40	42	-	37	40	-	dB

NOTES:

1. Absolute maximum ratings are limiting values, applied individually, beyond which the serviceability of the circuit may be impaired. Functional operation under any of these conditions is not necessarily implied.
2. $V_{OUT} = 0$ to $\pm 2V$, $R_L = 1k\Omega$.
3. $\Delta V_{CM} = \pm 2V$.
4. $R_L = 100\Omega$.
5. Full Power Bandwidth is calculated by equation: $FPBW = \frac{\text{Slew Rate}}{2\pi V_{PEAK}}$, $V_{PEAK} = 3.0V$.
6. $V_{OUT} = \pm 200mV$, $A_V = +1$.
7. $V_{OUT} = \pm 3V$, $A_V = +1$.
8. $\Delta V_S = \pm 4V$ to $\pm 6V$.
9. See Thermal Constants in "Applications Information" section. Maximum power dissipation, including output load, must be designed to maintain the junction temperature below +175°C for hermetic packages, and below +150°C for plastic packages.

Simplified Schematic Diagram

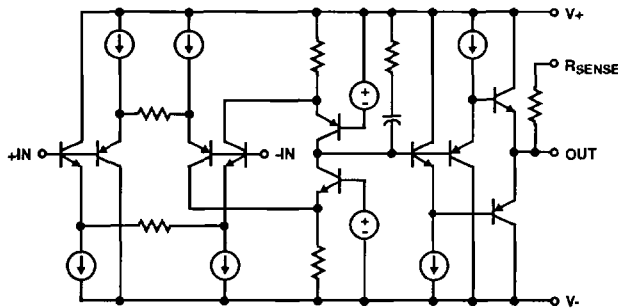

Die Characteristics

Thermal Constants (°C/W)	θ_{JA}	θ_{JC}
CAN	120	37
PDIP	98	36
CDIP	75	13
SOIC	158	43

Test Circuits

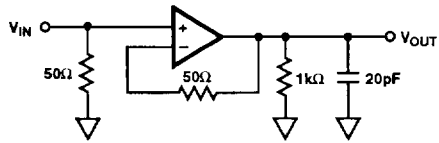

FIGURE 1. LARGE SIGNAL RESPONSE TEST CIRCUIT

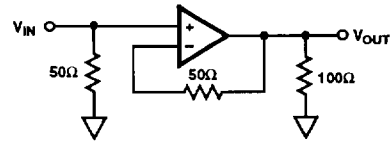
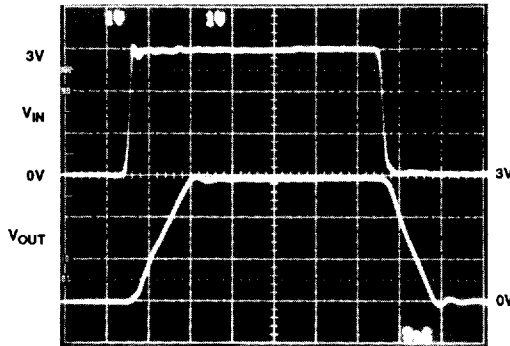

FIGURE 2. SMALL SIGNAL RESPONSE TEST CIRCUIT

LARGE SIGNAL RESPONSE

$V_{OUT} = 0$ to $3V$
Vertical Scale: $1V/Div$. Horizontal Scale: $5ns/Div$.



SMALL SIGNAL RESPONSE

$V_{OUT} = 0$ to $200mV$
Vertical Scale: $100mV/Div$. Horizontal Scale: $2ns/Div$.

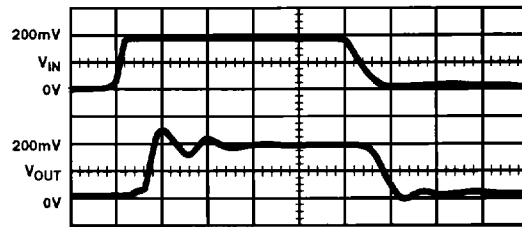

NOTE: Initial step in output is due to fixture feedthrough

PROPAGATION DELAY

Vertical Scale: $500mV/Div$. Horizontal Scale: $5ns/Div$.
 $A_V = +1$, $R_L = 1k\Omega$, $V_{OUT} = 0$ to $3V$

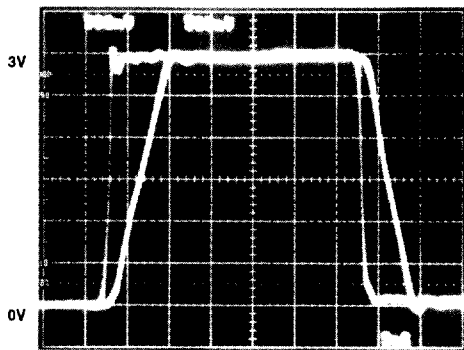

NOTE: Test fixture delay of $450ps$ is included

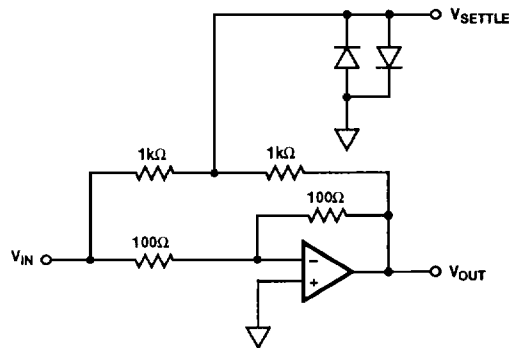

FIGURE 3. SETTLING TIME SCHEMATIC

Typical Performance Curves $V_S = \pm 5V, T_A = +25^\circ C$, Unless Otherwise Specified

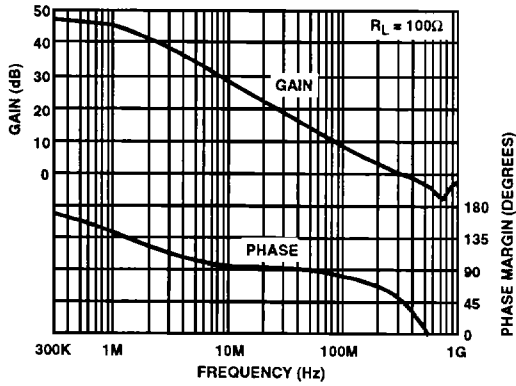

FIGURE 4. OPEN LOOP GAIN AND PHASE vs FREQUENCY

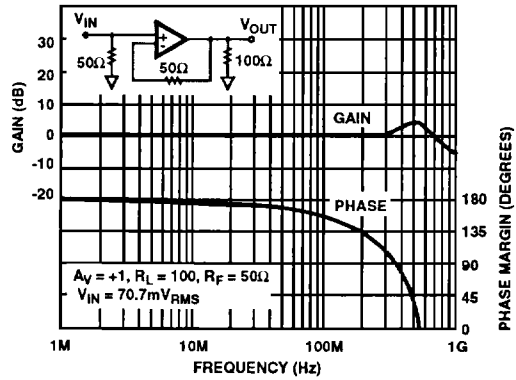

FIGURE 5. CLOSED LOOP GAIN vs FREQUENCY

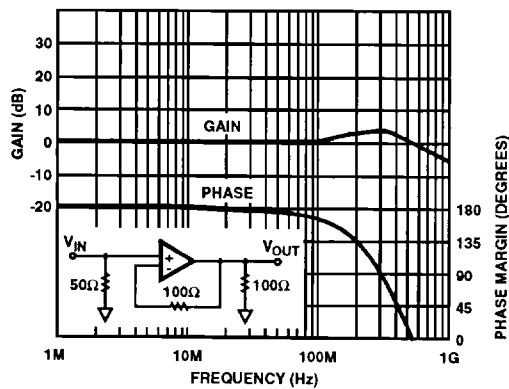

FIGURE 6. CLOSED LOOP GAIN vs FREQUENCY

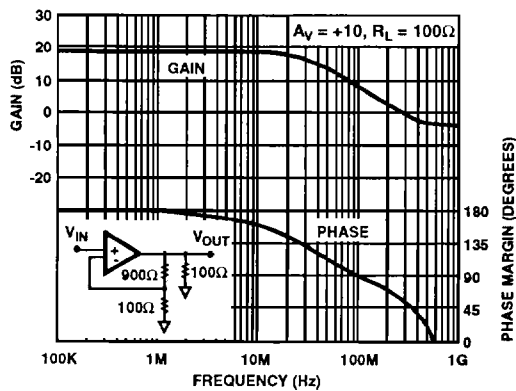

FIGURE 7. CLOSED LOOP GAIN vs FREQUENCY

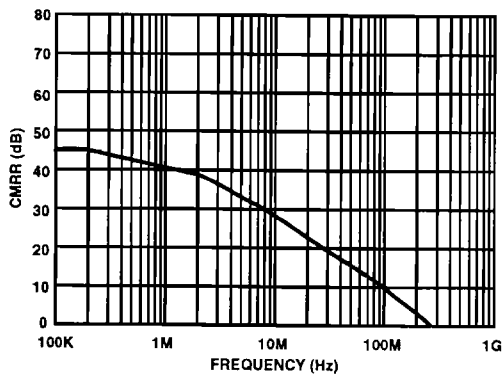

FIGURE 8. CMRR vs FREQUENCY

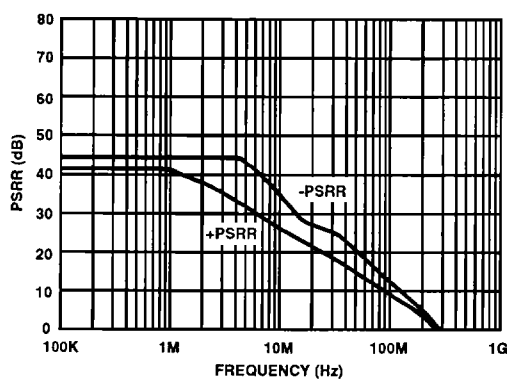

FIGURE 9. PSRR vs FREQUENCY

Typical Performance Curves $V_S = \pm 5V, T_A = +25^\circ C$, Unless Otherwise Specified (Continued)

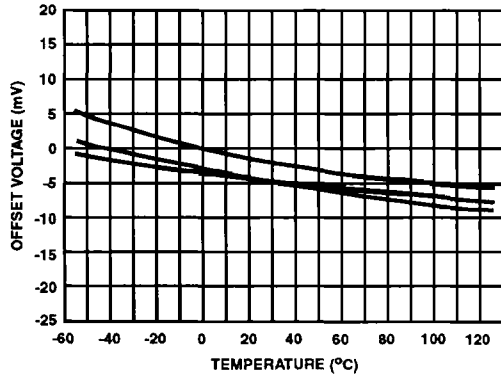

FIGURE 10. OFFSET VOLTAGE vs TEMPERATURE (3 REPRESENTATIVE UNITS)

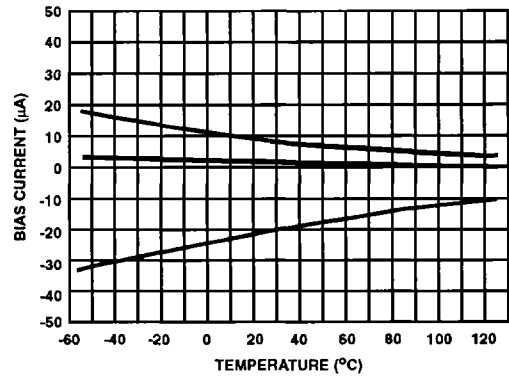

FIGURE 11. BIAS CURRENT vs TEMPERATURE (3 REPRESENTATIVE UNITS)

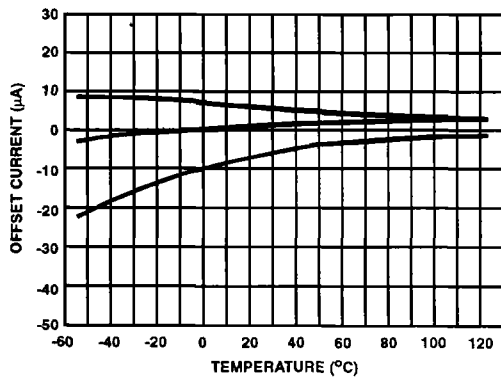

FIGURE 12. OFFSET CURRENT vs TEMPERATURE (3 REPRESENTATIVE UNITS)

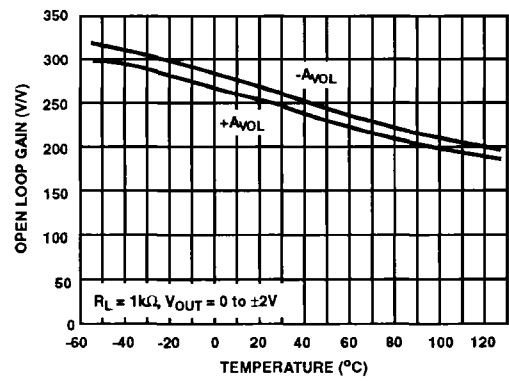

FIGURE 13. OPEN LOOP GAIN vs TEMPERATURE

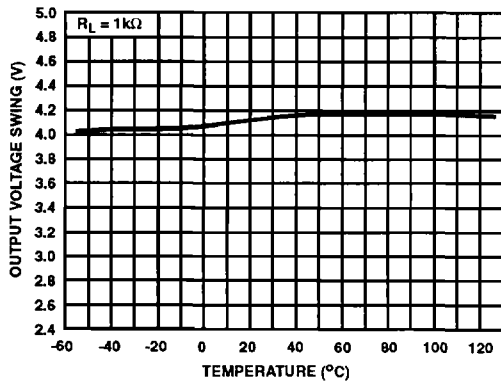

FIGURE 14. OUTPUT VOLTAGE SWING vs TEMPERATURE

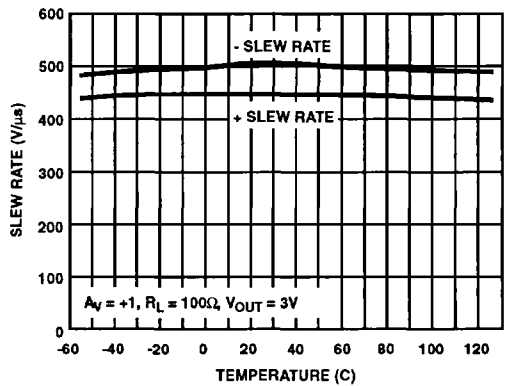

FIGURE 15. SLEW RATE vs TEMPERATURE

Typical Performance Curves $V_S = \pm 5V$, $T_A = +25^\circ C$, Unless Otherwise Specified (Continued)

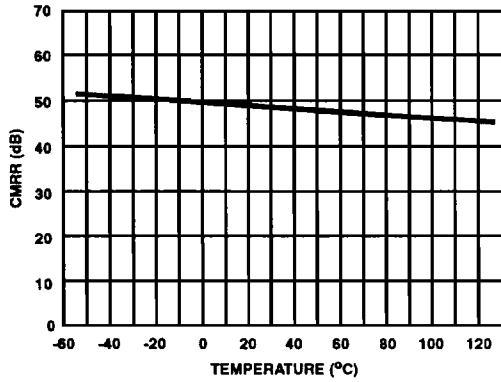

FIGURE 16. CMRR vs TEMPERATURE

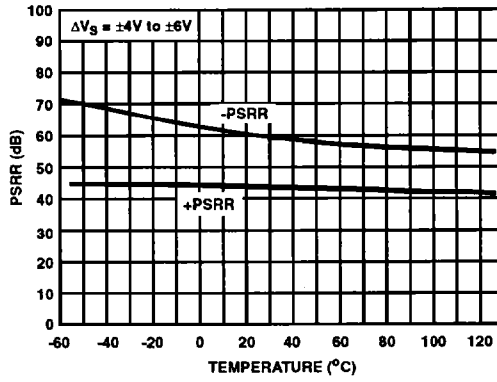

FIGURE 17. PSRR vs TEMPERATURE

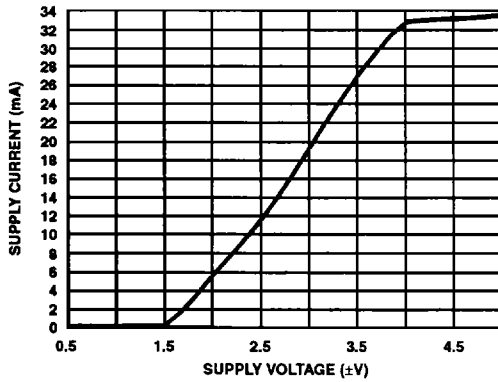

FIGURE 18. SUPPLY CURRENT vs SUPPLY VOLTAGE

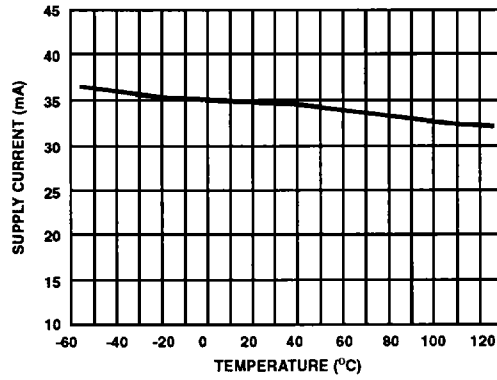

FIGURE 19. SUPPLY CURRENT vs TEMPERATURE

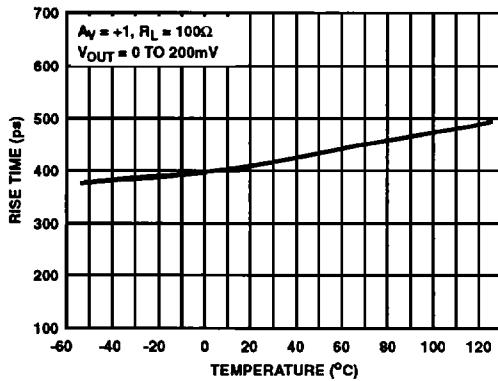

FIGURE 20. RISE TIME vs TEMPERATURE

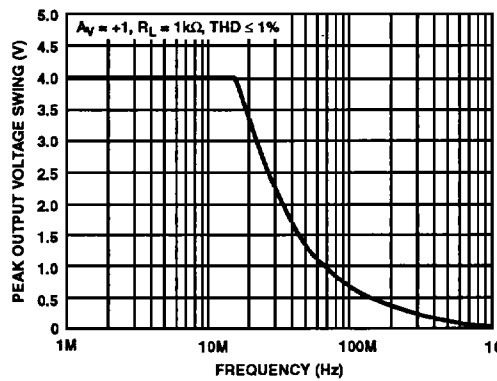

FIGURE 21. MAXIMUM OUTPUT VOLTAGE SWING vs FREQUENCY

Typical Performance Curves $V_S = \pm 5V$, $T_A = +25^\circ C$, Unless Otherwise Specified (Continued)

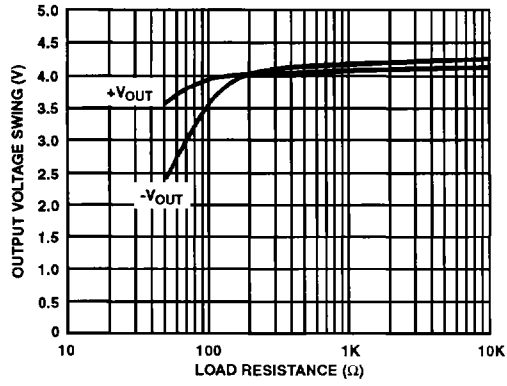

FIGURE 22. OUTPUT VOLTAGE SWING vs LOAD RESISTANCE

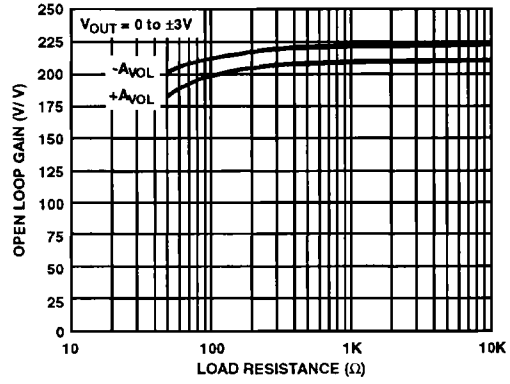

FIGURE 23. OPEN LOOP GAIN vs LOAD RESISTANCE

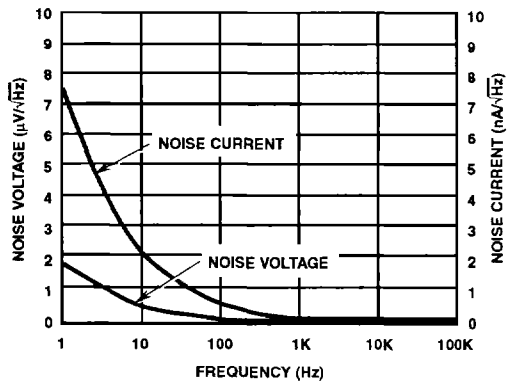

FIGURE 24. INPUT NOISE vs FREQUENCY

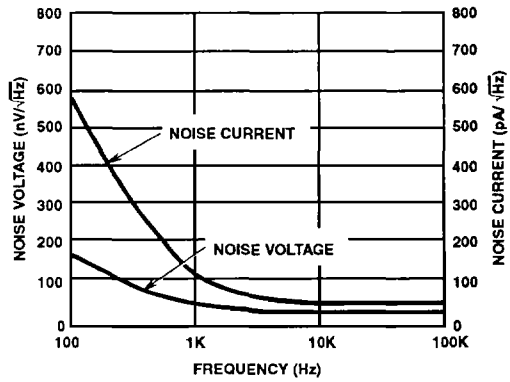

FIGURE 25. INPUT NOISE vs FREQUENCY

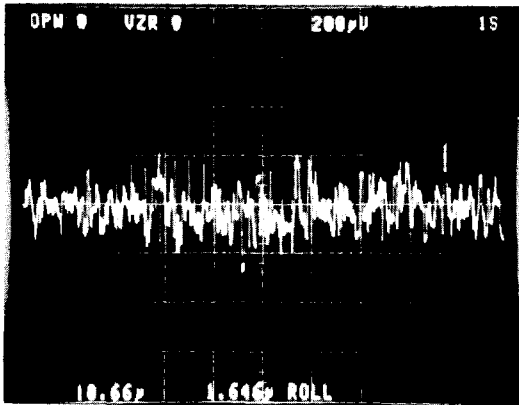

FIGURE 26. INPUT NOISE VOLTAGE
 $A_V = 50$, Noise Voltage = $1.646\mu V_{RMS}$ (RTI)

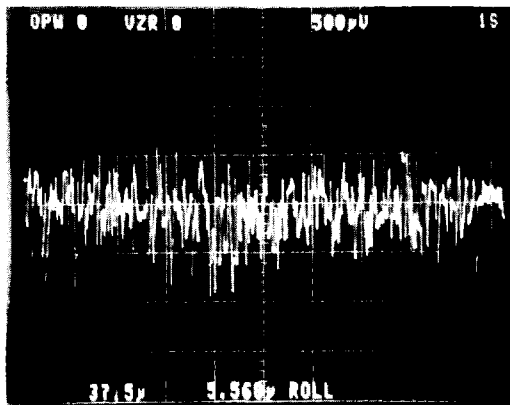

FIGURE 27. INPUT NOISE VOLTAGE
 $A_V = 50$, Noise Voltage = $5.568\mu V_{RMS}$ (RTI)

Applications Information

Offset Adjustment

When applications require the offset voltage to be as low as possible, the figure below shows two possible schemes for adjusting offset voltage.

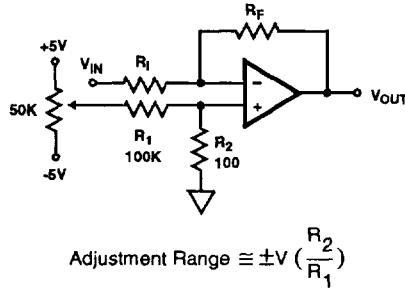

FIGURE 28. INVERTING GAIN

For a voltage follower application, use the circuit in Figure 29 without R_2 and with R_1 shorted. R_1 should then be $1M\Omega$ to $10M\Omega$, so the adjustment resistors will cause only a very small gain error.

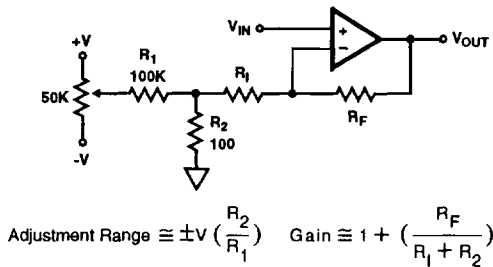

FIGURE 29. NON-INVERTING GAIN

PC Board Layout Guidelines

When designing with the HFA-0005, good high frequency (RF) techniques should be used when making a PC board. A massive ground plane should be used to maintain a low impedance ground. Proper shielding and use of short interconnection leads are also very important.

To achieve maximum high frequency performance, the use of low impedance transmission lines with impedance matching is recommended: 50Ω lines are common in communications and 75Ω lines in video systems. Impedance matching is important to minimize reflected energy therefore

minimizing transmitted signal distortion. This is accomplished by using a series matching resistor (50Ω or 75Ω), matched transmission line (50Ω or 75Ω), and a matched terminating resistor, as shown in Figure 30. Note that there will be a 6dB loss from input to output. The HFA-0005 has an integral $50\Omega \pm 20\%$ resistor connected to the op amp's output with the other end of the resistor pinned out. This 50Ω resistor can be used as the series resistor instead of an external resistor.

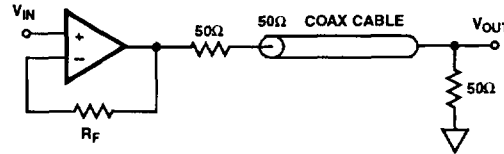

FIGURE 30.

PC board traces can be made to look like a 50Ω or 75Ω transmission line, called microstrip. Microstrip is a PC board trace with a ground plane directly beneath, on the opposite side of the board, as shown in Figure 31.

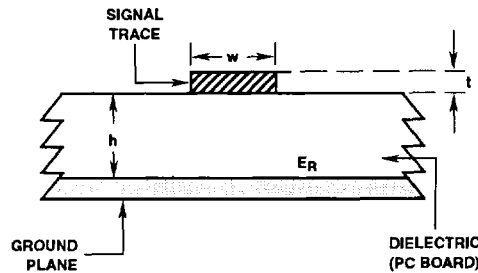

FIGURE 31.

When manufacturing pc boards the trace width can be calculated based on a number of variables.

The following equation is reasonably accurate for calculating the proper trace width for a 50Ω transmission line.

$$Z_0 = \frac{87}{\sqrt{E_R + 1.41}} \ln \left(\frac{5.98h}{0.8w + t} \right) \Omega$$

Power supply decoupling is essential for high frequency op amps. A $0.01\mu\text{F}$ high quality ceramic capacitor at each supply pin in parallel with a $1\mu\text{F}$ tantalum capacitor will provide excellent decoupling. Chip capacitors produce the best results due to ease of placement next to the op amp and they have negligible lead inductance. If leaded capacitors are used, the leads should be kept as short as possible to minimize lead inductance. The figures that follow illustrate two different decoupling schemes. Figure 33 improves the PSRR because the resistor and capacitors create low pass filters. Note that the supply current will create a voltage drop across the resistor.

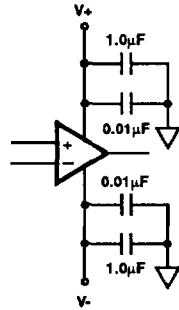

FIGURE 32.

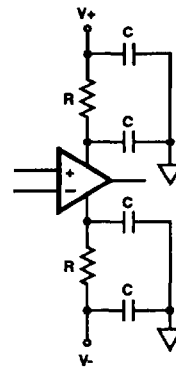

FIGURE 33.

Saturation Recovery

When an op amp is over driven output devices can saturate and sometimes take a long time to recover. By clamping the input to safe levels, output saturation can be avoided. If output saturation cannot be avoided, the recovery time from 25% overdrive is 20ns and 30ns from 50% overdrive.