

National Semiconductor is now part of
Texas Instruments.

Search <http://www.ti.com/> for the latest technical
information and details on our current products and services.

LMV341/LMV342/LMV344

Single with Shutdown/Dual/Quad General Purpose, 2.7V, Rail-to-Rail Output, 125°C, Operational Amplifiers

General Description

The LMV341/LMV342/LMV344 are single, dual, and quad low voltage, low power Operational Amplifiers. They are designed specifically for low voltage portable applications. Other important product characteristics are low input bias current, rail-to-rail output, and wide temperature range.

The patented class AB turnaround stage significantly reduces the noise at higher frequencies, power consumption, and off-set voltage. The PMOS input stage provides the user with ultra-low input bias current of 20fA (typical) and high input impedance.

The industrial-plus temperature range of -40°C to 125°C allows the LMV341/LMV342/LMV344 to accommodate a broad range of extended environment applications. LMV341 expands National Semiconductor's Silicon Dust™ amplifier portfolio offering enhancements in size, speed, and power savings. The LMV341/LMV342/LMV344 are guaranteed to operate over the voltage range of 2.7V to 5.5V and all have rail-to-rail output.

The LMV341 offers a shutdown pin that can be used to disable the device. Once in shutdown mode, the supply current is reduced to 45pA (typical). The LMV341/LMV342/LMV344 have 29nV Voltage Noise at 10KHz, 1MHz GBW, 1.0V/ μs Slew Rate, 0.25mVos, and 0.1 μA shutdown current (LMV341.)

The LMV341 is offered in the tiny 6-Pin SC70 package, the LMV342 in space saving 8-Pin MSOP and SOIC, and the LMV344 in 14-Pin TSSOP and SOIC. These small package amplifiers offer an ideal solution for applications requiring minimum PC board footprint. Applications with area con-

strained PC board requirements include portable electronics such as cellular handsets and PDAs.

Features

(Typical 2.7V supply values; unless otherwise noted)

| | |
|--|--------------------------|
| ■ Guaranteed 2.7V and 5V specifications | |
| ■ Input referred voltage noise (@ 10kHz) | 29nV/ $\sqrt{\text{Hz}}$ |
| ■ Supply current (per amplifier) | 100 μA |
| ■ Gain bandwidth product | 1.0MHz |
| ■ Slew rate | 1.0V/ μs |
| ■ Shutdown Current (LMV341) | 45pA |
| ■ Turn-on time from shutdown (LMV341) | 5 μs |
| ■ Input bias current | 20fA |

Applications

- Cordless/cellular phones
- Laptops
- PDAs
- PCMCIA/Audio
- Portable/battery-powered electronic equipment
- Supply current monitoring
- Battery monitoring
- Buffer
- Filter
- Driver

Sample and Hold Circuit

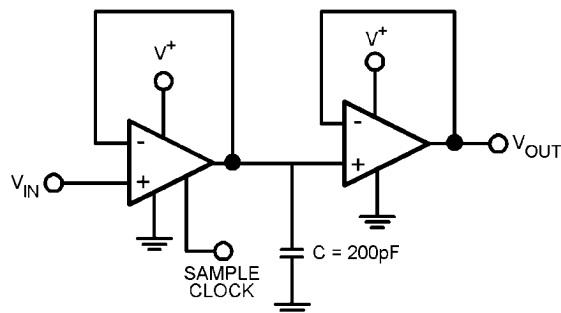

20030444

Absolute Maximum Ratings (Note 1)

If Military/Aerospace specified devices are required, please contact the National Semiconductor Sales Office/Distributors for availability and specifications.

| | |
|-------------------------------|------------------|
| ESD Tolerance (Note 2) | |
| Machine Model | 200V |
| Human Body Model | 2000V |
| Differential Input Voltage | ± Supply Voltage |
| Supply Voltage (V+ -V-) | 6.0V |
| Output Short Circuit to V+ | (Note 3) |
| Output Short Circuit to V- | (Note 4) |
| Storage Temperature Range | -65°C to 150°C |
| Junction Temperature (Note 5) | 150°C |
| Mounting Temperature | |

| | |
|--|-------|
| Infrared or Convection Reflow (20 sec.) | 235°C |
| Wave Soldering Lead Temp. (10 sec.) | 260°C |

Operating Ratings (Note 1)

| | |
|--------------------------------------|----------------|
| Supply Voltage | 2.7V to 5.5V |
| Temperature Range | -40°C to 125°C |
| Thermal Resistance (θ_{JA}) | |
| 6-Pin SC70 | 414°C/W |
| 8-Pin SOIC | 190°C/W |
| 8-Pin MSOP | 235°C/W |
| 14-Pin TSSOP | 155°C/W |
| 14-Pin SOIC | 145°C/W |

2.7V DC Electrical Characteristics (Note 10)

Unless otherwise specified, all limits guaranteed for $T_J = 25^\circ\text{C}$, $V^+ = 2.7\text{V}$, $V^- = 0\text{V}$, $V_{CM} = V^+/2$, $V_O = V^+/2$ and $R_L > 1\text{M}\Omega$. **Boldface** limits apply at the temperature extremes.

| Symbol | Parameter | Conditions | Min (Note 7) | Typ (Note 6) | Max (Note 7) | Units |
|------------|------------------------------------|---|-----------------|------------------------|---|------------------------------|
| V_{OS} | Input Offset Voltage | LMV341 | | 0.25 | 4 4.5 | mV |
| | | LMV342/LMV344 | | 0.55 | 5 5.5 | |
| TCV_{OS} | Input Offset Voltage Average Drift | | | 1.7 | | $\mu\text{V}/^\circ\text{C}$ |
| I_B | Input Bias Current | | | 0.02 | 120 250 | pA |
| I_{OS} | Input Offset Current | | | 6.6 | | fA |
| I_S | Supply Current | Per Amplifier | | 100 | 170 230 | μA |
| | | Shutdown Mode, $V_{SD} = 0\text{V}$ (LMV341) | | 45pA | 1 μA 1.5μA | |
| CMRR | Common Mode Rejection Ratio | $0\text{V} \leq V_{CM} \leq 1.7\text{V}$ | 56 | 80 | | dB |
| | | $0\text{V} \leq V_{CM} \leq 1.6\text{V}$ | 50 | | | |
| PSRR | Power Supply Rejection Ratio | $2.7\text{V} \leq V^+ \leq 5\text{V}$ | 65 60 | 82 | | dB |
| V_{CM} | Input Common Mode Voltage | For CMRR $\geq 50\text{dB}$ | 0 | -0.2 to 1.9 (Range) | 1.7 | V |
| A_V | Large Signal Voltage Gain | $R_L = 10\text{k}\Omega$ to 1.35V | 78 70 | 113 | | dB |
| | | $R_L = 2\text{k}\Omega$ to 1.35V | 72 64 | 103 | | |
| V_O | Output Swing | $R_L = 2\text{k}\Omega$ to 1.35V | | 24 | 60 95 | mV |
| | | | | 60 95 | 26 | |
| | | $R_L = 10\text{k}\Omega$ to 1.35V | | 5.0 | 30 40 | |
| | | | | 30 40 | 5.3 | |

| Symbol | Parameter | Conditions | Min (Note 7) | Typ (Note 6) | Max (Note 7) | Units |
|----------|------------------------------|---------------------------|-----------------|-----------------|-----------------|---------|
| I_O | Output Short Circuit Current | Sourcing LMV341/LMV342 | 20 | 32 | | mA |
| | | Sourcing LMV344 | 18 | 24 | | |
| | | Sinking | 15 | 24 | | |
| t_{on} | Turn-on Time from Shutdown | (LMV341) | | 5 | | μ s |
| V_{SD} | Shutdown Pin Voltage Range | ON Mode (LMV341) | | 1.7 to 2.7 | 2.4 to 2.7 | V |
| | | Shutdown Mode (LMV341) | | 0 to 1 | 0 to 0.8 | |

2.7V AC Electrical Characteristics (Note 10)

Unless otherwise specified, all limits guaranteed for $T_J = 25^\circ\text{C}$, $V^+ = 2.7\text{V}$, $V^- = 0\text{V}$, $V_{CM} = V^+/2$, $V_O = V^+/2$ and $R_L > 1\text{M}\Omega$.

Boldface limits apply at the temperature extremes.

| Symbol | Parameter | Conditions | Min (Note 7) | Typ (Note 6) | Max (Note 7) | Units |
|----------|------------------------------|---|-----------------|-----------------|-----------------|------------------------------|
| SR | Slew Rate | $R_L = 10\text{k}\Omega$, (Note 9) | | 1.0 | | V/ μ s |
| GBW | Gain Bandwidth Product | $R_L = 100\text{k}\Omega$, $C_L = 200\text{pF}$ | | 1.0 | | MHz |
| ϕ_m | Phase Margin | $R_L = 100\text{k}\Omega$ | | 72 | | deg |
| G_m | Gain Margin | $R_L = 100\text{k}\Omega$ | | 20 | | dB |
| e_n | Input-Referred Voltage Noise | $f = 1\text{kHz}$ | | 40 | | $\text{nV}/\sqrt{\text{Hz}}$ |
| i_n | Input-Referred Current Noise | $f = 1\text{kHz}$ | | 0.001 | | $\text{pA}/\sqrt{\text{Hz}}$ |
| THD | Total Harmonic Distortion | $f = 1\text{kHz}$, $A_V = +1$ $R_L = 600\Omega$, $V_{IN} = 1\text{V}_{PP}$ | | 0.017 | | % |

5V DC Electrical Characteristics (Note 10)

Unless otherwise specified, all limits guaranteed for $T_J = 25^\circ\text{C}$, $V^+ = 5\text{V}$, $V^- = 0\text{V}$, $V_{CM} = V^+/2$, $V_O = V^+/2$ and $R_L > 1\text{M}\Omega$. **Boldface** limits apply at the temperature extremes.

| Symbol | Parameter | Conditions | Min (Note 7) | Typ (Note 6) | Max (Note 7) | Units |
|------------|------------------------------------|---|-----------------|------------------------|-------------------|------------------------------|
| V_{OS} | Input Offset Voltage | LMV341 | | 0.025 | 4 4.5 | mV |
| | | LMV342/LMV344 | | 0.70 | 5 5.5 | |
| TCV_{OS} | Input Offset Voltage Average Drift | | | 1.9 | | $\mu\text{V}/^\circ\text{C}$ |
| I_B | Input Bias Current | | | 0.02 | 200 375 | pA |
| I_{OS} | Input Offset Current | | | 6.6 | | fA |
| I_S | Supply Current | Per Amplifier | | 107 | 200 260 | μ A |
| | | Shutdown Mode, $V_{SD} = 0\text{V}$ (LMV341) | | 0.033 | 1 1.5 | μ A |
| CMRR | Common Mode Rejection Ratio | $0\text{V} \leq V_{CM} \leq 4.0\text{V}$ | 56 | 86 | | dB |
| | | $0\text{V} \leq V_{CM} \leq 3.9\text{V}$ | 50 | | | |
| PSRR | Power Supply Rejection Ratio | $2.7\text{V} \leq V^+ \leq 5\text{V}$ | 65 | 82 | | dB |
| | | | 60 | | | |
| V_{CM} | Input Common Mode Voltage | For CMRR $\geq 50\text{dB}$ | 0 | -0.2 to 4.2 (Range) | 4 | V |

| Symbol | Parameter | Conditions | Min (Note 7) | Typ (Note 6) | Max (Note 7) | Units |
|----------|------------------------------------|---------------------------|-----------------|-----------------|-----------------|---------|
| A_V | Large Signal Voltage Gain (Note 8) | $R_L = 10k\Omega$ to 2.5V | 78 70 | 116 | | dB |
| | | $R_L = 2k\Omega$ to 2.5V | 72 64 | 107 | | |
| V_O | Output Swing | $R_L = 2k\Omega$ to 2.5V | | 32 | 60 95 | mV |
| | | | 60 95 | 34 | | |
| | | $R_L = 10k\Omega$ to 2.5V | | 7 | 30 40 | mV |
| | | | 30 40 | 7 | | |
| I_O | Output Short Circuit Current | Sourcing | 85 | 113 | | mA |
| | | Sinking | 50 | 75 | | |
| t_{on} | Turn-on Time from Shutdown | (LMV341) | | 5 | | μs |
| V_{SD} | Shutdown Pin Voltage Range | ON Mode (LMV341) | | 3.1 to 5 | 4.5 to 5.0 | V |
| | | Shutdown Mode (LMV341) | | 0 to 1 | 0 to 0.8 | |

5V AC Electrical Characteristics (Note 10)

Unless otherwise specified, all limits guaranteed for $T_J = 25^\circ C$, $V^+ = 5V$, $V^- = 0V$, $V_{CM} = V^+/2$, $V_O = V^+/2$ and $R_L > 1M\Omega$. **Bold-face** limits apply at the temperature extremes.

| Symbol | Parameter | Conditions | Min (Note 7) | Typ (Note 6) | Max (Note 7) | Units |
|----------|------------------------------|---|-----------------|-----------------|-----------------|----------------|
| SR | Slew Rate | $R_L = 10k\Omega$, (Note 9) | | 1.0 | | V/ μs |
| GBW | Gain-Bandwidth Product | $R_L = 10k\Omega$, $C_L = 200pF$ | | 1.0 | | MHz |
| Φ_m | Phase Margin | $R_L = 100k\Omega$ | | 70 | | deg |
| G_m | Gain Margin | $R_L = 100k\Omega$ | | 20 | | dB |
| e_n | Input-Referred Voltage Noise | $f = 1kHz$ | | 39 | | nV/\sqrt{Hz} |
| i_n | Input-Referred Current Noise | $f = 1kHz$ | | 0.001 | | pA/\sqrt{Hz} |
| THD | Total Harmonic Distortion | $f = 1kHz$, $A_V = +1$ $R_L = 600\Omega$, $V_{IN} = 1V_{PP}$ | | 0.012 | | % |

Note 1: Absolute Maximum Ratings indicate limits beyond which damage to the device may occur. Operating Ratings indicate conditions for which the device is intended to be functional, but specific performance is not guaranteed. For guaranteed specifications and the test conditions, see the Electrical Characteristics.

Note 2: Human Body Model, applicable std. MIL-STD-883, Method 3015.7. Machine Model, applicable std. JESD22-A115-A (ESD MM std. of JEDEC). Field-Induced Charge-Device Model, applicable std. JESD22-C101-C (ESD FICDM std. of JEDEC).

Note 3: Shorting output to V^+ will adversely affect reliability.

Note 4: Shorting output to V^- will adversely affect reliability.

Note 5: The maximum power dissipation is a function of $T_{J(MAX)}$, θ_{JA} . The maximum allowable power dissipation at any ambient temperature is $P_D = (T_{J(MAX)} - T_A) / \theta_{JA}$. All numbers apply for packages soldered directly onto a PC Board.

Note 6: Typical values represent the most likely parametric norm as determined at the time of characterization. Actual typical values may vary over time and will also depend on the application and configuration. The typical values are not tested and are not guaranteed on shipped production material.

Note 7: All limits are guaranteed by testing or statistical analysis.

Note 8: R_L is connected to mid-supply. The output voltage is $GND + 0.2V \leq V_O \leq V^+ - 0.2V$

Note 9: Connected as voltage follower with $2V_{PP}$ step input. Number specified is the slower of the positive and negative slew rates.

Note 10: Electrical Table values apply only for factory testing conditions at the temperature indicated. Factory testing conditions result in very limited self-heating of the device such that $T_J = T_A$. No guarantee of parametric performance is indicated in the electrical tables under conditions of internal self heating where $T_J > T_A$.

Connection Diagrams

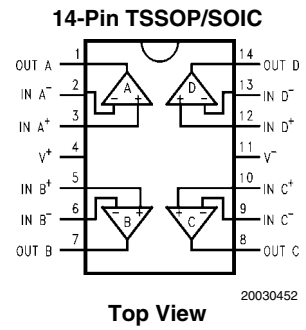
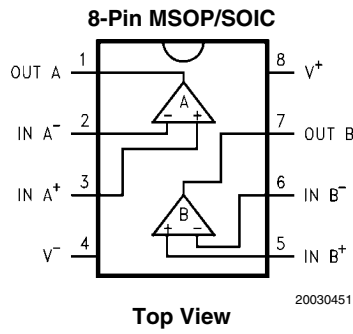
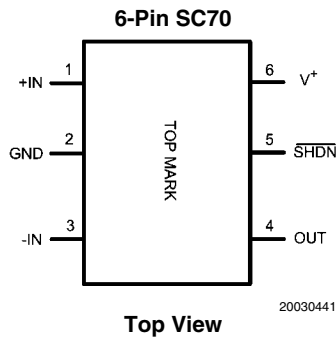

Ordering Information

| Package | Part Number | Package Marking | Transport Media | NSC Drawing |
|--------------|-------------|-----------------|--------------------------|-------------|
| 6-Pin SC70 | LMV341MG | A78 | 1k Units Tape and Reel | MAA06A |
| | LMV341MGX | | 3k Units Tape and Reel | |
| 8-Pin MSOP | LMV342MM | A82A | 1k Units Tape and Reel | MUA08A |
| | LMV342MMX | | 3.5k Units Tape and Reel | |
| 8-Pin SOIC | LMV342MA | LMV342MA | 95 Units/Rail | M08A |
| | LMV342MAX | | 2.5k Units Tape and Reel | |
| 14-Pin TSSOP | LMV344MT | LMV344MT | Rails | MTC14 |
| | LMV344MTX | | 2.5k Units Tape and Reel | |
| 14-Pin SOIC | LMV344MA | LMV344MA | 55 Units/Rail | M14A |
| | LMV344MAX | | 2.5k Units Tape and Reel | |

Typical Performance Characteristics

Supply Current vs. Supply Voltage (LMV341)

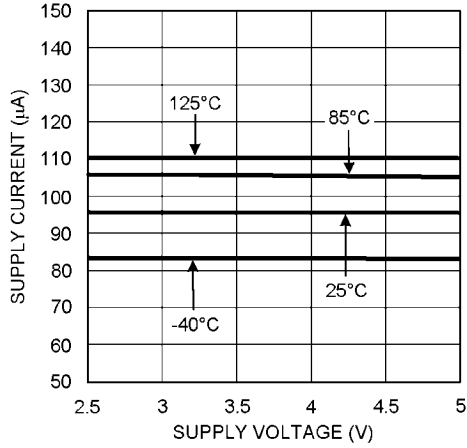

20030428

Input Current vs. Temperature

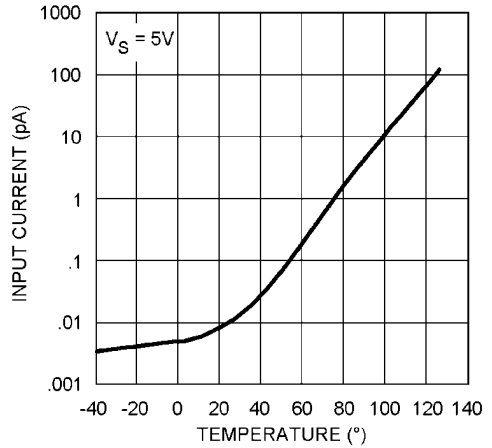

20030446

Output Voltage Swing vs. Supply Voltage

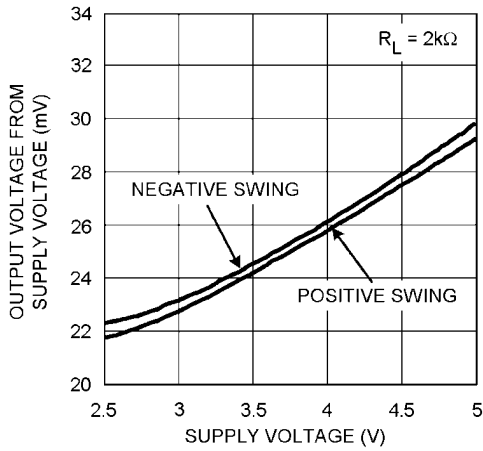

20030426

Output Voltage Swing vs. Supply Voltage

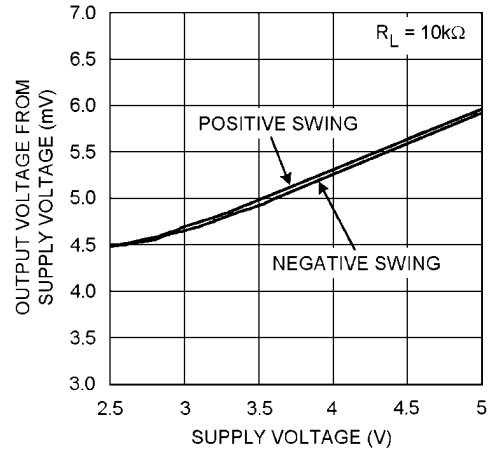

20030427

I_{SOURCE} vs. V_{OUT}

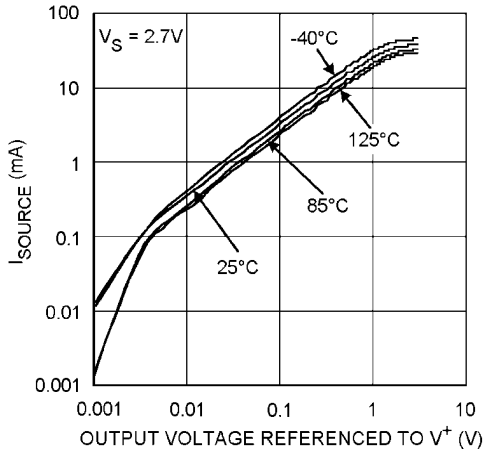

20030429

I_{SOURCE} vs. V_{OUT}

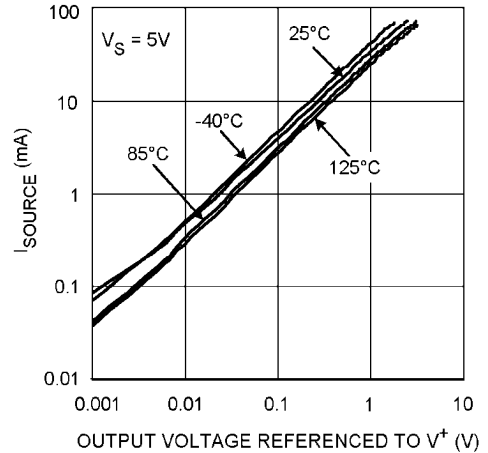

20030430

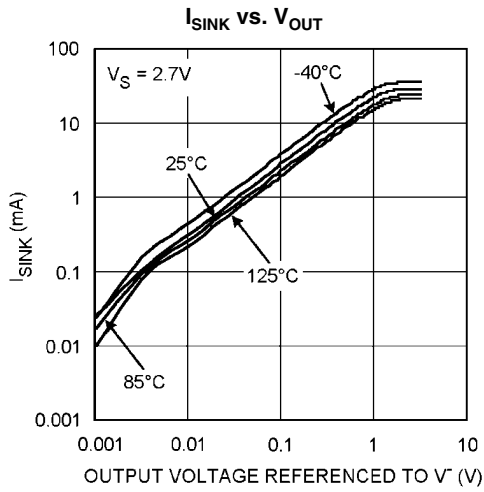

20030431

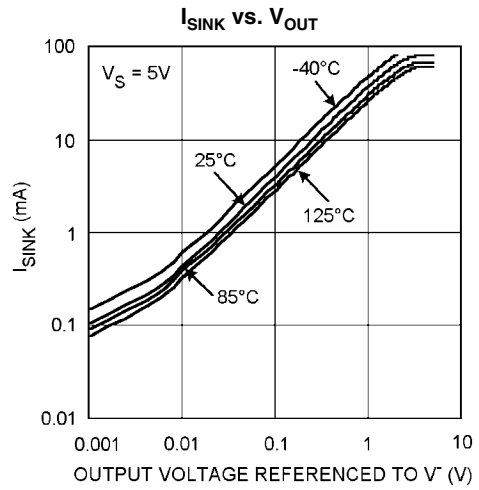

20030432

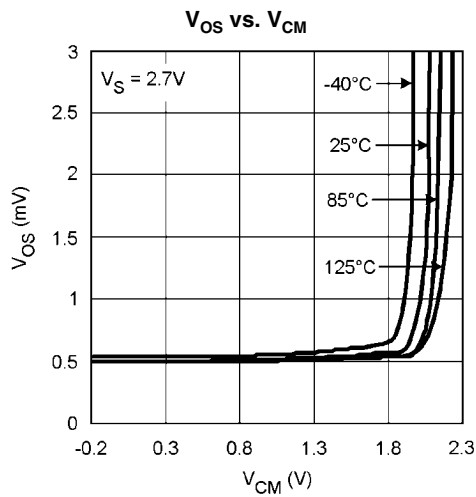

20030433

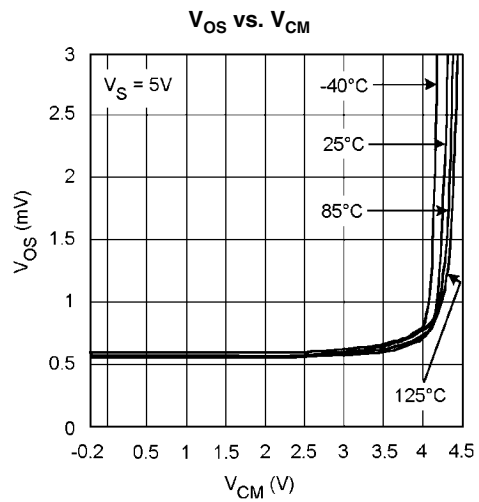

20030434

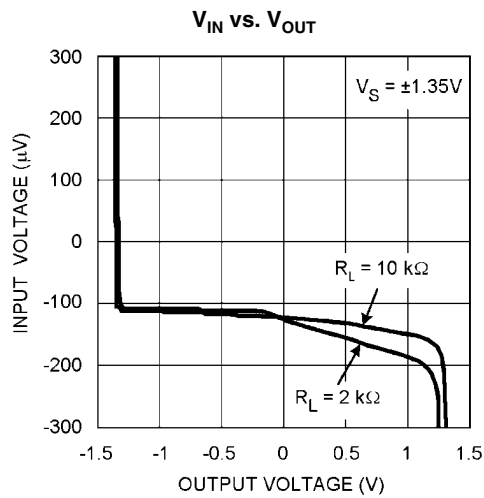

20030435

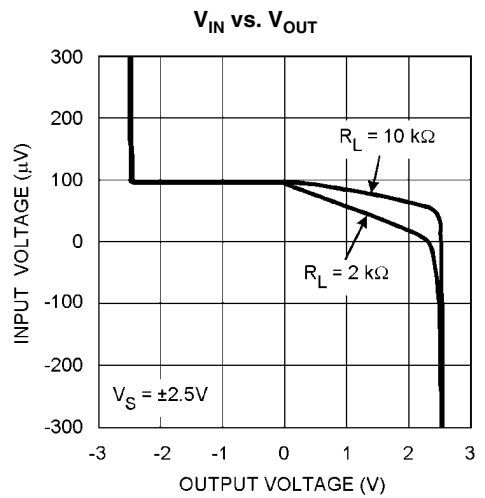

20030436

CMRR vs. Frequency

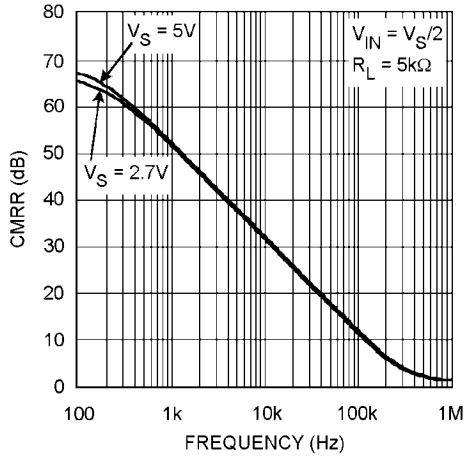

20030403

PSRR vs. Frequency

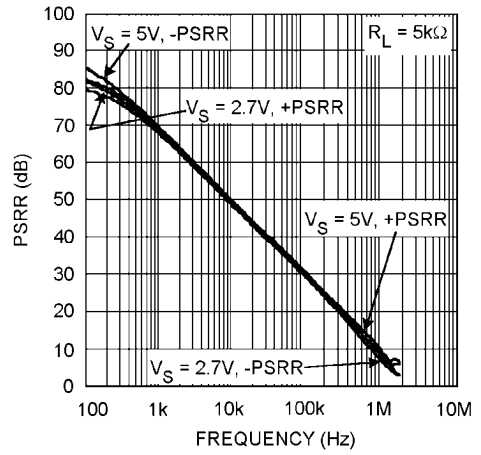

20030401

Input Voltage Noise vs. frequency

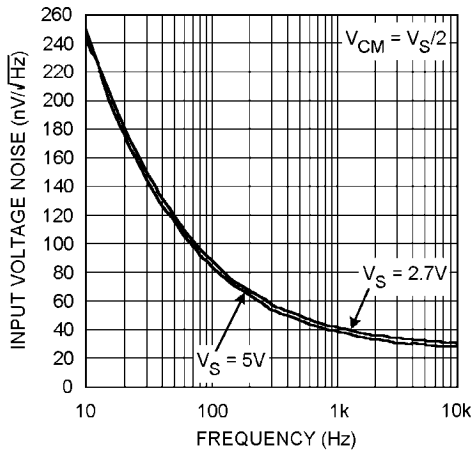

20030404

Slew Rate vs. V_{SUPPLY}

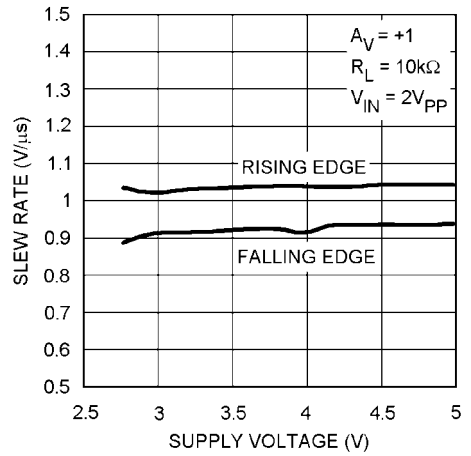

20030402

Slew Rate vs. Temperature

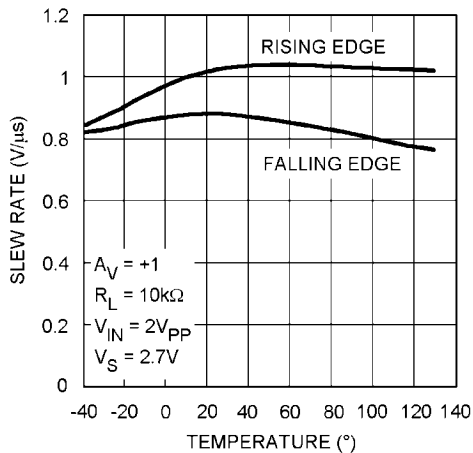

20030422

Slew Rate vs. Temperature

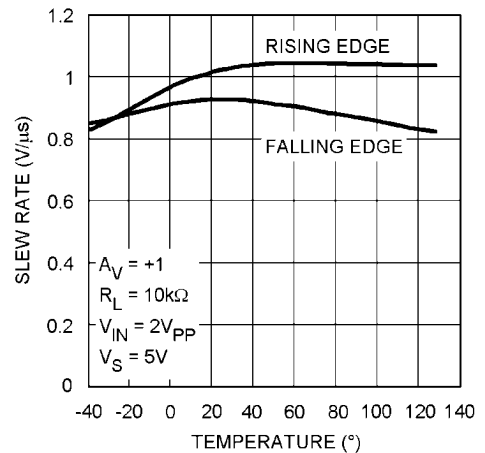

20030423

THD+N vs. Frequency

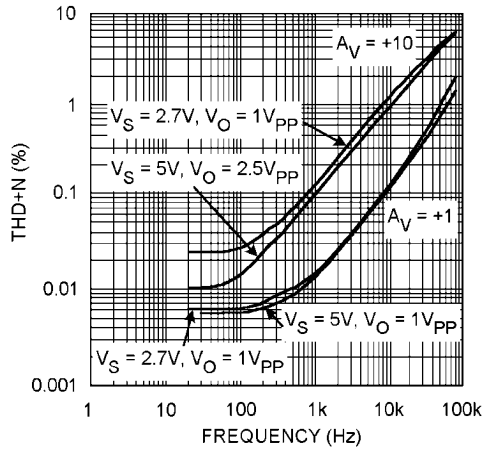

20030425

THD+N vs. V_{OUT}

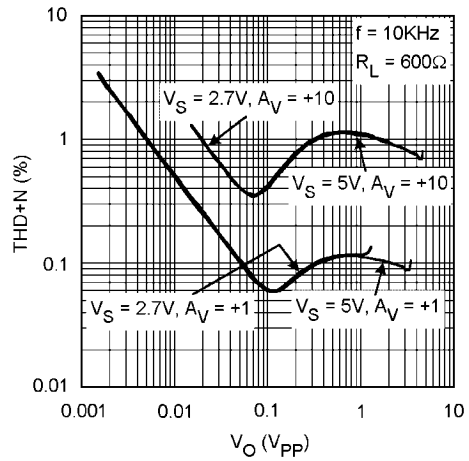

20030424

Open Loop Frequency Over Temperature

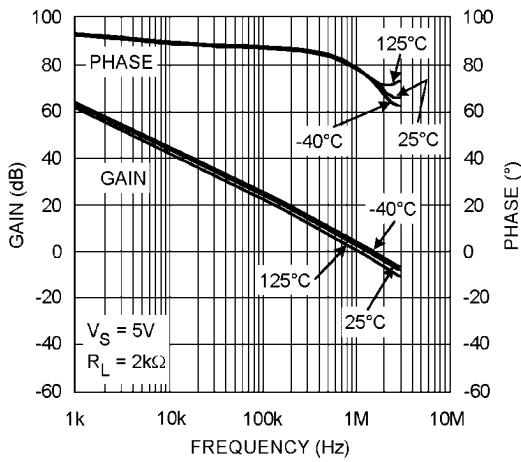

20030421

Open Loop Frequency Response

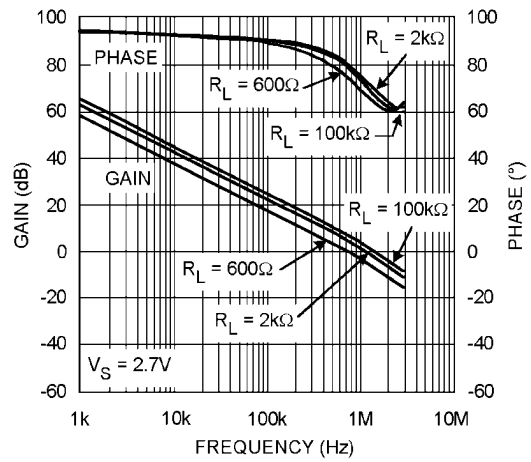

20030420

Open Loop Frequency Response

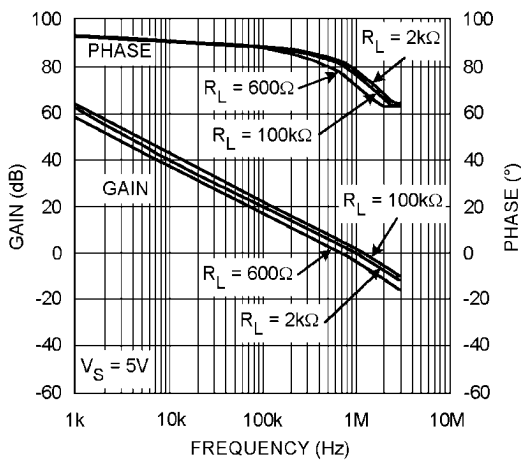

20030419

Gain and Phase vs. C_L

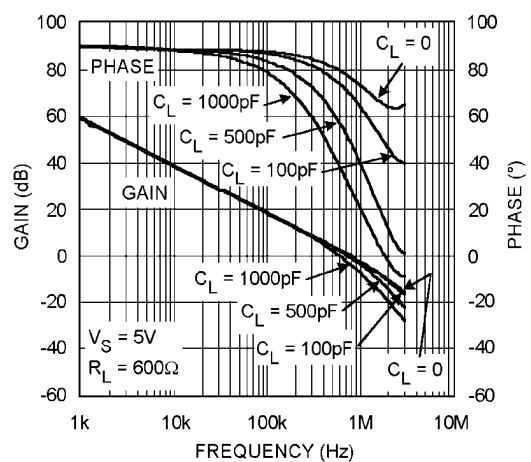

20030417

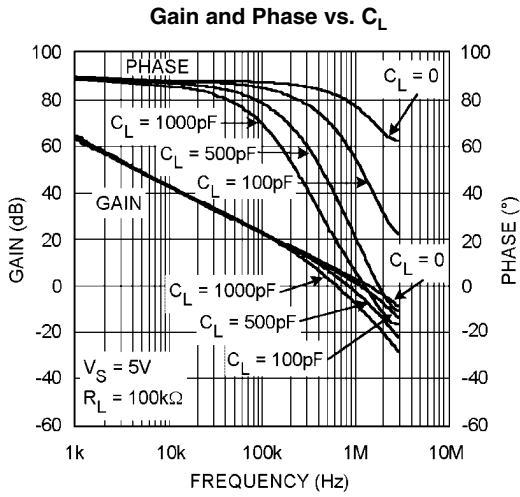

20030418

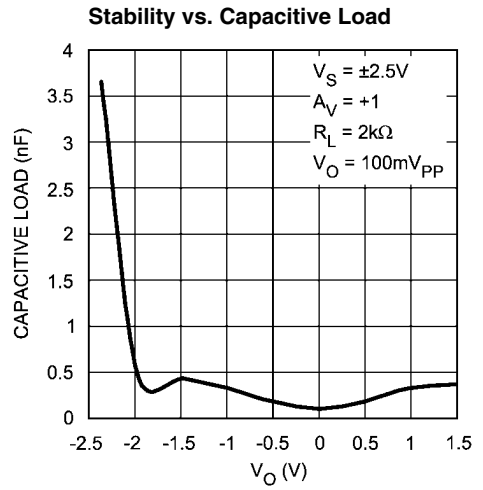

20030448

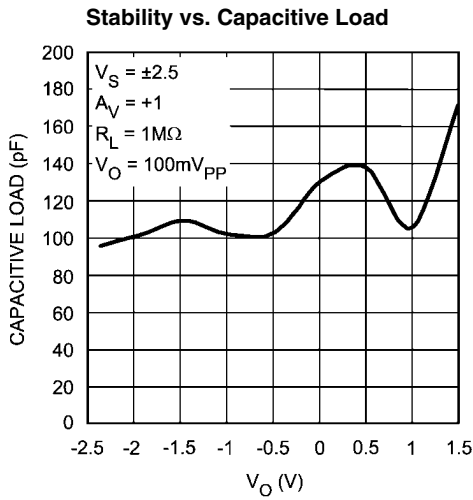

20030449

Non-Inverting Small Signal Pulse Response

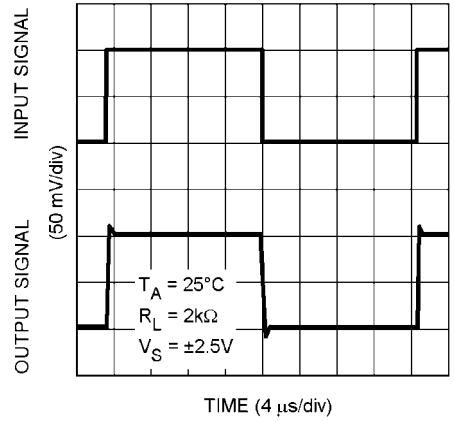

20030405

Non-Inverting Large Signal Pulse Response

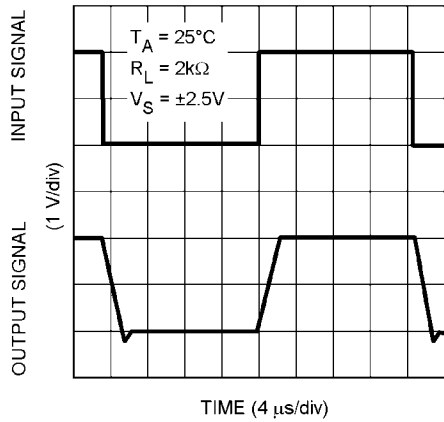

20030408

Non-Inverting Small Signal Pulse Response

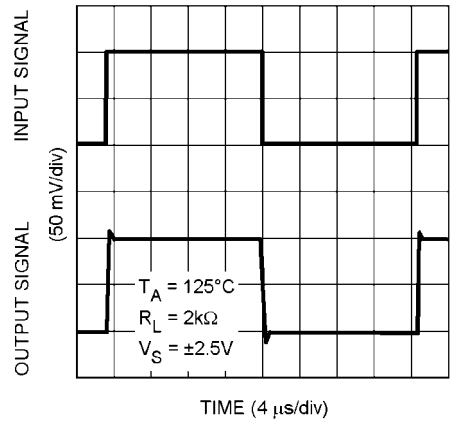

20030406

Non-Inverting Large Signal Pulse Response

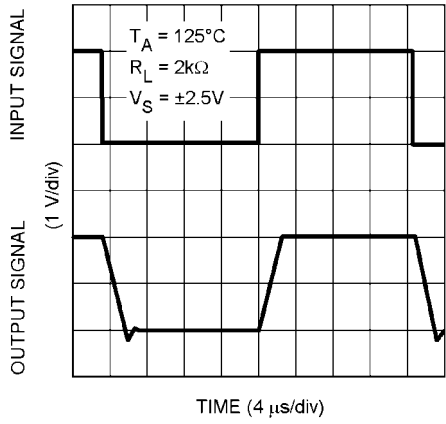

20030409

Non-Inverting Small Signal Pulse Response

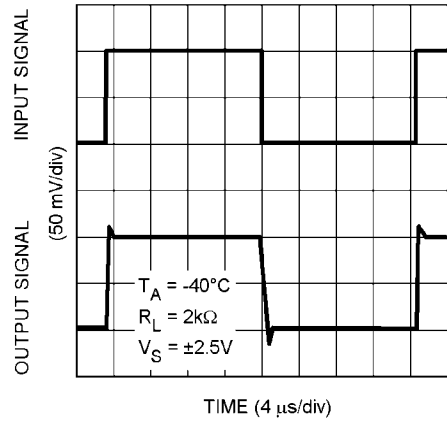

20030407

Non-Inverting Large Signal Pulse Response

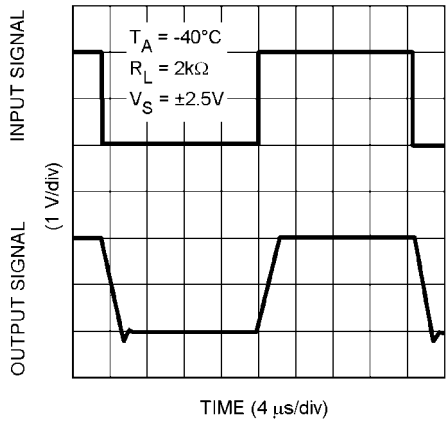

20030410

Inverting Small Signal Pulse Response

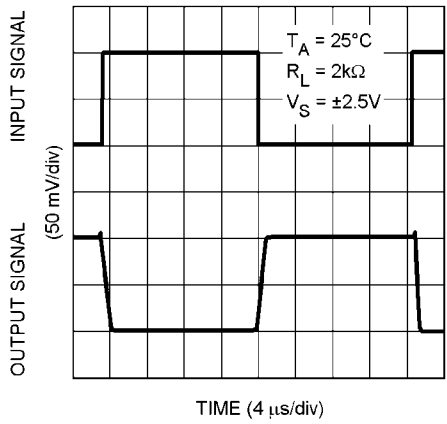

20030411

Inverting Large Signal Pulse Response

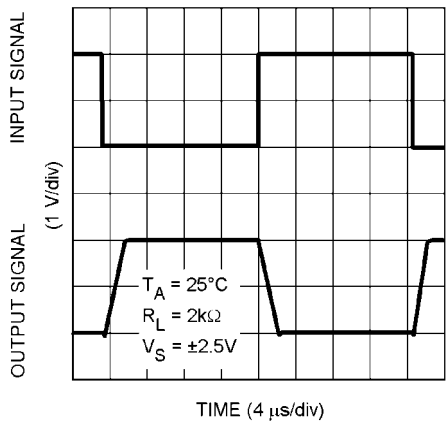

20030414

Inverting Small Signal Pulse Response

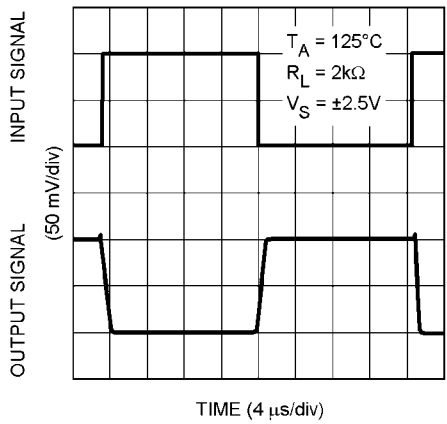

20030412

Inverting Large Signal Pulse Response

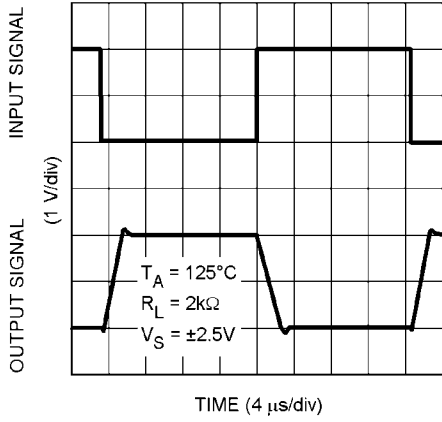

20030415

Inverting Small Signal Pulse Response

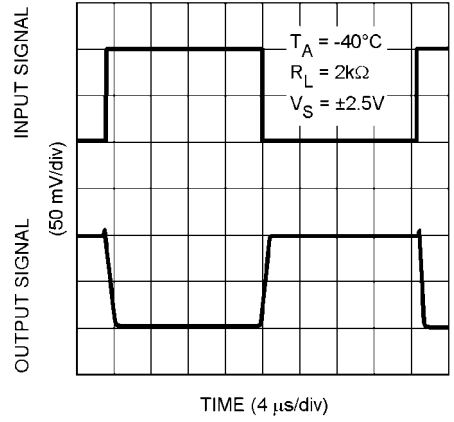

20030413

Inverting Large Signal Pulse Response

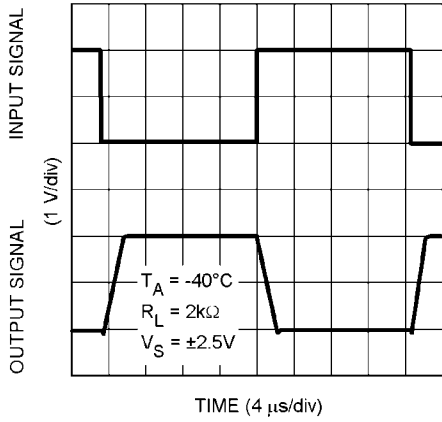

20030416

Crosstalk Rejection vs. Frequency

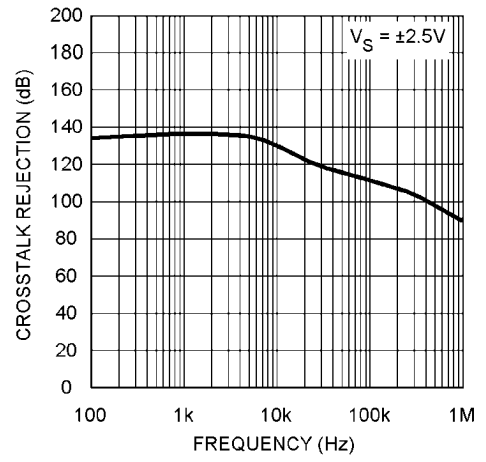

20030454

Application Section

LMV341/LMV342/LMV344

The LMV341/LMV342/LMV344 family of amplifiers features low voltage, low power, and rail-to-rail output operational amplifiers designed for low voltage portable applications. The family is designed using all CMOS technology. This results in an ultra low input bias current. The LMV341 has a shutdown option, which can be used in portable devices to increase battery life.

A simplified schematic of the LMV341/LMV342/LMV344 family of amplifiers is shown in *Figure 1*. The PMOS input differential pair allows the input to include ground. The output of this differential pair is connected to the Class AB turnaround stage. This Class AB turnaround has a lower quiescent current, compared to regular turnaround stages. This results in lower offset, noise, and power dissipation, while slew rate equals that of a conventional turnaround stage. The output of the Class AB turnaround stage provides gate voltage to the complementary common-source transistors at the output stage. These transistors enable the device to have rail-to-rail output.

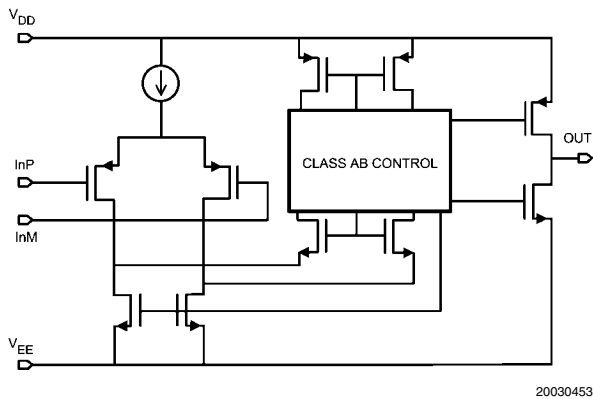

FIGURE 1. Simplified Schematic

CLASS AB TURNAROUND STAGE AMPLIFIER

This patented folded cascode stage has a combined class AB amplifier stage, which replaces the conventional folded cascode stage. Therefore, the class AB folded cascode stage runs at a much lower quiescent current compared to conventional folded cascode stages. This results in significantly smaller offset and noise contributions. The reduced offset and noise contributions in turn reduce the offset voltage level and the voltage noise level at the input of the LMV341/LMV342/LMV344. Also the lower quiescent current results in a high open-loop gain for the amplifier. The lower quiescent current does not affect the slew rate of the amplifier nor its ability to handle the total current swing coming from the input stage.

The input voltage noise of the device at low frequencies, below 1kHz, is slightly higher than devices with a BJT input stage; However the PMOS input stage results in a much lower input bias current and the input voltage noise drops at frequencies above 1kHz.

SAMPLE AND HOLD CIRCUIT

The lower input bias current of the LMV341 results in a very high input impedance. The output impedance when the device is in shutdown mode is quite high. These high impedances, along with the ability of the shutdown pin to be derived from a separate power source, make LMV341 a good choice for sample and hold circuits. The sample clock should be connected to the shutdown pin of the amplifier to rapidly turn the device on or off.

Figure 2 shows the schematic of a simple sample and hold circuit. When the sample clock is high the first amplifier is in normal operation mode and the second amplifier acts as a buffer. The capacitor, which appears as a load on the first amplifier, will be charging at this time. The voltage across the capacitor is that of the non-inverting input of the first amplifier since it is connected as a voltage-follower. When the sample clock is low the first amplifier is shut off, bringing the output impedance to a high value. The high impedance of this output, along with the very high impedance on the input of the second amplifier, prevents the capacitor from discharging. There is very little voltage droop while the first amplifier is in shutdown mode. The second amplifier, which is still in normal operation mode and is connected as a voltage follower, also provides the voltage sampled on the capacitor at its output.

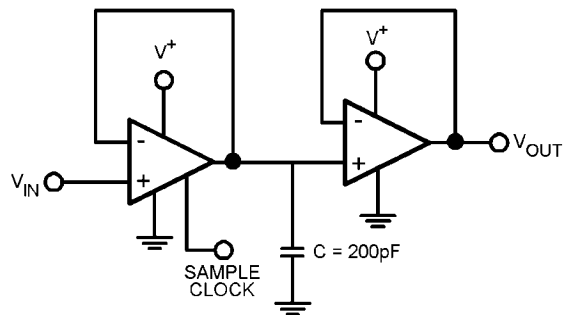

FIGURE 2. Sample and Hold Circuit

SHUTDOWN FEATURE

The LMV341 is capable of being turned off in order to conserve power and increase battery life in portable devices. Once in shutdown mode the supply current is drastically reduced, 1 μ A maximum, and the output will be "tri-stated."

The device will be disabled when the shutdown pin voltage is pulled low. The shutdown pin should never be left unconnected. Leaving the pin floating will result in an undefined operation mode and the device may oscillate between shutdown and active modes.

The LMV341 typically turns on 2.8 μ s after the shutdown voltage is pulled high. The device turns off in less than 400ns after shutdown voltage is pulled low. *Figure 3* and *Figure 4* show the turn-on and turn-off time of the LMV341, respectively. In order to reduce the effect of the capacitance added to the circuit by the scope probe, in the turn-off time circuit a resistive load of 600 Ω is added. *Figure 5* and *Figure 6* show the test circuits used to obtain the two plots.

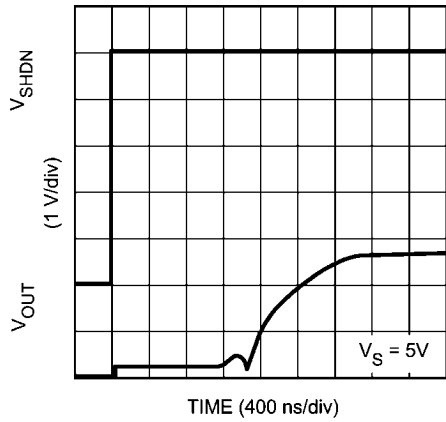

FIGURE 3. Turn-on Time

20030440

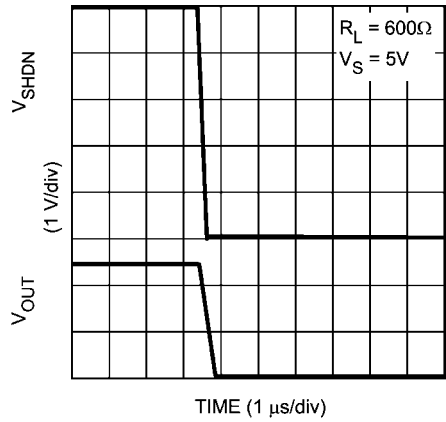

FIGURE 4. Turn-off Time

20030439

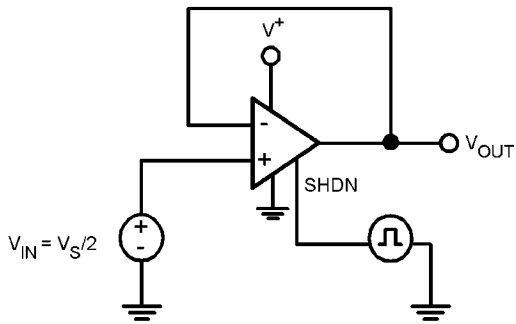

FIGURE 5. Turn-on Time

20030442

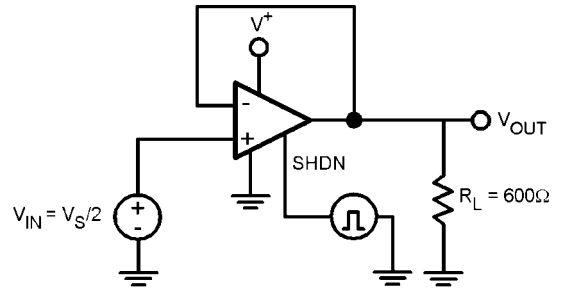

FIGURE 6. Turn-off Time

20030443

LOW INPUT BIAS CURRENT

The LMV341/LMV342/LMV344 Amplifiers have a PMOS input stage. As a result, they will have a much lower input bias current than devices with BJT input stages. This feature makes these devices ideal for sensor circuits. A typical curve of the input bias current of the LMV341 is shown in Figure 7.

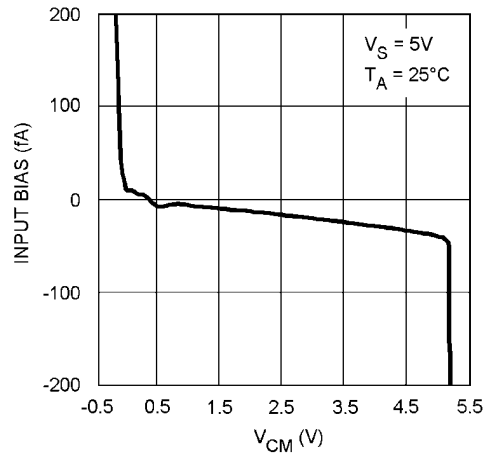
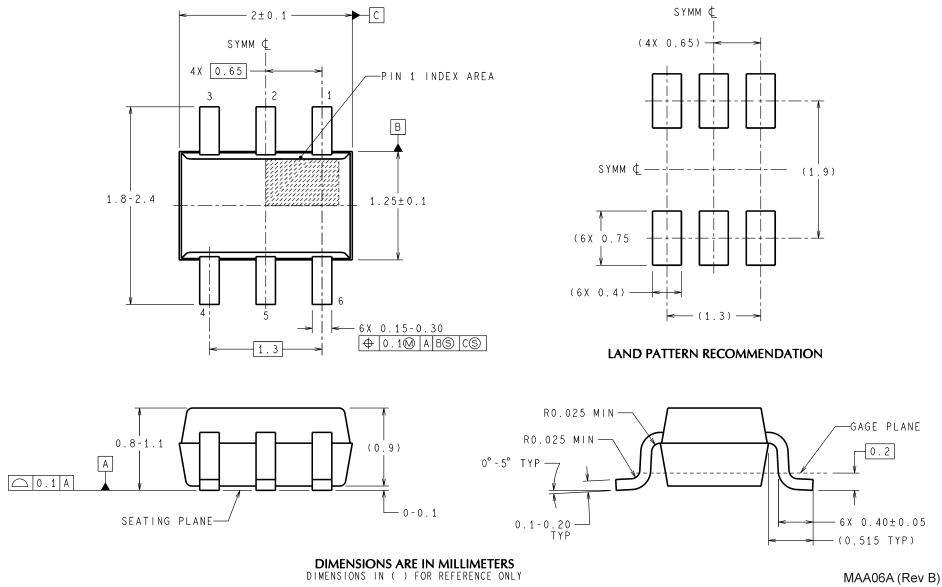

FIGURE 7. Input Bias Current vs. V_{CM}

20030447

Physical Dimensions inches (millimeters) unless otherwise noted



6-Pin SC70
NS Package Number MAA06A

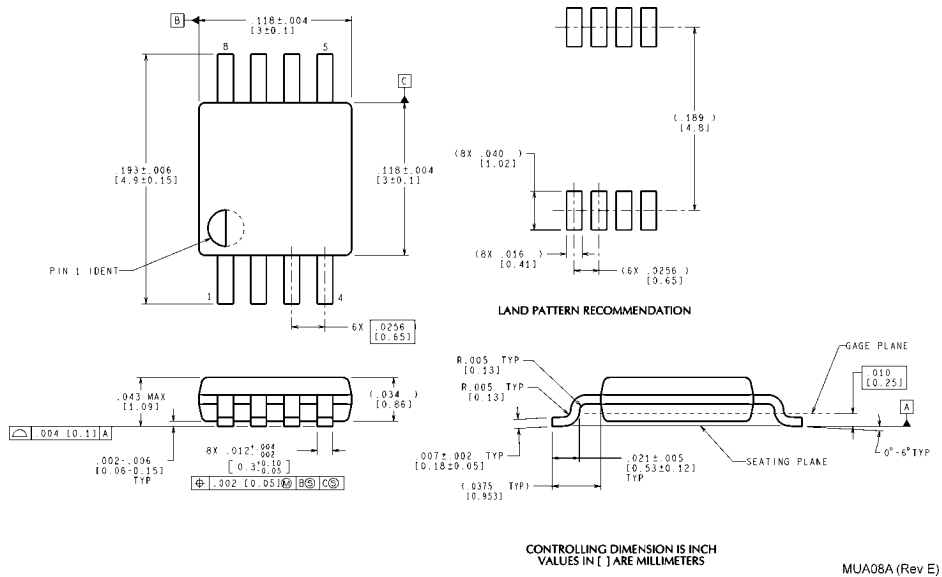

8-Pin MSOP
NS Package Number MUA08A

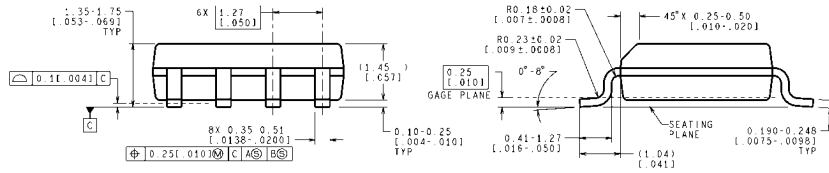
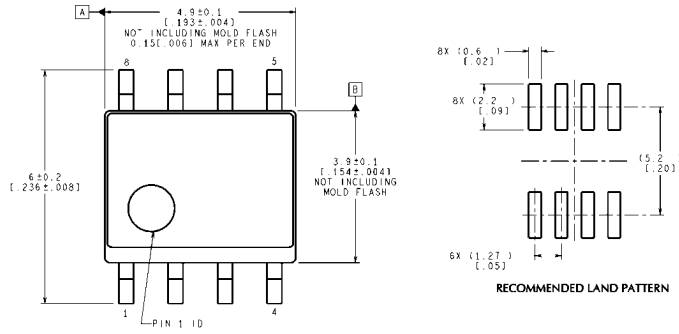

CONTROLLING DIMENSION IS MILLIMETER
VALUES IN [] ARE INCHES
DIMENSIONS IN () FOR REFERENCE ONLY

M08A (Rev L)

8-Pin SOIC
NS Package Number M08A

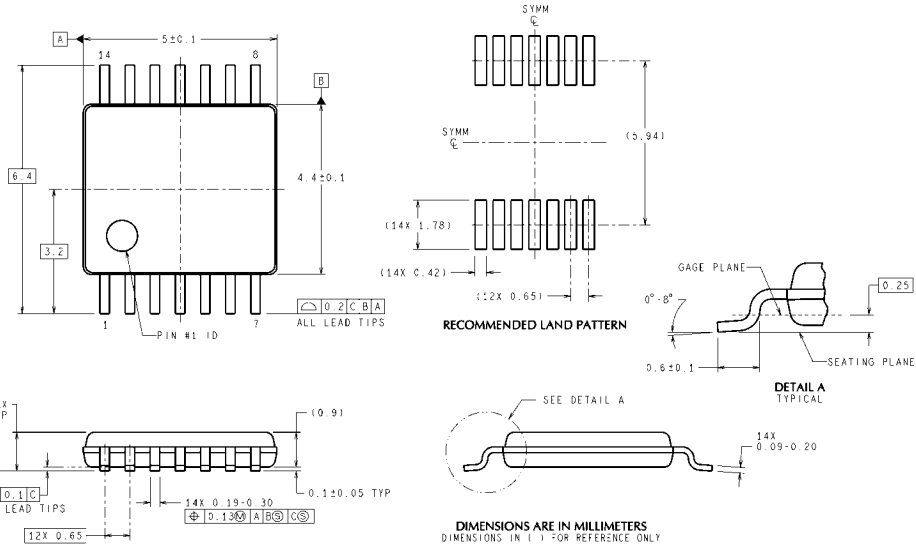

MTC14 (Rev D)

14-Pin TSSOP
NS Package Number MTC14

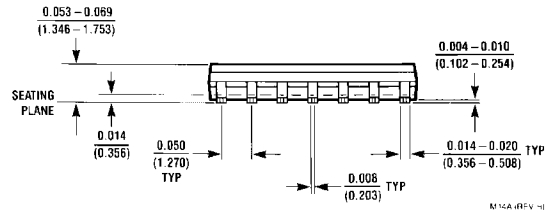
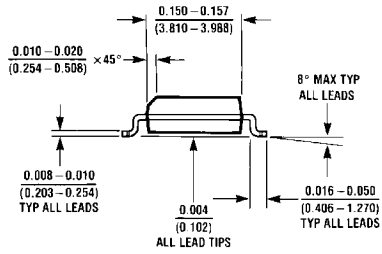
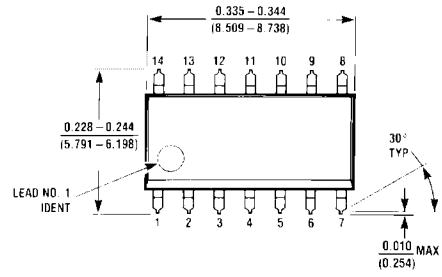

14-Pin SOIC
NS Package Number M14A

Notes

For more National Semiconductor product information and proven design tools, visit the following Web sites at:

| Products | | Design Support | |
|--------------------------------|--|-------------------------|--|
| Amplifiers | www.national.com/amplifiers | WEBENCH | www.national.com/webench |
| Audio | www.national.com/audio | Analog University | www.national.com/AU |
| Clock Conditioners | www.national.com/timing | App Notes | www.national.com/appnotes |
| Data Converters | www.national.com/adc | Distributors | www.national.com/contacts |
| Displays | www.national.com/displays | Green Compliance | www.national.com/quality/green |
| Ethernet | www.national.com/ethernet | Packaging | www.national.com/packaging |
| Interface | www.national.com/interface | Quality and Reliability | www.national.com/quality |
| LVDS | www.national.com/lvds | Reference Designs | www.national.com/refdesigns |
| Power Management | www.national.com/power | Feedback | www.national.com/feedback |
| Switching Regulators | www.national.com/switchers | | |
| LDOs | www.national.com/lido | | |
| LED Lighting | www.national.com/led | | |
| PowerWise | www.national.com/powerwise | | |
| Serial Digital Interface (SDI) | www.national.com/sdi | | |
| Temperature Sensors | www.national.com/tempsensors | | |
| Wireless (PLL/VCO) | www.national.com/wireless | | |

THE CONTENTS OF THIS DOCUMENT ARE PROVIDED IN CONNECTION WITH NATIONAL SEMICONDUCTOR CORPORATION ("NATIONAL") PRODUCTS. NATIONAL MAKES NO REPRESENTATIONS OR WARRANTIES WITH RESPECT TO THE ACCURACY OR COMPLETENESS OF THE CONTENTS OF THIS PUBLICATION AND RESERVES THE RIGHT TO MAKE CHANGES TO SPECIFICATIONS AND PRODUCT DESCRIPTIONS AT ANY TIME WITHOUT NOTICE. NO LICENSE, WHETHER EXPRESS, IMPLIED, ARISING BY ESTOPPEL OR OTHERWISE, TO ANY INTELLECTUAL PROPERTY RIGHTS IS GRANTED BY THIS DOCUMENT.

TESTING AND OTHER QUALITY CONTROLS ARE USED TO THE EXTENT NATIONAL DEEMS NECESSARY TO SUPPORT NATIONAL'S PRODUCT WARRANTY. EXCEPT WHERE MANDATED BY GOVERNMENT REQUIREMENTS, TESTING OF ALL PARAMETERS OF EACH PRODUCT IS NOT NECESSARILY PERFORMED. NATIONAL ASSUMES NO LIABILITY FOR APPLICATIONS ASSISTANCE OR BUYER PRODUCT DESIGN. BUYERS ARE RESPONSIBLE FOR THEIR PRODUCTS AND APPLICATIONS USING NATIONAL COMPONENTS. PRIOR TO USING OR DISTRIBUTING ANY PRODUCTS THAT INCLUDE NATIONAL COMPONENTS, BUYERS SHOULD PROVIDE ADEQUATE DESIGN, TESTING AND OPERATING SAFEGUARDS.

EXCEPT AS PROVIDED IN NATIONAL'S TERMS AND CONDITIONS OF SALE FOR SUCH PRODUCTS, NATIONAL ASSUMES NO LIABILITY WHATSOEVER, AND NATIONAL DISCLAIMS ANY EXPRESS OR IMPLIED WARRANTY RELATING TO THE SALE AND/OR USE OF NATIONAL PRODUCTS INCLUDING LIABILITY OR WARRANTIES RELATING TO FITNESS FOR A PARTICULAR PURPOSE, MERCHANTABILITY, OR INFRINGEMENT OF ANY PATENT, COPYRIGHT OR OTHER INTELLECTUAL PROPERTY RIGHT.

LIFE SUPPORT POLICY

NATIONAL'S PRODUCTS ARE NOT AUTHORIZED FOR USE AS CRITICAL COMPONENTS IN LIFE SUPPORT DEVICES OR SYSTEMS WITHOUT THE EXPRESS PRIOR WRITTEN APPROVAL OF THE CHIEF EXECUTIVE OFFICER AND GENERAL COUNSEL OF NATIONAL SEMICONDUCTOR CORPORATION. As used herein:

Life support devices or systems are devices which (a) are intended for surgical implant into the body, or (b) support or sustain life and whose failure to perform when properly used in accordance with instructions for use provided in the labeling can be reasonably expected to result in a significant injury to the user. A critical component is any component in a life support device or system whose failure to perform can be reasonably expected to cause the failure of the life support device or system or to affect its safety or effectiveness.

National Semiconductor and the National Semiconductor logo are registered trademarks of National Semiconductor Corporation. All other brand or product names may be trademarks or registered trademarks of their respective holders.

Copyright© 2008 National Semiconductor Corporation

For the most current product information visit us at www.national.com



**National Semiconductor
Americas Technical
Support Center**
Email:
new.feedback@nsc.com
Tel: 1-800-272-9959

**National Semiconductor Europe
Technical Support Center**
Email: europe.support@nsc.com
German Tel: +49 (0) 180 5010 771
English Tel: +44 (0) 870 850 4288

**National Semiconductor Asia
Pacific Technical Support Center**
Email: ap.support@nsc.com

**National Semiconductor Japan
Technical Support Center**
Email: jpn.feedback@nsc.com