

March 1993

## Quad Operational Amplifier

### Features

- Slew Rate .....1.6V/ $\mu$ s
- Bandwidth.....3.5MHz
- Input Voltage Noise .....9nV/ $\sqrt{\text{Hz}}$
- Input Offset Voltage.....0.5mV
- Input Bias Current .....60nA
- Supply Range ..... $\pm 2\text{V}$  to  $\pm 20\text{V}$
- No Crossover Distortion
- Standard Quad Pinout

### Applications

- Universal Active Filters
- D3 Communications Filters
- Audio Amplifiers
- Battery-Powered Equipment

### Description

HA-4741, which contains four amplifiers on a monolithic chip, provides a new measure of performance for general purpose operational amplifiers. Each amplifier in the HA-4741 has operating specifications that equal or exceed those of the 741-type amplifier in all categories of performance.

HA-4741 is well suited to applications requiring accurate signal processing by virtue of its low values of input offset voltage (0.5mV), input bias current (60nA) and input voltage noise (9nV/ $\sqrt{\text{Hz}}$  at 1kHz). 3.5MHz bandwidth, coupled with high open-loop gain, allow the HA-4741 to be used in designs requiring amplification of wide band signals, such as audio amplifiers. Audio application is further enhanced by the HA-4741's negligible output crossover distortion.

These excellent dynamic characteristics also make the HA-4741 ideal for a wide range of active filter designs. Performance integrity of multi-channel designs is assured by a high level of amplifier -to-amplifier isolation (69dB at 10kHz).

A wide range of supply voltages ( $\pm 2\text{V}$  to  $\pm 20\text{V}$ ) can be used to power the HA-4741, making it compatible with almost any system including battery-powered equipment.

HA-4741/883 product and data sheets available upon request.

### Ordering Information

PART NUMBER	TEMPERATURE RANGE	PACKAGE
HA1-4741-2	-55°C to +125°C	14 Lead Ceramic DIP
HA1-4741-5	0°C to +75°C	14 Lead Ceramic DIP
HA3-4741-5	0°C to +75°C	14 Lead Plastic DIP
HA4P4741-5	0°C to +75°C	20 Lead PLCC
HA9P4741-5	0°C to +75°C	16 Lead Wide Body SOIC
HA9P4741-9	-40°C to +85°C	16 Lead Wide Body SOIC

### Pinouts

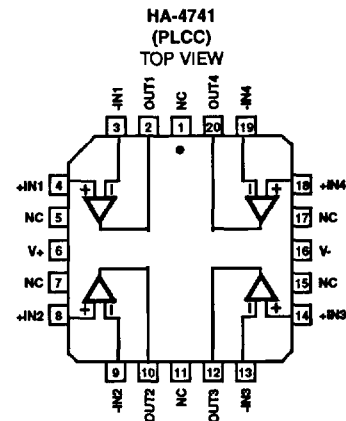
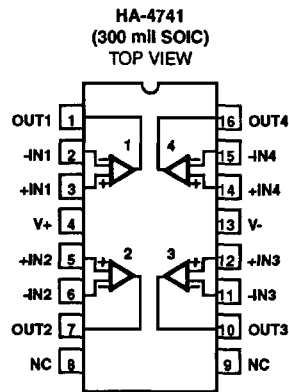
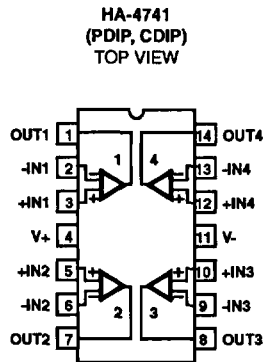

CAUTION: These devices are sensitive to electrostatic discharge. Users should follow proper I.C. Handling Procedures.  
Copyright © Harris Corporation 1993

File Number 2922.1

## Specifications HA-4741

### Absolute Maximum Ratings (Note 13)

$T_A = +25^\circ\text{C}$ Unless Otherwise Stated	
Supply Voltage Between $V_+$ and $V_-$ Terminals	40.0V
Differential Input Voltage	30.0V
Input Voltage (Note 1)	$\pm 15.0\text{V}$
Output Short Circuit Duration (Note 2)	Indefinite
Junction Temperature (Note 3)	$+175^\circ\text{C}$
Junction Temperature (Plastic Package)	$+150^\circ\text{C}$
Lead Temperature (Soldering 10 Sec.)	$+300^\circ\text{C}$

### Operating Conditions

Operating Temperature Range:	
HA-4741-2	$-55^\circ\text{C} \leq T_A \leq +125^\circ\text{C}$
HA-4741-5	$0^\circ\text{C} \leq T_A \leq +75^\circ\text{C}$
HA-4741-9	$-40^\circ\text{C} \leq T_A \leq +85^\circ\text{C}$
Storage Temperature Range	$-65^\circ\text{C} \leq T_A \leq +150^\circ\text{C}$
Thermal Package Characteristics ( $^\circ\text{C}/\text{W}$ )	$\theta_{JA}$ $\theta_{JC}$
Ceramic DIP Package	71      13
Plastic DIP Package	107      38
SOIC	96      26
PLCC	74      33

*CAUTION: Stresses above those listed in "Absolute Maximum Ratings" may cause permanent damage to the device. This is a stress only rating and operation of the device at these or any other conditions above those indicated in the operational sections of this specification is not implied.*

### Electrical Specifications $V_+ = +15\text{V}$ , $V_- = -15\text{V}$ , Unless Otherwise Specified.

PARAMETER	TEMP	HA-4741-2 LIMITS			HA-4741-5 LIMITS			(NOTE 14) HA-4741-9	UNITS
		MIN	TYP	MAX	MIN	TYP	MAX	MAX	
<b>INPUT CHARACTERISTICS</b>									
Offset Voltage	$+25^\circ\text{C}$	-	0.5	3	-	1	5	5	mV
	Full	-	4	5	-	4	6.5	8.5	mV
Average Offset Voltage Drift	Full	-	5	-	-	5	-	-	$\mu\text{V}/^\circ\text{C}$
Bias Current	$+25^\circ\text{C}$	-	60	200	-	60	300	300	nA
	Full	-	-	325	-	-	400	400	nA
Offset Current	$+25^\circ\text{C}$	-	15	30	-	30	50	50	nA
	Full	-	-	75	-	-	100	100	nA
Common Mode Range	Full	$\pm 12$	-	-	$\pm 12$	-	-	-	V
Differential Input Resistance	$+25^\circ\text{C}$	-	0.5	-	-	0.5	-	-	M $\Omega$
Input Voltage Noise ( $f = 1\text{kHz}$ )	$+25^\circ\text{C}$	-	9	-	-	9	-	-	nV/ $\sqrt{\text{Hz}}$
<b>TRANSFER CHARACTERISTICS</b>									
Large Signal Voltage Gain (Note 4)	$+25^\circ\text{C}$	50	100	-	25	50	-	-	kV/V
	Full	25	-	-	15	-	-	-	kV/V
Common Mode Rejection Ratio	$+25^\circ\text{C}$	80	95	-	80	95	-	-	dB
	Full	74	-	-	74	-	-	-	dB
Channel Separation (Note 5)	$+25^\circ\text{C}$	66	69	-	66	69	-	-	dB
Small Signal Bandwidth	$+25^\circ\text{C}$	2.5	3.5	-	2.5	3.5	-	-	MHz
<b>OUTPUT CHARACTERISTICS</b>									
Output Voltage Swing ( $R_L = 10\text{k}\Omega$ )	Full	$\pm 12$	$\pm 13.7$	-	$\pm 12$	$\pm 13.7$	-	-	V
Output Voltage Swing ( $R_L = 2\text{k}\Omega$ )	Full	$\pm 10$	$\pm 12.5$	-	$\pm 10$	$\pm 12.5$	-	-	V
Full Power Bandwidth (Notes 4, 9)	$+25^\circ\text{C}$	14	25	-	14	25	-	-	kHz
Output Current (Note 6)	Full	$\pm 5$	$\pm 15$	-	$\pm 5$	$\pm 15$	-	-	mA
Output Resistance	$+25^\circ\text{C}$	-	300	-	-	300	-	-	$\Omega$
<b>TRANSIENT RESPONSE (Notes 7, 10)</b>									
Rise Time (Note 11)	$+25^\circ\text{C}$	-	75	140	-	75	140	140	ns
Overshoot (Note 11)	$+25^\circ\text{C}$	-	25	40	-	25	40	40	%
Slew Rate (Note 12)	$+25^\circ\text{C}$	-	$\pm 1.6$	-	-	$\pm 1.6$	-	-	V/ $\mu\text{s}$

2  
OPERATIONAL  
AMPLIFIERS

## Specifications HA-4741

**Electrical Specifications**  $V_+ = +15V$ ,  $V_- = -15V$ , Unless Otherwise Specified. (Continued)

PARAMETER	TEMP	HA-4741-2 LIMITS			HA-4741-5 LIMITS			(NOTE 14) HA-4741-9	UNITS
		MIN	TYP	MAX	MIN	TYP	MAX	MAX	
POWER SUPPLY CHARACTERISTICS									
Supply Current	+25°C	-	4.5	5	-	5	7	7	mA
Power Supply Rejection Ratio (Note 8)	Full	80	95	-	80	95	-	-	dB

**NOTES:**

1. For supply voltages less than  $\pm 15V$ , the absolute maximum input voltage is equal to the supply voltage.
2. One amplifier may be shorted to ground indefinitely.
3. Maximum power dissipation, including output load, must be designed to maintain junction temperature below  $+175^\circ C$  for the ceramic package, and below  $+150^\circ C$  for the plastic packages.
4.  $V_{OUT} = \pm 10V$ ,  $R_L = 2k\Omega$ .
5. Referred to input;  $f = 10kHz$ ,  $R_S = 1K$ ,  $V_{IN} = 100mV_{PEAK}$ .
6.  $V_{OUT} = \pm 10V$ .
7. See Pulse Response Characteristics.
8.  $\Delta V = \pm 5V$ .
9. Full power bandwidth guaranteed based upon slew rate measurement  $FPBW = S.R./2\pi V_{PEAK}$ .
10.  $R_L = 2k\Omega$ ,  $C_L = 50pF$ .
11.  $V_{OUT} = \pm 200mV$ .
12.  $V_{OUT} = \pm 5V$ .
13. Absolute maximum ratings are limiting values, applied individually beyond which the serviceability of the circuit may be impaired. Functional operability under any of these conditions is not necessarily implied.
14. Typical and Minimum specifications for the -9 version are the same as those for the -5 version.

### Schematic Diagram

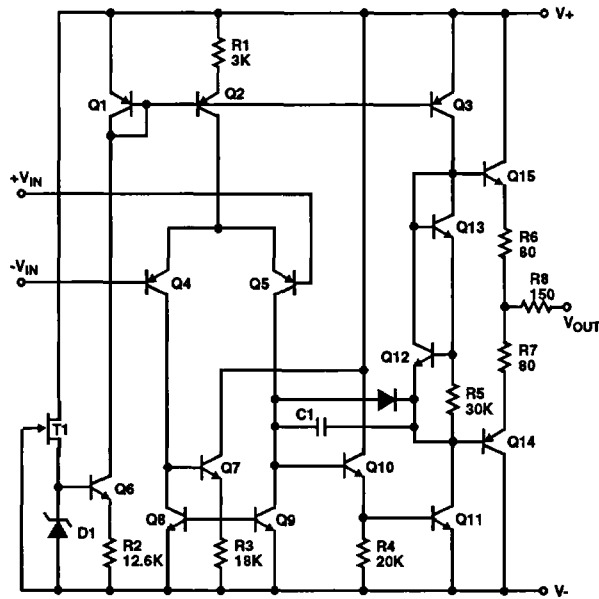

Typical Performance Curves  $V_+ = +15V, V_- = -15V, T_A = +25^\circ C$ , Unless Otherwise Specified

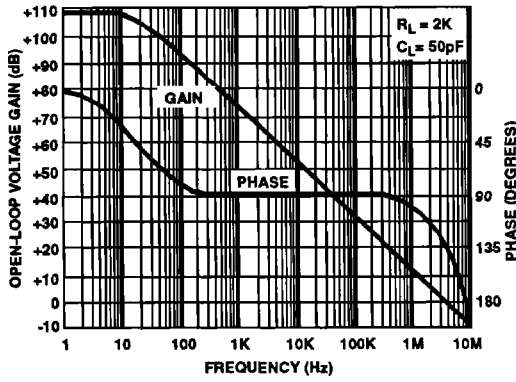

FIGURE 1. OPEN LOOP FREQUENCY RESPONSE

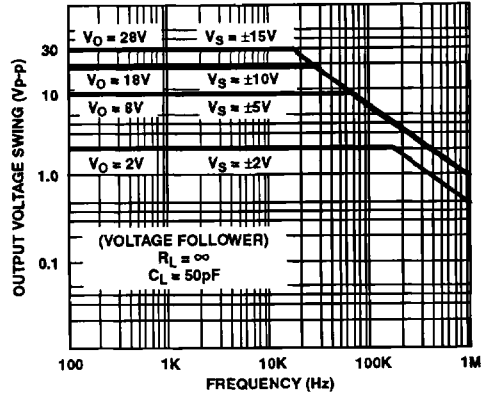

FIGURE 2. OUTPUT VOLTAGE SWING vs FREQUENCY

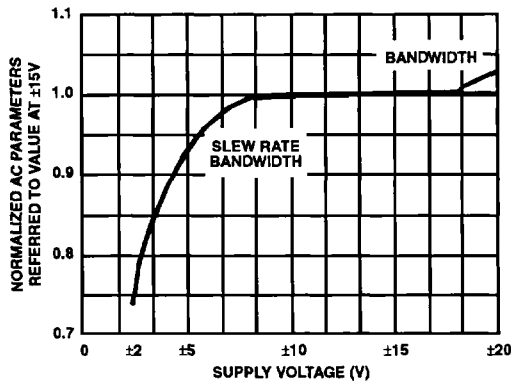

FIGURE 3. NORMALIZED AC PARAMETERS vs SUPPLY VOLTAGE

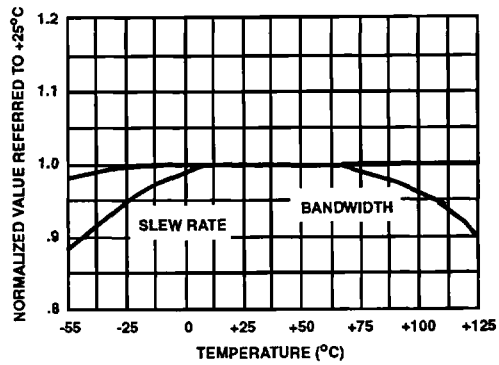

FIGURE 4. NORMALIZED AC PARAMETERS vs TEMPERATURE

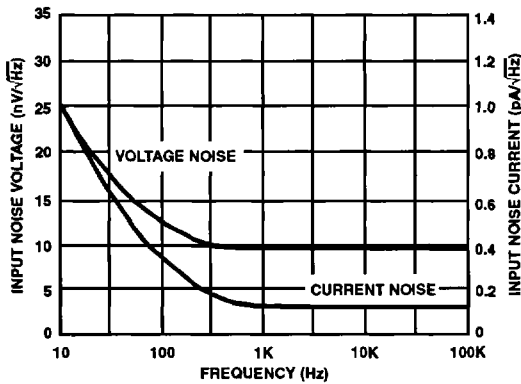

FIGURE 5. INPUT NOISE vs FREQUENCY

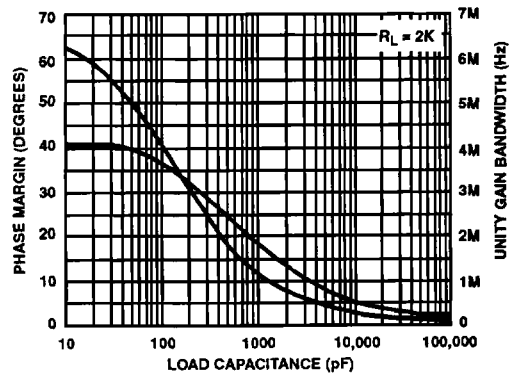

FIGURE 6. SMALL SIGNAL BANDWIDTH AND PHASE MARGIN vs LOAD CAPACITANCE

**Typical Performance Curves**  $V_+ = +15V$ ,  $V_- = -15V$ ,  $T_A = +25^\circ C$ , Unless Otherwise Specified (Continued)

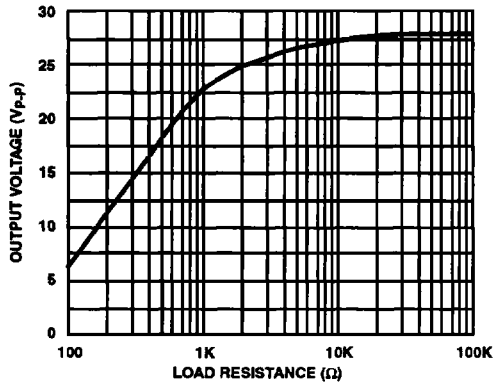

FIGURE 7. MAXIMUM OUTPUT VOLTAGE SWING vs LOAD RESISTANCE

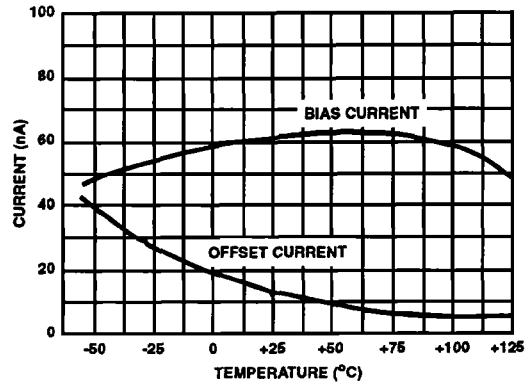

FIGURE 8. INPUT BIAS AND OFFSET CURRENT vs TEMPERATURE

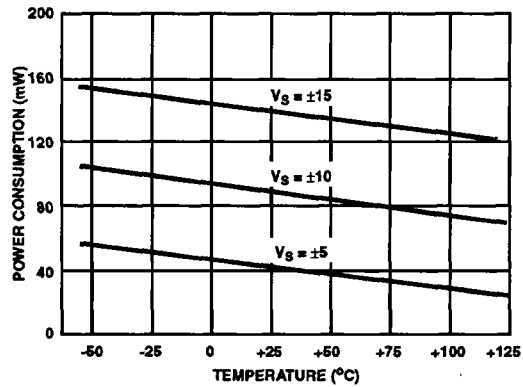

FIGURE 9. POWER CONSUMPTION vs TEMPERATURE

Pulse Response

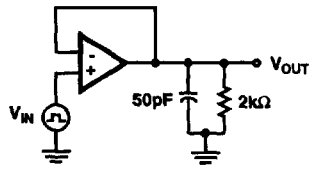

FIGURE 10. TRANSIENT RESPONSE/SLEW RATE CIRCUIT

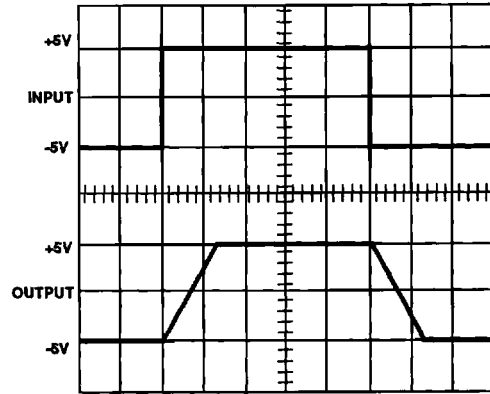

FIGURE 11. SLEW RESPONSE  
(Volts: 5V/Div., Time: 5μs/Div.)

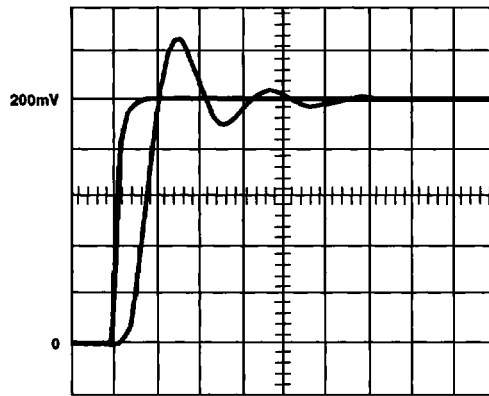

FIGURE 12. TRANSIENT RESPONSE  
(Volts: 40mV/Div., Time 100ns/Div.)