

## 100MHz, Single and Dual Low Noise, Precision Operational Amplifiers

November 1996

### Features

- Gain Bandwidth Product ..... 100MHz
- Unity Gain Bandwidth ..... 25MHz
- Slew Rate ..... 25V/ $\mu$ s
- Low Offset Voltage ..... 0.3mV
- High Open Loop Gain ..... 128dB
- Channel Separation at 10kHz ..... 110dB
- Low Noise Voltage at 1kHz ..... 3.4nV/ $\sqrt{\text{Hz}}$
- High Output Current ..... 56mA
- Low Supply Current per Amplifier ..... 8mA

### Applications

- Precision Test Systems
- Active Filtering
- Small Signal Video
- Accurate Signal Processing
- RF Signal Conditioning

### Description

The HA-5221/5222 are single and dual high performance dielectrically isolated, op amps, featuring precision DC characteristics while providing excellent AC characteristics. Designed for audio, video, and other demanding applications, noise (3.4nV/ $\sqrt{\text{Hz}}$  at 1kHz), total harmonic distortion (<0.005%), and DC errors are kept to a minimum.

The precision performance is shown by low offset voltage (0.3mV), low bias currents (40nA), low offset currents (15nA), and high open loop gain (128dB). The combination of these excellent DC characteristics with the fast settling time (0.4 $\mu$ s) make the HA-5221/5222 ideally suited for precision signal conditioning.

The unique design of the HA-5221/5222 gives them outstanding AC characteristics not normally associated with precision op amps, high unity gain bandwidth (35MHz) and high slew rate (25V/ $\mu$ s). Other key specifications include high CMRR (95dB) and high PSRR (100dB). The combination of these specifications will allow the HA-5221/5222 to be used in RF signal conditioning as well as video amplifiers.

For MIL-STD-883C compliant product and Ceramic LCC packaging, consult the HA-5221/5222/883C data sheet. Harris AnswerFAX (407-724-7800) Document #3716.

### Pinouts

HA-5221  
(PDIP, Cerdip, SOIC)  
TOP VIEW

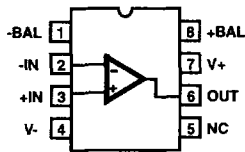

HA-5221  
(METAL CAN)  
TOP VIEW

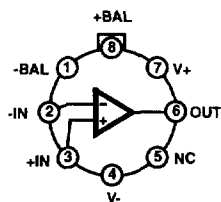

HA-5222 (PDIP, SOIC)  
TOP VIEW

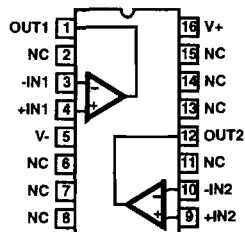

HA-5222 (CERDIP)  
TOP VIEW

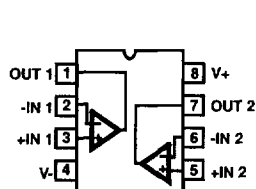

### Ordering Information

PART NUMBER (BRAND)	TEMP. RANGE (°C)	PACKAGE	PKG. NO.
HA2-5221-5	0 to 75	8 Pin Metal Can	T8.C
HA3-5221-5	0 to 75	8 Ld PDIP	E8.3
HA7-5221-5	0 to 75	8 Ld CERDIP	F8.3A
HA7-5221-9	-40 to 85	8 Ld CERDIP	F8.3A
HA9P5221-5 (H52215)	0 to 75	8 Ld SOIC	M8.15
HA3-5222-5	0 to 75	16 Ld PDIP	E16.3
HA7-5222-5	0 to 75	8 Ld CERDIP	F8.3A
HA7-5222-9	-40 to 85	8 Ld CERDIP	F8.3A
HA9P5222-5	0 to 75	16 Ld SOIC	M16.3
HA9P5222-9	-40 to 85	16 Ld SOIC	M16.3

## HA-5221, HA-5222

### Absolute Maximum Ratings

Supply Voltage Between V+ and V- Terminals	35V
Differential Input Voltage (Note 1)	5V
Output Current Short Circuit Duration	Indefinite

### Operating Conditions

Temperature Range	
HA-5221/5222-9	-40°C to 85°C
HA-5221/5222-5	0°C to 75°C

### Thermal Information

Thermal Resistance (Typical, Note 2)	$\theta_{JA}$ (°C/W)	$\theta_{JC}$ (°C/W)
Metal Can Package	165	80
CERDIP Package (HA7-5221)	135	50
CERDIP Package (HA7-5222)	115	30
8 Ld PDIP Package	92	N/A
8 Ld SOIC Package	157	N/A
16 Ld PDIP Package	85	N/A
16 Ld SOIC Package	95	N/A
Maximum Junction Temperature (Hermetic Package)	175°C	
Maximum Junction Temperature (Plastic Package)	150°C	
Maximum Storage Temperature Range	-65°C to 150°C	
Maximum Lead Temperature (Soldering 10s)	300°C	
(SOIC - Lead Tips Only)		

*CAUTION: Stresses above those listed in "Absolute Maximum Ratings" may cause permanent damage to the device. This is a stress only rating and operation of the device at these or any other conditions above those indicated in the operational sections of this specification is not implied.*

### NOTES:

- Input is protected by back-to-back zener diodes. See applications section.
- $\theta_{JA}$  is measured with the component mounted on an evaluation PC board in free air.

### Electrical Specifications $V_{SUPPLY} = \pm 15V$ , Unless Otherwise Specified

PARAMETER	TEST CONDITIONS	TEMP. (°C)	HA-5221-9, HA-5222-9			HA-5221-5, HA-5222-5			UNITS
			MIN	TYP	MAX	MIN	TYP	MAX	
<b>INPUT CHARACTERISTICS</b>									
Input Offset Voltage		25	-	0.30	0.75	-	0.30	0.75	mV
		Full	-	0.35	1.5	-	0.35	1.5	mV
Average Offset Voltage Drift		Full	-	0.5	-	-	0.5	-	$\mu V/^\circ C$
Input Bias Current		25	-	40	80	-	40	100	nA
		Full	-	70	200	-	70	200	nA
Input Offset Current		25	-	15	50	-	15	100	nA
		Full	-	30	150	-	30	150	nA
Input Offset Voltage Match		25	-	400	750	-	400	750	$\mu V$
		Full	-	-	1500	-	-	1500	$\mu V$
Common Mode Range		25	$\pm 12$	-	-	$\pm 12$	-	-	V
Differential Input Resistance		25	-	70	-	-	70	-	k $\Omega$
Input Noise Voltage	f = 0.1Hz to 10Hz	25	-	0.25	-	-	0.25	-	$\mu V_{p-p}$
Input Noise Voltage	f = 10Hz	25	-	6.2	10	-	6.2	10	nV/ $\sqrt{Hz}$
Density (Notes 3, 12)	f = 100Hz	25	-	3.6	6	-	3.6	6	nV/ $\sqrt{Hz}$
	f = 1000Hz	25	-	3.4	4.0	-	3.4	4.0	nV/ $\sqrt{Hz}$
Input Noise Current	f = 10Hz	25	-	4.7	8.0	-	4.7	8.0	pA/ $\sqrt{Hz}$
Density (Notes 3, 12)	f = 100Hz	25	-	1.8	2.8	-	1.8	2.8	pA/ $\sqrt{Hz}$
	f = 1000Hz	25	-	0.97	1.8	-	0.97	1.8	pA/ $\sqrt{Hz}$
THD+N	Note 4	25	-	<0.005	-	-	<0.005	-	%

## HA-5221, HA-5222

### Electrical Specifications $V_{SUPPLY} = \pm 15V$ , Unless Otherwise Specified (Continued)

PARAMETER	TEST CONDITIONS	TEMP. (°C)	HA-5221-9, HA-5222-9			HA-5221-5, HA-5222-5			UNITS
			MIN	TYP	MAX	MIN	TYP	MAX	
<b>TRANSFER CHARACTERISTICS</b>									
Large Signal Voltage Gain	Note 5	25	106	128	-	106	128	-	dB
		Full	100	120	-	100	120	-	dB
CMRR	$V_{CM} = \pm 10V$	Full	86	95	-	86	95	-	dB
Unity Gain Bandwidth	-3dB	25	-	35	-	-	35	-	MHz
Gain Bandwidth Product	1kHz to 400kHz	25	-	100	-	-	100	-	MHz
Minimum Stable Gain		Full	1	-	-	1	-	-	V/V
<b>OUTPUT CHARACTERISTICS</b>									
Output Voltage Swing	$R_L = 333\Omega$	Full	$\pm 10$	-	-	$\pm 10$	-	-	V
	$R_L = 1k\Omega$	25	$\pm 12$	$\pm 12.5$	-	$\pm 12$	$\pm 12.5$	-	V
	$R_L = 1k\Omega$	Full	$\pm 11.5$	$\pm 12.1$	-	$\pm 11.5$	$\pm 12.1$	-	V
Output Current	$V_{OUT} = \pm 10V$	Full	$\pm 30$	$\pm 56$	-	$\pm 30$	$\pm 56$	-	mA
Output Resistance		25	-	10	-	-	10	-	$\Omega$
Full Power Bandwidth	Note 6	25	239	398	-	239	398	-	kHz
Channel Separation	Note 7	25	-	110	-	-	110	-	dB
<b>TRANSIENT RESPONSE (Note 11)</b>									
Slew Rate	Notes 8, 12	Full	15	25	-	15	25	-	V/ $\mu$ s
Rise Time	Notes 9, 12	Full	-	13	20	-	13	20	ns
Overshoot	Notes 9, 12	Full	-	28	50	-	28	50	%
Settling Time (Note 10)	0.1%	25	-	0.4	-	-	0.4	-	$\mu$ s
	0.01%	25	-	1.5	-	-	1.5	-	$\mu$ s
<b>POWER SUPPLY</b>									
PSRR	$V_S = \pm 10V$ to $\pm 20V$	Full	86	100	-	86	100	-	dB
Supply Current		Full	-	8	11	-	8	11	mA/Op Amp

**NOTES:**

3. Refer to typical performance curve in data sheet.
4.  $A_{VCL} = 10$ ,  $f_O = 1kHz$ ,  $V_O = 5V_{RMS}$ ,  $R_L = 600\Omega$ , 10Hz to 100kHz, Minimum resolution of test equipment is 0.005%.
5.  $V_{OUT} = 0$  to  $\pm 10V$ ,  $R_L = 1k\Omega$ ,  $C_L = 50pF$ .
6. Full Power Bandwidth is calculated by:  $FPBW = \frac{\text{Slew Rate}}{2\pi V_{PEAK}}$ ,  $V_{PEAK} = 10V$ .
7. HA-5222 only,  $f = 10kHz$ ,  $R_L = 1k\Omega$ ,  $C_L = 50pF$ .
8.  $V_{OUT} = \pm 2.5V$ ,  $R_L = 1k\Omega$ ,  $C_L = 50pF$ .
9.  $V_{OUT} = \pm 100mV$ ,  $R_L = 1k\Omega$ ,  $C_L = 50pF$ .
10. Settling time is specified for a 10V step and  $A_V = -1$ .
11. See Test Circuits.
12. Guaranteed by characterization.

Test Circuits and Waveforms

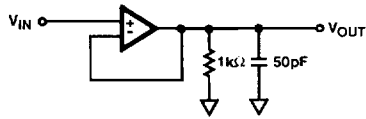
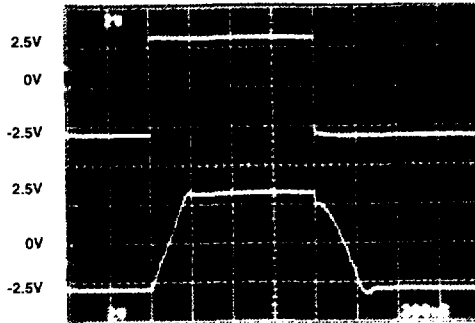
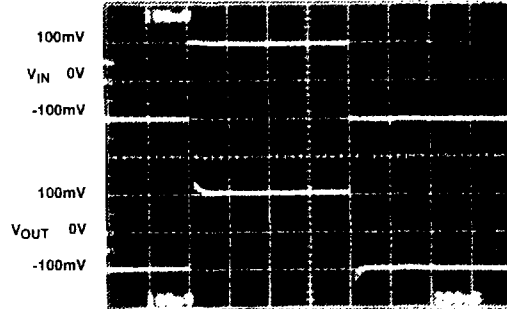

FIGURE 1. TRANSIENT RESPONSE TEST CIRCUIT



$V_{OUT} = 2.5V$   
Vertical Scale = 2V/Div.,  
Horizontal Scale = 200ns/Div.

FIGURE 2. LARGE SIGNAL RESPONSE



$V_{OUT} = \pm 100mV$   
Vertical Scale = 100mV/Div.,  
Horizontal Scale = 200ns/Div.

FIGURE 3. SMALL SIGNAL RESPONSE

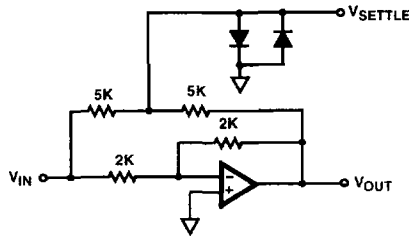

13.  $AV = -1$ .
14. Feedback and summing resistors must be matched (0.1%).
15. HP5082-2810 clipping diodes recommended.
16. Tektronix P6201 FET probe used at settling point.

FIGURE 4. SETTLING TIME TEST CIRCUIT

Schematic Diagram

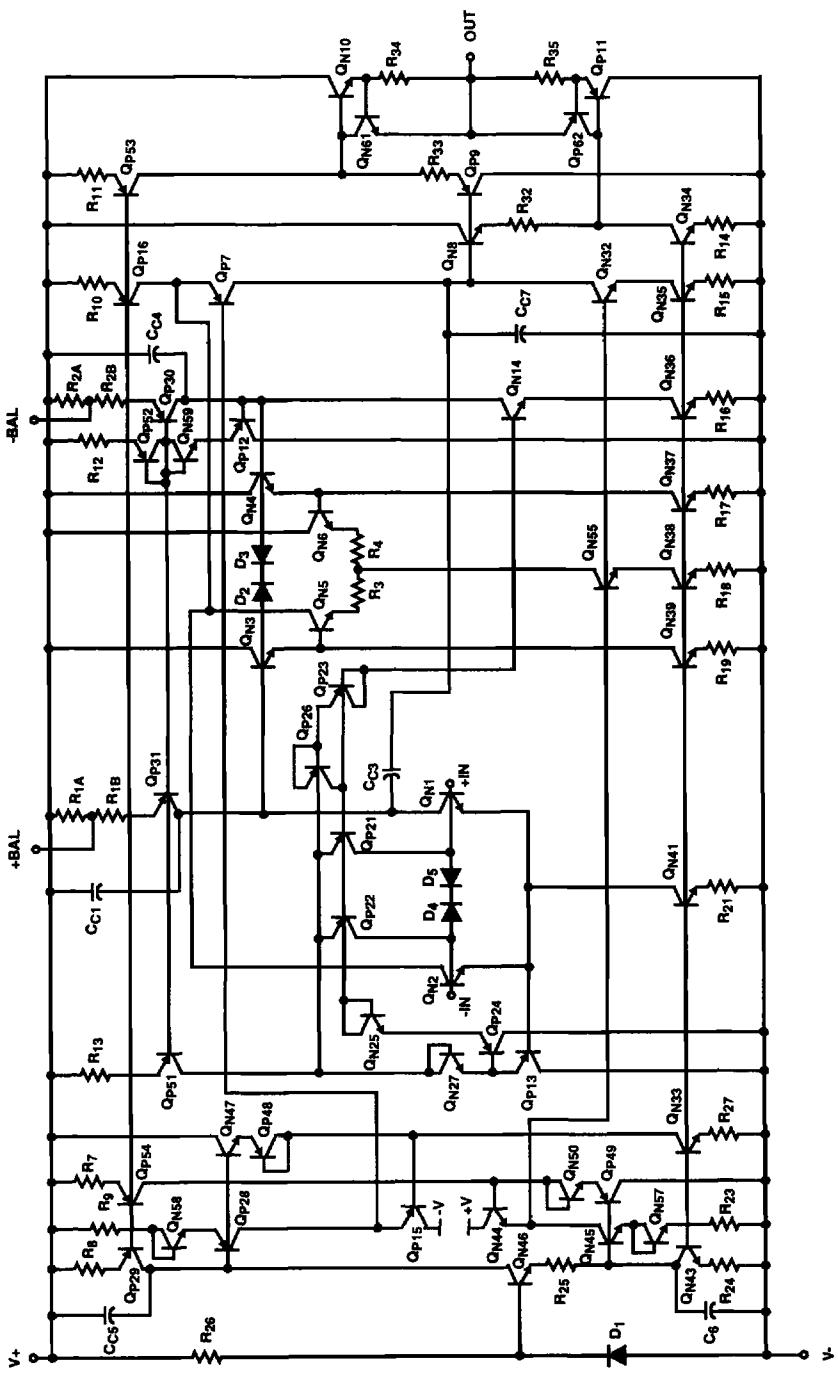

## Application Information

### Operation at Various Supply Voltages

The HA-5221/5222 operates over a wide range of supply voltages with little variation in performance. The supplies may be varied from  $\pm 5V$  to  $\pm 15V$ . See typical performance curves for variations in supply current, slew rate and output voltage swing.

### Offset Adjustment

The following diagram shows the offset voltage adjustment configuration for the HA-5221. By moving the potentiometer wiper towards pin 8 (+BAL), the op amp's output voltage will increase; towards pin 1 (-BAL) decreases the output voltage. A 20k $\Omega$  trim pot will allow an offset voltage adjustment of about 10mV.

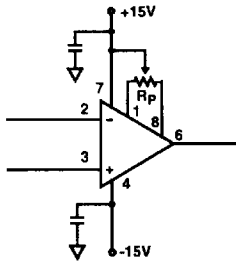

### Capacitive Loading Considerations

When driving capacitive loads  $>80pF$ , a small resistor, 50 $\Omega$  to 100 $\Omega$ , should be connected in series with the output and inside the feedback loop.

### Saturation Recovery

When an op amp is over driven, output devices can saturate and sometimes take a long time to recover. By clamping the input, output saturation can be avoided. If output saturation can not be avoided, the maximum recovery time when over-driven into the positive rail is 10.6 $\mu s$ . When driven into the negative rail the maximum recovery time is 3.8 $\mu s$ .

### Input Protection

The HA-5221/5222 has built in back-to-back protection diodes which limit the maximum allowable differential input voltage to approximately 5V. If the HA-5221/5222 will be used in circuits where the maximum differential voltage may be exceeded, then current limiting resistors must be used. The input current should be limited to a maximum of 10mA.

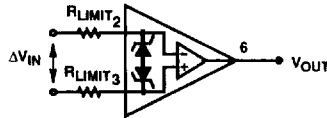

### PC Board Layout Guidelines

When designing with the HA-5221 or the HA-5222, good high frequency (RF) techniques should be used when building a PC board. Use of ground plane is recommended. Power supply decoupling is very important. A 0.01 $\mu F$  to 0.1 $\mu F$  high quality ceramic capacitor at each power supply pin with a 2.2 $\mu F$  to 10 $\mu F$  tantalum close by will provide excellent decoupling. Chip capacitors produce the best results due to ease of placement next to the op amp and basically no lead inductance. If leaded capacitors are used, the leads should be kept as short as possible to minimize lead inductance.

## Typical Performance Curves $V_S = \pm 15V, T_A = 25^\circ C$

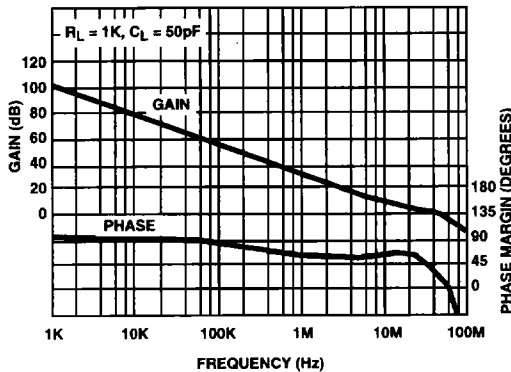

FIGURE 5. OPEN LOOP GAIN AND PHASE vs FREQUENCY

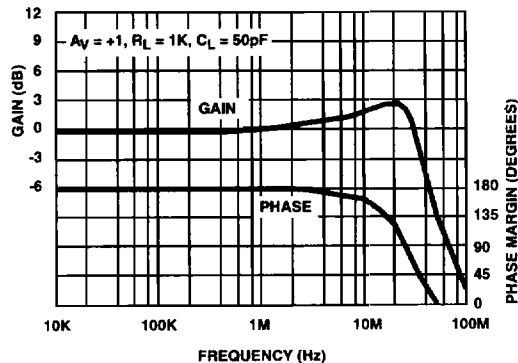

FIGURE 6. CLOSED LOOP GAIN vs FREQUENCY

Typical Performance Curves  $V_S = \pm 15V$ ,  $T_A = 25^\circ C$  (Continued)

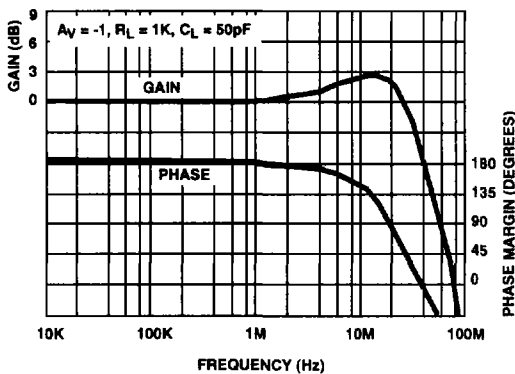

FIGURE 7. CLOSED LOOP GAIN vs FREQUENCY

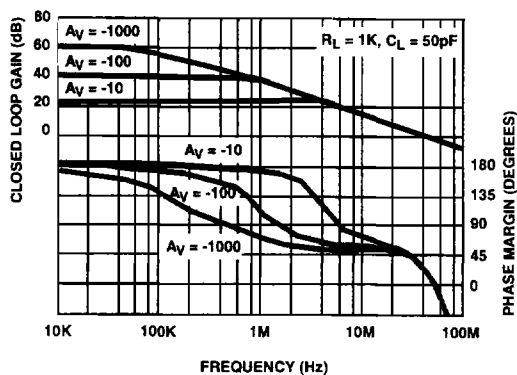

FIGURE 8. VARIOUS CLOSED LOOP GAINS vs FREQUENCY

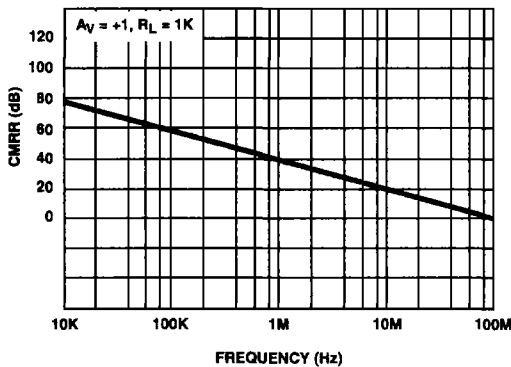

FIGURE 9. CMRR vs FREQUENCY

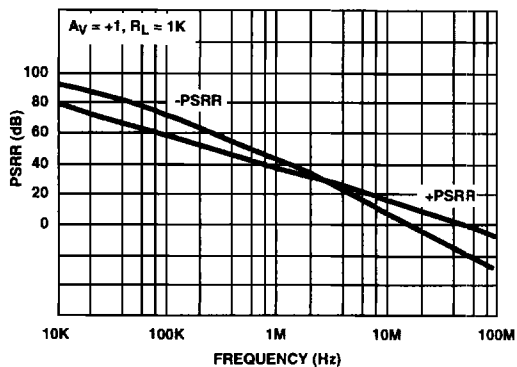

FIGURE 10. PSRR vs FREQUENCY

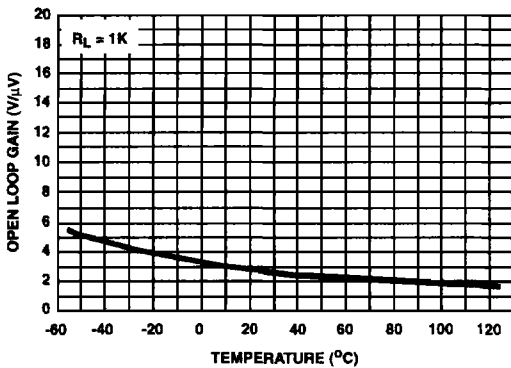

FIGURE 11. OPEN LOOP GAIN vs TEMPERATURE

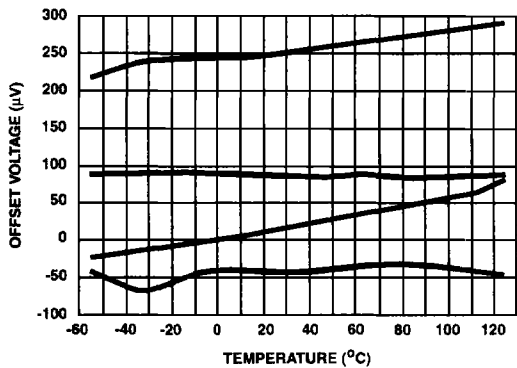

FIGURE 12. OFFSET VOLTAGE vs TEMPERATURE  
(4 REPRESENTATIVE UNITS)

Typical Performance Curves  $V_S = \pm 15V, T_A = 25^\circ C$  (Continued)

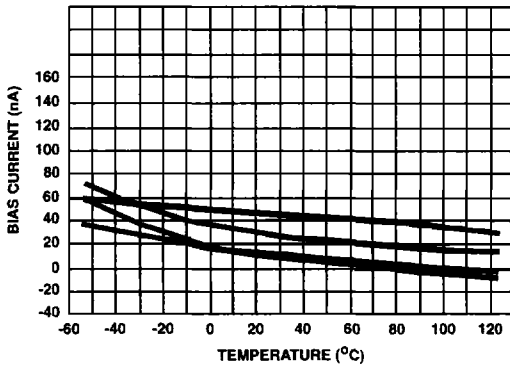

FIGURE 13. BIAS CURRENT vs TEMPERATURE (4 REPRESENTATIVE UNITS)

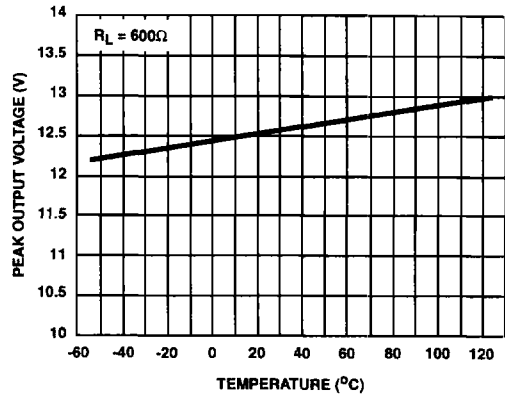

FIGURE 14. OUTPUT VOLTAGE SWING vs TEMPERATURE

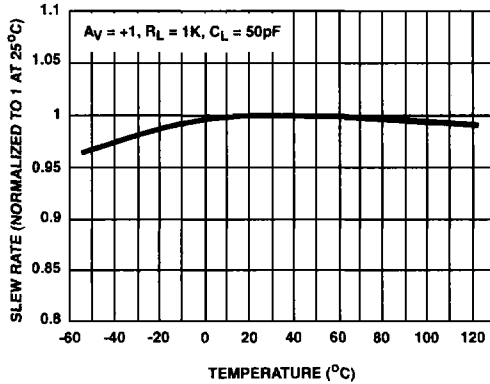

FIGURE 15. SLEW RATE vs TEMPERATURE

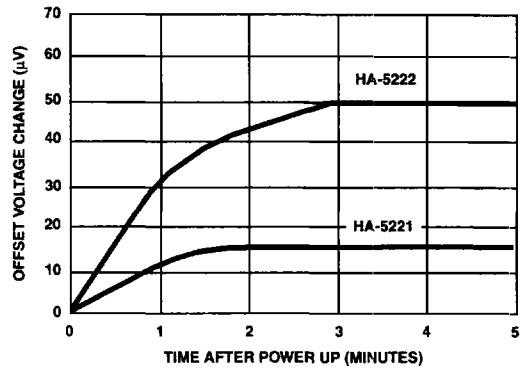

FIGURE 16. OFFSET VOLTAGE WARM-UP DRIFT (CERDIP PACKAGES)

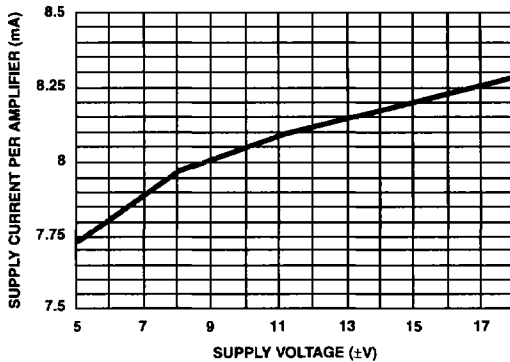

FIGURE 17. SUPPLY CURRENT vs SUPPLY VOLTAGE

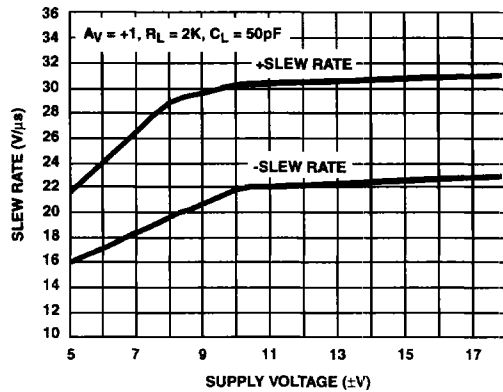

FIGURE 18. SLEW RATE vs SUPPLY VOLTAGE



Typical Performance Curves  $V_S = \pm 15V, T_A = 25^\circ C$  (Continued)

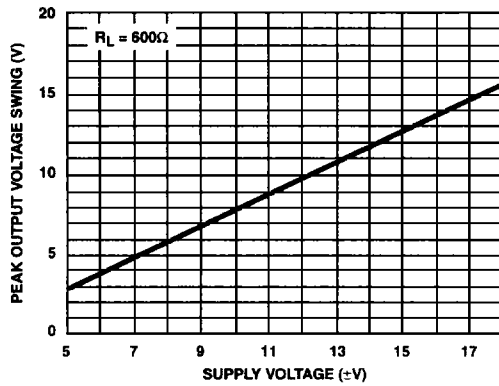

FIGURE 19. OUTPUT VOLTAGE SWING vs SUPPLY VOLTAGE

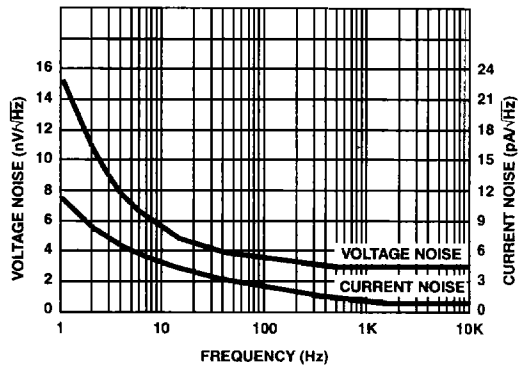

FIGURE 20. NOISE CHARACTERISTICS

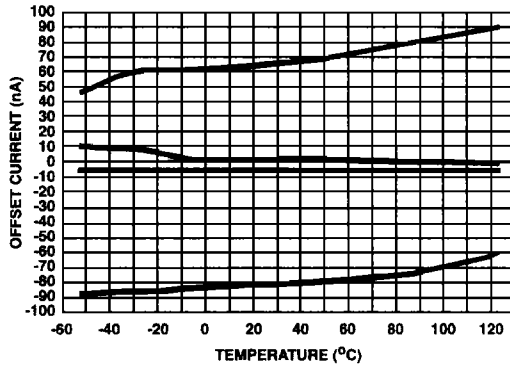

FIGURE 21. OFFSET CURRENT vs TEMPERATURE (4 REPRESENTATIVE UNITS)

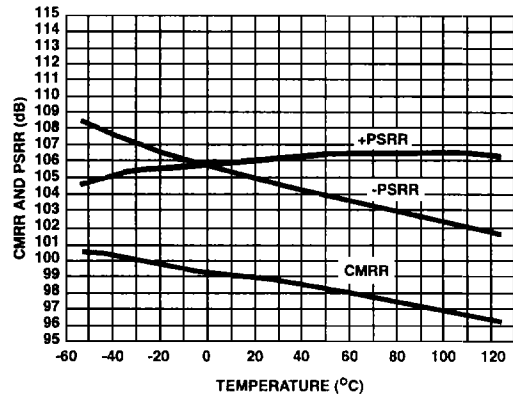

FIGURE 22. CMRR AND PSRR vs TEMPERATURE

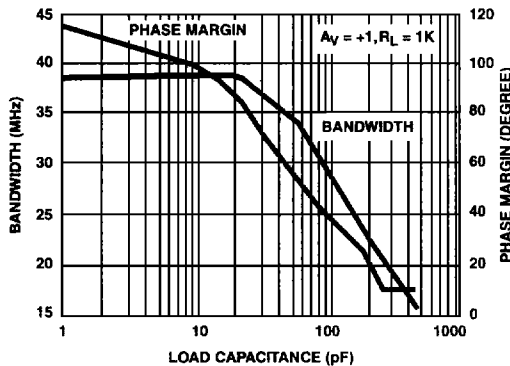

FIGURE 23. BANDWIDTH AND PHASE MARGIN vs LOAD CAPACITANCE

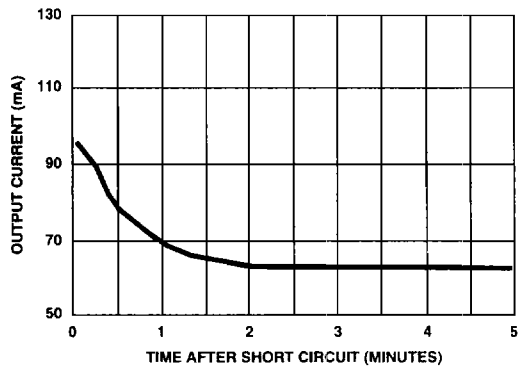
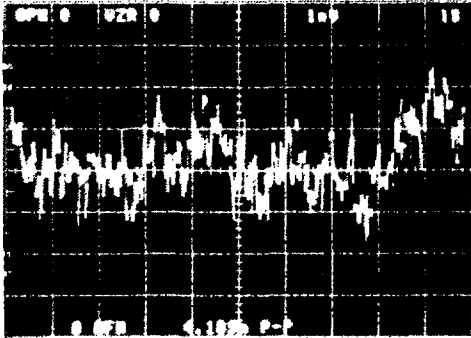

FIGURE 24. SHORT CIRCUIT OUTPUT CURRENT vs TIME

Typical Performance Curves  $V_S = \pm 15V$ ,  $T_A = 25^\circ C$  (Continued)



Vertical Scale = 1mV/Div.; Horizontal Scale = 1s/Div.  
 $A_V = +25,000$ ;  $E_N = 0.168\mu V_{p-p}$  RTI

FIGURE 25. 0.1Hz TO 10Hz NOISE

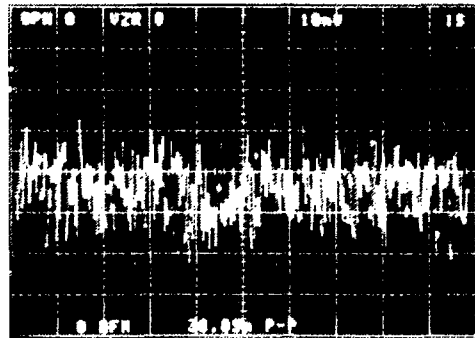

Vertical Scale = 10mV/Div.; Horizontal Scale = 1s/Div.  
 $A_V = +25,000$ ;  $E_N = 1.5\mu V_{p-p}$  RTI

FIGURE 26. 0.1Hz TO 1MHz

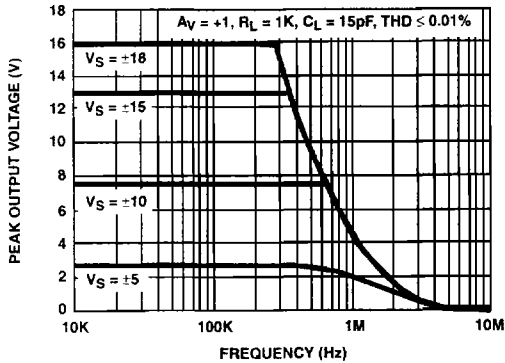

FIGURE 27. OUTPUT VOLTAGE SWING vs FREQUENCY

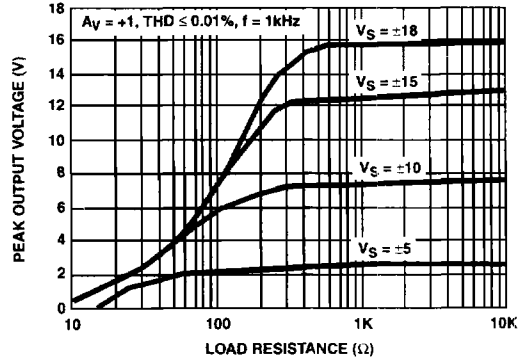

FIGURE 28. OUTPUT VOLTAGE SWING vs LOAD RESISTANCE

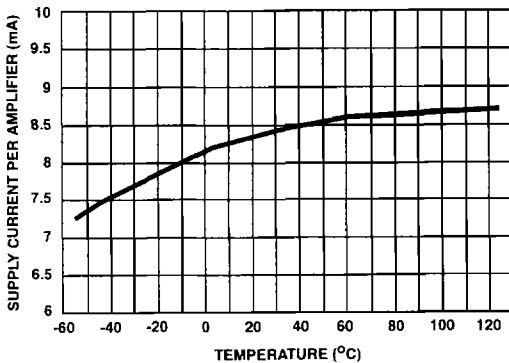

FIGURE 29. SUPPLY CURRENT/AMPLIFIER vs TEMPERATURE

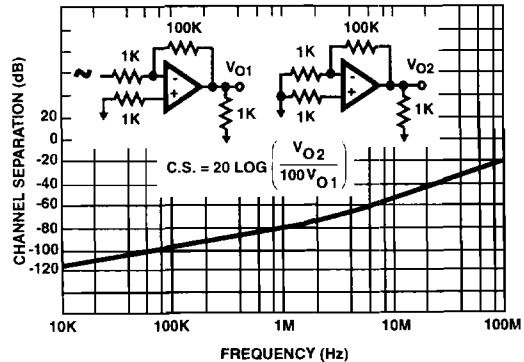

FIGURE 30. CHANNEL SEPARATION vs FREQUENCY  
 (HA-5222 ONLY)



## HA-5221, HA-5222

### Die Characteristics

#### DIE DIMENSIONS:

78 mils x 185 mils x 19 mils  
1980 $\mu$ m x 4690 $\mu$ m x 483 $\mu$ m

#### METALLIZATION:

Type: Al, 1% Cu  
Thickness: 16k $\text{\AA}$   $\pm$  2k $\text{\AA}$

#### PASSIVATION:

Type: Nitride (Si<sub>3</sub>N<sub>4</sub>) over Silox (SiO<sub>2</sub> 5% Phos.)  
Silox Thickness: 12k $\text{\AA}$   $\pm$  2k $\text{\AA}$   
Nitride Thickness: 3.5k $\text{\AA}$   $\pm$  1.5k $\text{\AA}$

#### SUBSTRATE POTENTIAL (Powered Up):

V-

#### TRANSISTOR COUNT:

128

#### PROCESS:

Bipolar Dielectric Isolation

### Metallization Mask Layout

