

CA1558

Single and Dual, High Gain Operational Amplifiers for Military, Industrial, and Commercial Applications

The CA1458, CA1558 (dual types); CA741C, CA741 (single types); high-gain operational amplifiers for use in military, industrial, and commercial applications.

These monolithic silicon integrated circuit devices provide output short circuit protection and latch-free operation. These types also feature wide common mode and differential mode signal ranges and have low offset voltage nulling capability when used with an appropriately valued potentiometer. A 10k Ω potentiometer is used for offset nulling types CA741C, CA741. Types CA1458, CA1558 have no specific terminals for offset nulling. Each type consists of a differential input amplifier that effectively drives a gain and level shifting stage having a complementary emitter follower output.

Rochester Electronics Manufactured Components

Rochester branded components are manufactured using either die/wafers purchased from the original suppliers or Rochester wafers recreated from the original IP. All re-creations are done with the approval of the Original Component Manufacturer (OCM).

Parts are tested using original factory test programs or Rochester developed test solutions to guarantee product meets or exceeds the OCM data sheet.

Quality Overview

- ISO-9001
- AS9120 certification
- Qualified Manufacturers List (QML) MIL-PRF-35835
 - Class Q Military
 - Class V Space Level
- Qualified Suppliers List of Distributors (QSLD)
 - Rochester is a critical supplier to DLA and meets all industry and DLA standards.

Rochester Electronics, LLC is committed to supplying products that satisfy customer expectations for quality and are equal to those originally supplied by industry manufacturers.

The original manufacturer's datasheet accompanying this document reflects the performance and specifications of the Rochester manufactured version of this device. Rochester Electronics guarantees the performance of its semiconductor products to the original OCM specifications. 'Typical' values are for reference purposes only. Certain minimum or maximum ratings may be based on product characterization, design, simulation, or sample testing.

FOR REFERENCE ONLY

Single and Dual, High Gain Operational Amplifiers for Military, Industrial and Commercial Applications

November 1996

Features

- Input Bias Current 500nA (Max)
- Input Offset Current 200nA (Max)

Applications

- Comparator
- DC Amplifier
- Integrator or Differentiator
- Multivibrator
- Summing Amplifier
- Narrow Band or Band Pass Filter

Ordering Information

PART NUMBER	TEMP. RANGE (°C)	PACKAGE	PKG. NO.
CA0741E	-55 to 125	8 Ld PDIP	E8.3
CA0741CE	0 to 70	8 Ld PDIP	E8.3
CA1458E	0 to 70	8 Ld PDIP	E8.3
CA1558E	-55 to 125	8 Ld PDIP	E8.3
CA0741T	-55 to 125	8 Pin Metal Can	T8.C
CA0741CT	0 to 70	8 Pin Metal Can	T8.C
CA1458T	0 to 70	8 Pin Metal Can	T8.C
CA1558T	-55 to 125	8 Pin Metal Can	T8.C
LM741N	-55 to 125	8 Ld PDIP	E8.3
LM741CN	0 to 70	8 Ld PDIP	E8.3
LM741H	-55 to 125	8 Pin Metal Can	T8.C
LM741CH	0 to 70	8 Pin Metal Can	T8.C
LM1458N	0 to 70	8 Ld PDIP	E8.3

Description

The CA1458, CA1558 (dual types); CA741C, CA741 (single types); high-gain operational amplifiers for use in military, industrial, and commercial applications.

These monolithic silicon integrated circuit devices provide output short circuit protection and latch-free operation. These types also feature wide common mode and differential mode signal ranges and have low offset voltage nulling capability when used with an appropriately valued potentiometer. A 10kΩ potentiometer is used for offset nulling types CA741C, CA741 (see Figure 1). Types CA1458, CA1558 have no specific terminals for offset nulling. Each type consists of a differential input amplifier that effectively drives a gain and level shifting stage having a complementary emitter follower output.

The manufacturing process make it possible to produce IC operational amplifiers with low burst "popcorn" noise characteristics. The CA741 gives limit specifications for burst noise in the data bulletin, File Number 530. Contact your Sales Representative for information pertinent to other operational amplifier types that meet low burst noise specifications.

Technical Data on LM Branded types is identical to the corresponding CA Branded types.

Pinouts

CA741, CA741C, LM741, LM741C (CAN)
TOP VIEW

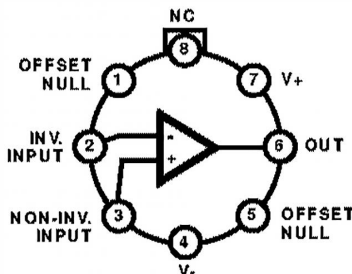

CA741, CA741C, LM741, LM741C (PDIP)
TOP VIEW

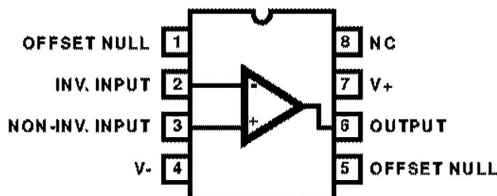

CA1458, CA1558 (METAL CAN)
TOP VIEW

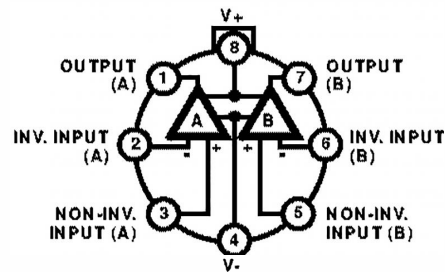

CA1458, CA1558, LM1458 (PDIP)
TOP VIEW

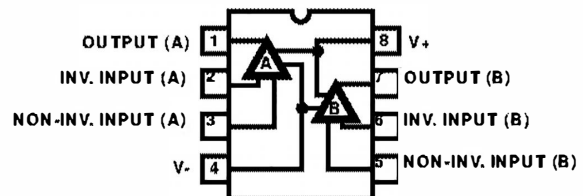

CA741, CA741C, CA1458, CA1558, LM741, LM741C, LM1458

Absolute Maximum Ratings

Supply Voltage	
CA741C, CA1458, LM741C, LM1458 (Note 1)	36V
CA741, CA1558, LM741 (Note 1)	44V
Differential Input Voltage	30V
Input Voltage	$\pm V_{SUPPLY}$
Offset Terminal to V- Terminal Voltage (CA741C, CA741)	$\pm 0.5V$
Output Short Circuit Duration	Indefinite

Thermal Information

Thermal Resistance (Typical, Note 3)	θ_{JA} (°C/W)	θ_{JC} (°C/W)
PDIP Package	130	N/A
Can Package	155	67
Maximum Junction Temperature (Can Package)	175°C	
Maximum Junction Temperature (Plastic Package)	150°C	
Maximum Storage Temperature Range	-65°C to 150°C	
Maximum Lead Temperature (Soldering 10s)	300°C	

Operating Conditions

Temperature Range	
CA741, CA1558, LM741	-55°C to 125°C
CA741C, CA1458, LM741C, LM1458 (Note 2)	0°C to 70°C

CAUTION: Stresses above those listed in "Absolute Maximum Ratings" may cause permanent damage to the device. This is a stress only rating and operation of the device at these or any other conditions above those indicated in the operational sections of this specification is not implied.

NOTES:

- Values apply for each section of the dual amplifiers.
- All types in any package style can be operated over the temperature range of -55°C to 125°C, although the published limits for certain electrical specification apply only over the temperature range of 0°C to 70°C.
- θ_{JA} is measured with the component mounted on an evaluation PC board in free air.

Electrical Specifications Typical Values Intended Only for Design Guidance, $V_{SUPPLY} = \pm 15V$

PARAMETER	SYMBOL	TEST CONDITIONS	TYPICAL VALUE (ALL TYPES)	UNITS
Input Capacitance	C_I		1.4	pF
Offset Voltage Adjustment Range			± 15	mV
Output Resistance	R_O		75	Ω
Output Short Circuit Current			25	mA
Transient Response		Unity Gain, $V_I = 20mV$, $R_L = 2k\Omega$, $C_L \leq 100pF$		
Rise Time	t_r		0.3	μs
Overshoot	O.S.		5.0	%
Slew Rate (Closed Loop)	SR	$R_L \geq 2k\Omega$	0.5	V/ μs

Electrical Specifications For Equipment Design, $V_{SUPPLY} = \pm 15V$

PARAMETER	TEST CONDITIONS	TEMP (°C)	(NOTE 4) CA741, CA1558, LM741			(NOTE 4) CA741C, CA1458, LM741C, LM1458			UNITS
			MIN	TYP	MAX	MIN	TYP	MAX	
Input Offset Voltage	$R_S \leq 10k\Omega$	25	-	1	5	-	2	6	mV
		Full	-	1	6	-	-	7.5	mV
Input Common Mode Voltage Range		25	-	-	-	$\pm 12V$	$\pm 13V$	-	V
		Full	$\pm 12V$	$\pm 13V$	-	-	-	-	V
Common Mode Rejection Ratio	$R_S \leq 10k\Omega$	25	-	-	-	70	90	-	dB
		Full	70	90	-	-	-	-	dB
Power Supply Rejection Ratio	$R_S \leq 10k\Omega$	25	-	-	-	-	30	150	$\mu V/V$
		Full	-	30	150	-	-	-	$\mu V/V$
Input Resistance		25	0.3	2	-	0.3	2	-	M Ω

CA741, CA741C, CA1458, CA1558, LM741, LM741C, LM1458

Electrical Specifications For Equipment Design, $V_{SUPPLY} = \pm 15V$ (Continued)

PARAMETER	TEST CONDITIONS	TEMP (°C)	(NOTE 4) CA741, CA1558, LM741			(NOTE 4) CA741C, CA1458, LM741C, LM1458			UNIT S
			MIN	TYP	MAX	MIN	TYP	MAX	
			Input Bias Current		25	-	80	500	
		Full	-	-	-	-	-	800	nA
		-55	-	300	1500	-	-	-	nA
		125	-	30	500	-	-	-	nA
Input Offset Current		25	-	20	200	-	20	200	nA
		Full	-	-	-	-	-	300	nA
		-55	-	85	500	-	-	-	nA
		125	-	7	200	-	-	-	nA
Large Signal Voltage Gain	$R_L \geq 2k\Omega, V_O = \pm 10V$	25	50,000	200,000	-	20,000	200,000	-	V/V
		Full	25,000	-	-	15,000	-	-	V/V
Output Voltage Swing	$R_L \geq 10k\Omega$	25	-	-	-	$\pm 12V$	$\pm 14V$	-	V
		Full	$\pm 12V$	$\pm 14V$	-	-	-	-	
	$R_L \geq 2k\Omega$	25	-	-	-	$\pm 10V$	$\pm 13V$	-	V
		Full	$\pm 10V$	$\pm 13V$	-	$\pm 10V$	$\pm 13V$	-	
Supply Current		25	-	1.7	2.8	-	1.7	2.8	mA
		-55	-	2	3.3	-	-	-	mA
		125	-	1.5	2.5	-	-	-	mA
Device Power Dissipation		25	-	50	85	-	50	85	mW
		-55	-	60	100	-	-	-	mW
		125	-	45	75	-	-	-	mW

NOTE:

- 4. Values apply for each section of the dual amplifiers.

Test Circuits

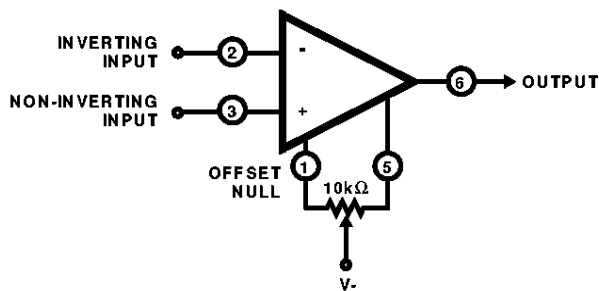

FIGURE 1. OFFSET VOLTAGE NULL CIRCUIT FOR CA741C, CA741, LM741C, AND LM741

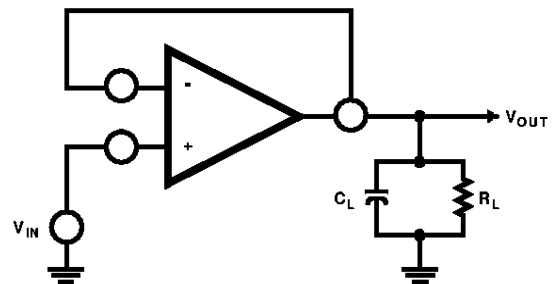
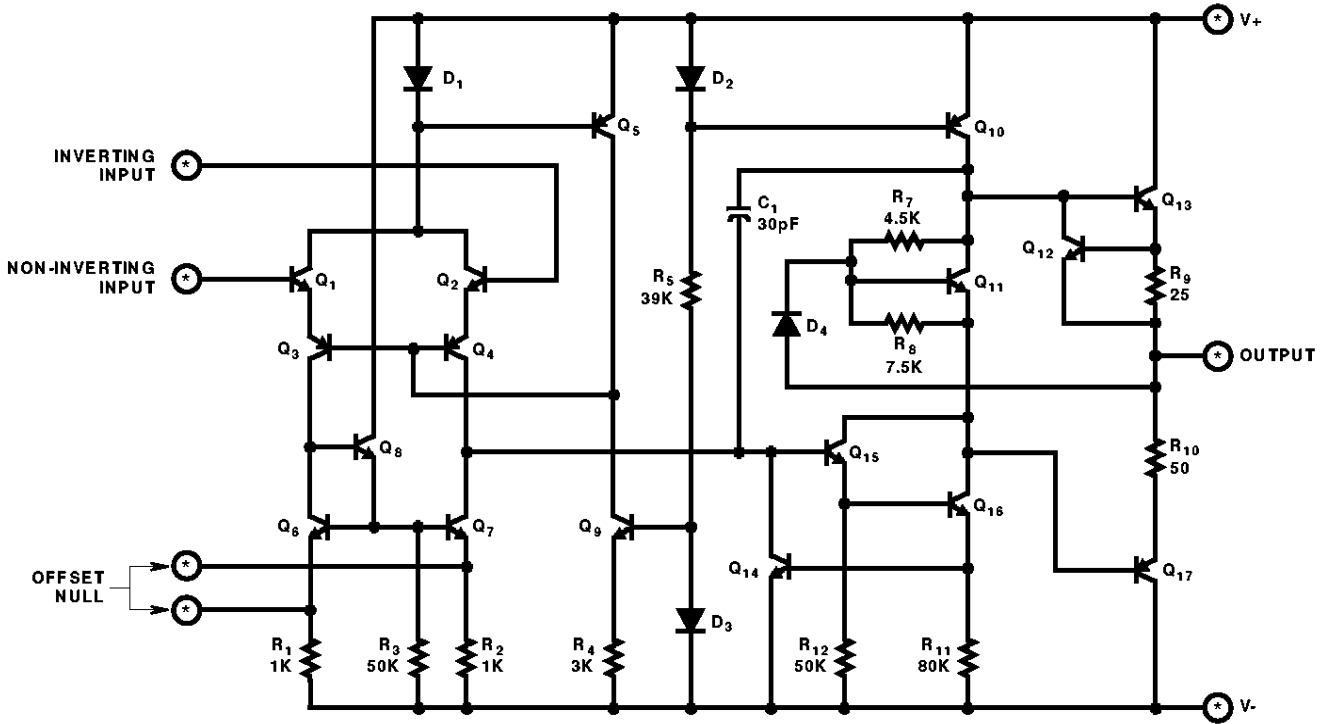

FIGURE 2. TRANSIENT RESPONSE TEST CIRCUIT FOR ALL TYPES

Schematic Diagram (Notes 5, 6)

CA741C, CA741, LM741C, LM741 AND FOR EACH AMPLIFIER OF THE CA1458, CA1558, AND LM1458



NOTES:

- 5. See Pinouts for Terminal Numbers of Respective Types.
- 6. All Resistance Values are in Ohms.

Typical Performance Curves

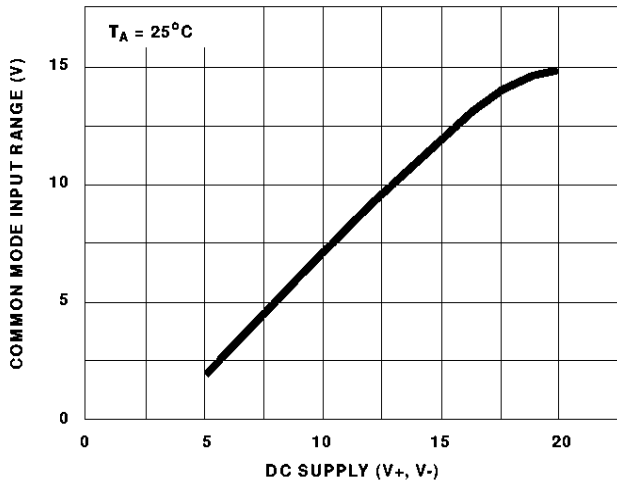

FIGURE 3. COMMON MODE INPUT VOLTAGE RANGE vs SUPPLY VOLTAGE FOR ALL TYPES

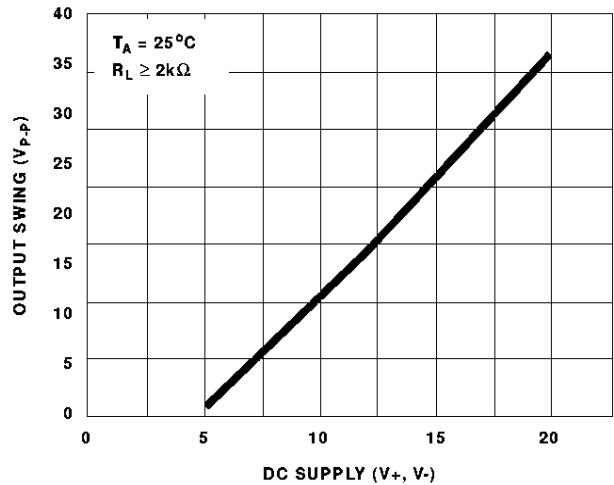

FIGURE 4. OUTPUT VOLTAGE vs SUPPLY VOLTAGE FOR ALL TYPES

Typical Performance Curves (Continued)

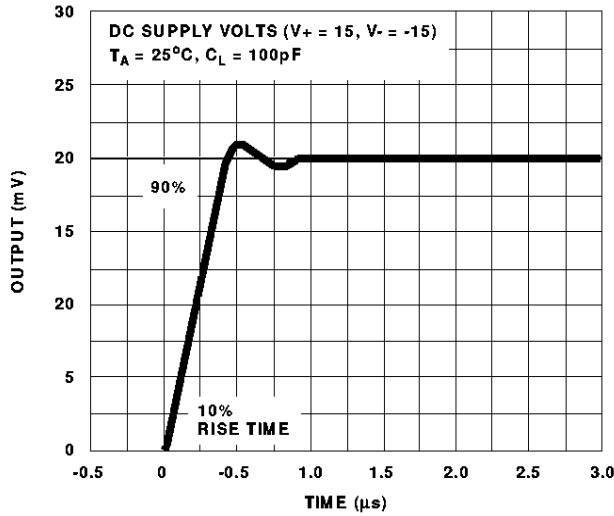
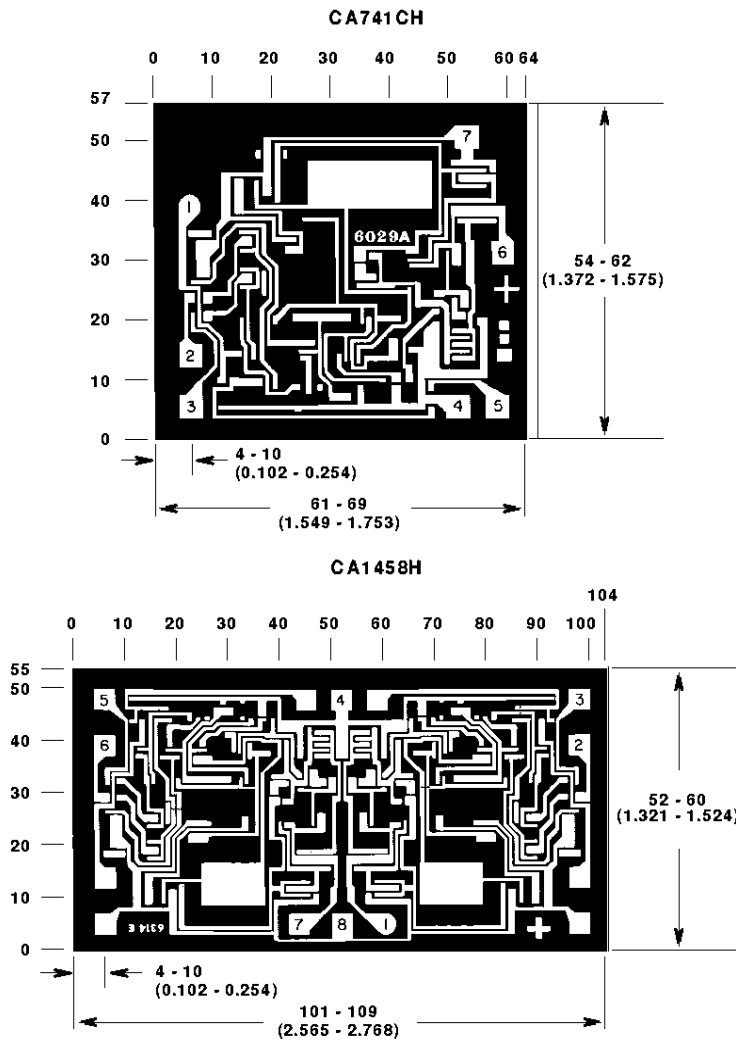

FIGURE 5. TRANSIENT RESPONSE FOR CA741C AND CA741

Metallization Mask Layout



NOTE: Dimensions in parentheses are in millimeters and are derived from the basic inch dimensions as indicated. Grid graduations are in mils (10^{-3} inch).