

# 10-Ampere P-N-P Darlington Power Transistors

40-60-80 Volts, 70 Watts  
Gain of 1000 at 5 A

**Features:**

- Operates from IC without predriver

**Applications:**

- Power switching
- Audio amplifiers
- Hammer drivers
- Series and shunt regulators

**TERMINAL DESIGNATIONS**

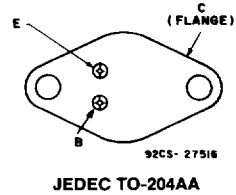

The 2N6648, 2N6649 and 2N6650<sup>●</sup> are monolithic silicon p-n-p Darlington transistors designed for low- and medium-frequency power applications. The high gain of these devices makes it possible for them to be driven directly from integrated circuits. They are complementary to the 2N6383, 2N6384, and 2N6385<sup>▲</sup>.

The 2N6648, 2N6649, and 2N6650 are supplied in hermetic steel JEDEC TO-204AA packages.

<sup>●</sup> Formerly RCA Dev. Nos. TA8351, TA8488, and TA8350, respectively.

<sup>▲</sup> Technical data for 2N6383, 2N6384, and 2N6385 are given in RCA bulletin File No. 609.

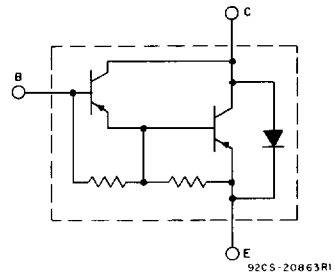

Fig. 1 — Schematic diagram for all types.

**MAXIMUM RATINGS, Absolute-Maximum Values:**

	2N6648	2N6649	2N6650	
* $V_{CBO}$ .....	-40	-60	-80	V
$V_{CER}$ (sus) $R_{BE} = 100 \Omega$ .....	-40	-60	-80	V
* $V_{CEO}$ (sus) .....	-40	-60	-80	V
$V_{CEV}$ (sus) $V_{BE} = -1.5 V$ .....	-40	-60	-80	V
* $V_{EBO}$ .....	-5	-5	-5	V
* $I_C$ .....	-10	-10	-10	A
$I_{CM}$ .....	-15	-15	-15	A
* $I_B$ .....	-0.25	-0.25	-0.25	A
* $P_T$ $T_C \leq 25^\circ C$ .....	70	70	70	W
$T_C > 25^\circ C$ .....	Derate linearly		0.56	W/ $^\circ C$
* $T_{stg}, T_J$ .....	-65 to +150			$^\circ C$
* $T_L$ At distances $\geq 1/32$ in. (0.8 mm) from seating plane for 10 s max. ....	235			$^\circ C$

\* In accordance with JEDEC registration data format (JS-6 RDF-4)

# 2N6648, 2N6649, 2N6650

ELECTRICAL CHARACTERISTICS, At Case Temperature ( $T_C$ ) = 25°C Unless Otherwise Specified

CHARACTERISTIC	TEST CONDITIONS				LIMITS					UNITS	
	VOLTAGE V dc		CURRENT A dc		2N6648		2N6649		2N6650		
	V <sub>CE</sub>	V <sub>BE</sub>	I <sub>C</sub>	I <sub>B</sub>	MIN.	MAX.	MIN.	MAX.	MIN.		MAX.
I <sub>CEO</sub>	-40 -60 -80			0 0 0	- - -	-1 - -	- - -	- -1 -	- - -	- - -1	mA
* I <sub>CEV</sub>	-40 -60 -80	1.5 1.5 1.5			- - -	-0.3 - -	- - -	- -0.3 -	- - -	- - -0.3	
$T_C = 150^\circ\text{C}$	-40 -60 -80	1.5 1.5 1.5			- - -	-3 - -	- - -	- -3 -	- - -	- - -3	
* I <sub>EBO</sub>		5	0		-	-10	-	-10	-	-10	mA
* V <sub>CEO(sus)</sub>			-0.2 <sup>a</sup>	0	-40	-	-60	-	-80	-	V
V <sub>CE(sus)</sub> R <sub>BE</sub> = 100 Ω			-0.2 <sup>a</sup>		-40	-	-60	-	-80	-	
V <sub>CEV(sus)</sub>		1.5	-0.2 <sup>a</sup>		-40	-	-60	-	-80	-	
* h <sub>FE</sub>	-3 -3		-5 <sup>a</sup> -10 <sup>a</sup>		1000 100	20,000 100	1000 100	20,000 100	1000 100	20,000 100	
V <sub>BE</sub>	-3 -3		-5 <sup>a</sup> -10 <sup>a</sup>		-	-2.8 -4.5*	-	-2.8 -4.5*	-	-2.8 -4.5*	V
V <sub>CE(sat)</sub>			-5 <sup>a</sup> -10 <sup>a</sup>	-0.01 <sup>a</sup> -0.1 <sup>a</sup>	-	-2 -3*	-	-2 -3*	-	-2 -3*	V
V <sub>F</sub>			10 <sup>a</sup>		-	4	-	4	-	4	V
h <sub>fe</sub> f = 1 kHz	-5		-1		1000	-	1000	-	1000	-	
*  h <sub>fe</sub>   f = 1 MHz	-5		-1		20	-	20	-	20	-	
I <sub>S/b</sub> t = 1 s, nonrep.	-35 -25				-1 -2.8	-	-1 -2.8	-	-1 -2.8	-	A
R <sub>θJC</sub>					-	1.75	-	1.75	-	1.75	°C/W

\* In accordance with JEDEC registration data format (JS-6 RDF-4).

<sup>a</sup> Pulsed: Pulse duration = 300 μs, duty factor = 1.8%.

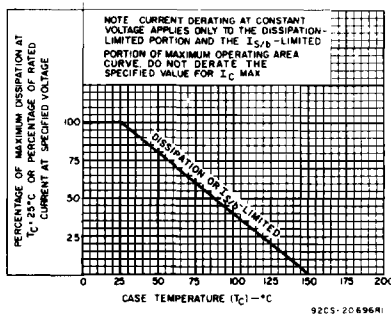

Fig. 2 - Derating curve for all types.

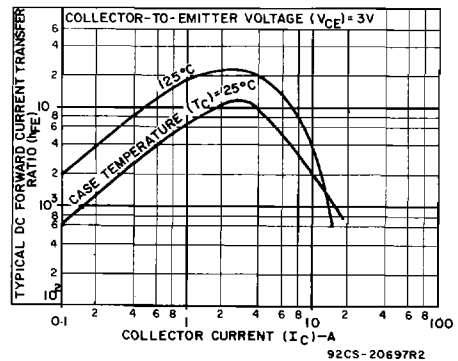

Fig. 3 - Typical dc beta characteristics for all types.

2  
POWER TRANSISTORS

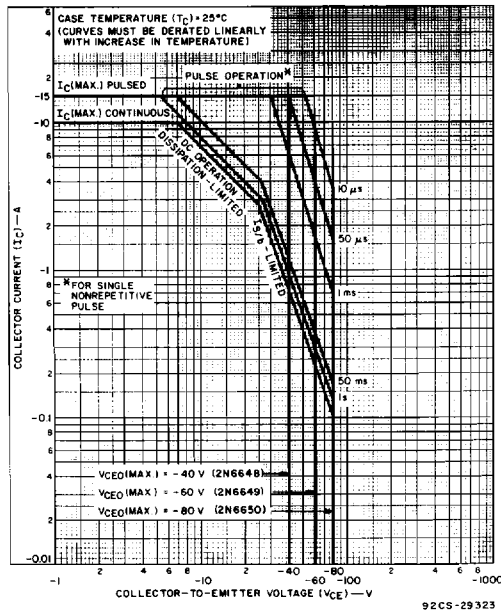

Fig. 4 — Maximum operating areas for all types.

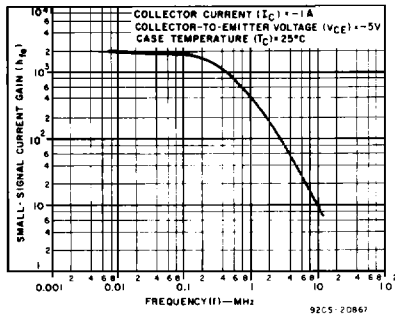

Fig. 5 — Typical small-signal gain for all types.

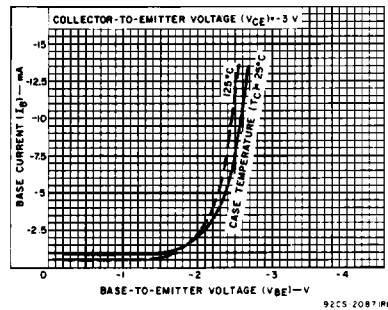

Fig. 6 — Typical input characteristics for all types.

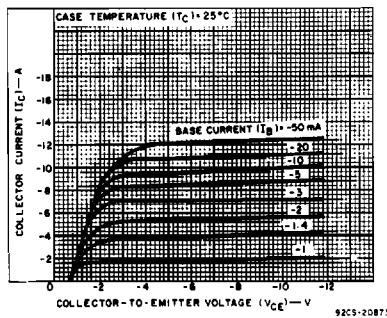

Fig. 7 — Typical output characteristics for all types.

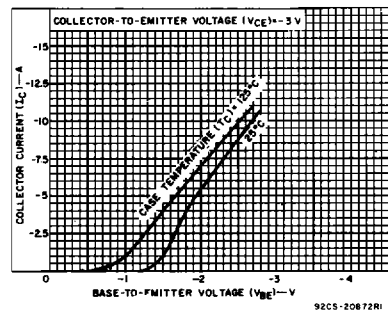

Fig. 8 — Typical transfer characteristics for all types.

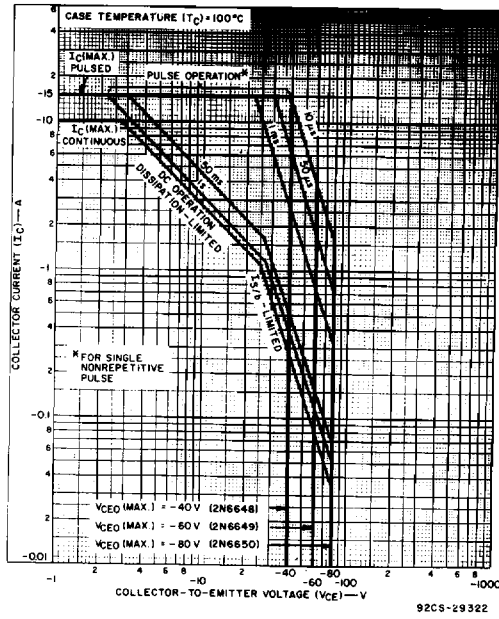

Fig. 9 — Maximum operating areas for all types at  $T_c = 100^\circ C$ .

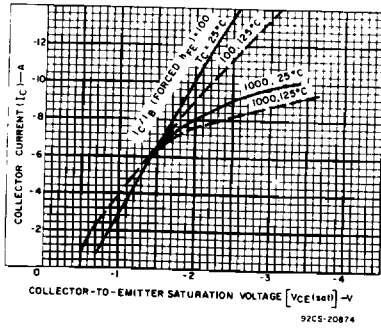

Fig. 10 — Typical saturation characteristics for all types.

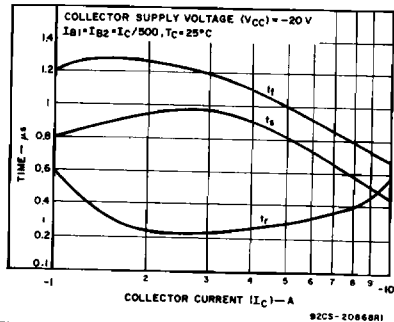

Fig. 12 — Typical saturated switching-time characteristics for all types.

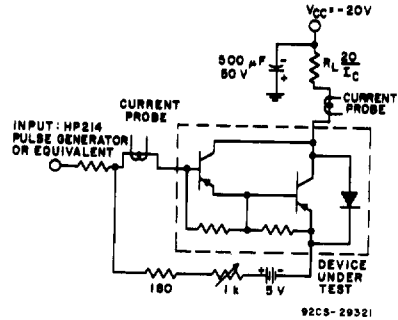

Fig. 11 — Circuit used to measure saturated switching times.

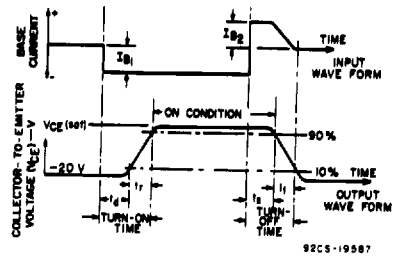

Fig. 13 — Phase relationship between input current and output current showing reference points for specification of switching times.