

# Dual Bias Resistor Transistors

## PNP Silicon Surface Mount Transistors with Monolithic Bias Resistor Network

The BRT (Bias Resistor Transistor) contains a single transistor with a monolithic bias network consisting of two resistors; a series base resistor and a base-emitter resistor. These digital transistors are designed to replace a single device and its external resistor bias network. The BRT eliminates these individual components by integrating them into a single device. In the LMUN5111DW1T1G series, two BRT devices are housed in the SOT-363 package which is ideal for low-power surface mount applications where board space is at a premium.

- . Simplifies Circuit Design
- . Reduces Board Space
- . Reduces Component Count
- . Available in 8 mm, 7 inch/3000 Unit Tape and Reel
- . We declare that the material of product compliance with RoHS requirements.
- . S - Prefix for Automotive and Other Applications Requiring Unique Site and Control Change Requirements; AEC-Q101 Qualified and PPAP Capable.

**LMUN5111DW1T1G  
Series  
S-LMUN5111DW1T1G  
Series**

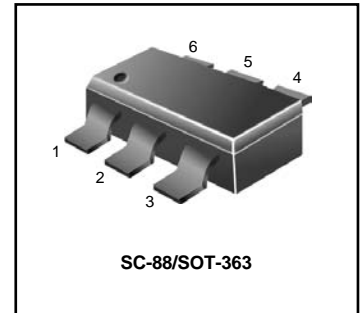

### Ordering Information

Device	Package	Shipping
LMUN5111DW1T1G Series S-LMUN5111DW1T1G Series	SC-88 SC-88	3000/Tape&Reel
LMUN5111DW1T3G Series S-LMUN5111DW1T3G Series	SC-88 SC-88	10000/Tape&Reel

### MAXIMUM RATINGS (T<sub>A</sub> = 25°C unless otherwise noted, common for Q<sub>1</sub> and Q<sub>2</sub>)

Rating	Symbol	Value	Unit
Collector-Base Voltage	V <sub>CBO</sub>	-50	Vdc
Collector-Emitter Voltage	V <sub>CEO</sub>	-50	Vdc
Collector Current	I <sub>C</sub>	-100	mAdc

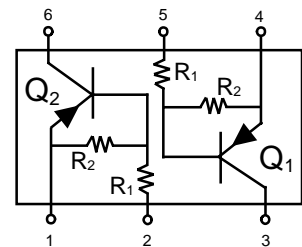

### THERMAL CHARACTERISTICS

Characteristic (One Junction Heated)	Symbol	Max	Unit
Total Device Dissipation T <sub>A</sub> = 25°C	P <sub>D</sub>	187 (Note 1.) 256 (Note 2.)	mW
Derate above 25°C		1.5 (Note 1.) 2.0 (Note 2.)	mW/°C
Thermal Resistance – Junction-to-Ambient	R <sub>θJA</sub>	670 (Note 1.) 490 (Note 2.)	°C/W
Characteristic (Both Junctions Heated)	Symbol	Max	Unit
Total Device Dissipation T <sub>A</sub> = 25°C	P <sub>D</sub>	250 (Note 1.) 385 (Note 2.)	mW
Derate above 25°C		2.0 (Note 1.) 3.0 (Note 2.)	mW/°C
Thermal Resistance – Junction-to-Ambient	R <sub>θJA</sub>	493 (Note 1.) 325 (Note 2.)	°C/W
Thermal Resistance – Junction-to-Lead	R <sub>θJL</sub>	188 (Note 1.) 208 (Note 2.)	°C/W
Junction and Storage Temperature	T <sub>J</sub> , T <sub>stg</sub>	-55 to +150	°C

### MARKING DIAGRAM

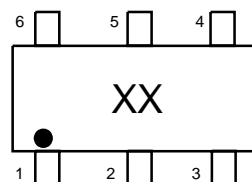

xx = Device Marking  
(See Page 2)

### DEVICE MARKING INFORMATION

See specific marking information in the device marking table on page 2 of this data sheet.

LMUN5111DW1T1G Series  
S-LMUN5111DW1T1G Series

DEVICE MARKING AND RESISTOR VALUES

Device	Package	Marking	R <sub>1</sub> (K)	R <sub>2</sub> (K)	V <sub>IN</sub> (V)	Shipping
LMUN5111DW1T1G	SOT-363	0A	10	10	-10~+40	3000/Tape & Reel
LMUN5112DW1T1G	SOT-363	0B	22	22	-10~+40	3000/Tape & Reel
LMUN5113DW1T1G	SOT-363	0C	47	47	-10~+40	3000/Tape & Reel
LMUN5114DW1T1G	SOT-363	0D	10	47	-6~+40	3000/Tape & Reel
LMUN5115DW1T1G	SOT-363	0E	10	—	-6~+40	3000/Tape & Reel
LMUN5116DW1T1G	SOT-363	0F	4.7	—	-6~+30	3000/Tape & Reel
LMUN5130DW1T1G	SOT-363	0G	1.0	1.0	-10~+10	3000/Tape & Reel
LMUN5131DW1T1G	SOT-363	0H	2.2	2.2	-10~+12	3000/Tape & Reel
LMUN5132DW1T1G	SOT-363	0J	4.7	4.7	-10~+30	3000/Tape & Reel
LMUN5133DW1T1G	SOT-363	0K	4.7	47	-5~+30	3000/Tape & Reel
LMUN5134DW1T1G	SOT-363	0L	22	47	-8~+40	3000/Tape & Reel
LMUN5135DW1T1G	SOT-363	0M	2.2	47	-6~+12	3000/Tape & Reel
LMUN5136DW1T1G	SOT-363	0N	100	100	-10~+40	3000/Tape & Reel
LMUN5137DW1T1G	SOT-363	0P	47	22	-10~+40	3000/Tape & Reel

ELECTRICAL CHARACTERISTICS (T<sub>A</sub> = 25°C unless otherwise noted, common for Q<sub>1</sub> and Q<sub>2</sub>)

Characteristic	Symbol	Min	Typ	Max	Unit
<b>OFF CHARACTERISTICS</b>					
Collector-Base Cutoff Current (V <sub>CB</sub> = -50 V, I <sub>E</sub> = 0)	I <sub>CBO</sub>	-	-	-100	nAdc
Collector-Emitter Cutoff Current (V <sub>CE</sub> = -50 V, I <sub>B</sub> = 0)	I <sub>CEO</sub>	-	-	-500	nAdc
Emitter-Base Cutoff Current (V <sub>EB</sub> = -6.0 V, I <sub>C</sub> = 0)	I <sub>EBO</sub>	-	-	-0.5	mAdc
		-	-	-0.2	
		-	-	-0.1	
		-	-	-0.2	
		-	-	-0.9	
		-	-	-1.9	
		-	-	-4.3	
		-	-	-2.3	
		-	-	-1.5	
		-	-	-0.18	
		-	-	-0.13	
		-	-	-0.2	
		-	-	-0.05	
		-	-	-0.13	
Collector-Base Breakdown Voltage (I <sub>C</sub> = -10 μA, I <sub>E</sub> = 0)	V <sub>(BR)CBO</sub>	-50	-	-	Vdc
Collector-Emitter Breakdown Voltage (Note 3) (I <sub>C</sub> = -2.0 mA, I <sub>B</sub> = 0)	V <sub>(BR)CEO</sub>	-50	-	-	Vdc

3. New resistor combinations. Updated curves to follow in subsequent data sheets.

4. Pulse Test: Pulse Width < 300 μs, Duty Cycle < 2.0%

**LMUN5111DW1T1G Series**  
**S-LMUN5111DW1T1G Series**

**ELECTRICAL CHARACTERISTICS** ( $T_A = 25^\circ\text{C}$  unless otherwise noted, common for Q<sub>1</sub> and Q<sub>2</sub>.) (Continued)

Characteristic	Symbol	Min	Typ	Max	Unit	
<b>ON CHARACTERISTICS</b> (Note 4.)						
Collector-Emitter Saturation Voltage ( $I_C = -10\text{ mA}$ , $I_B = -0.3\text{ mA}$ )	LMUN5111DW1T1G LMUN5112DW1T1G LMUN5113DW1T1G LMUN5114DW1T1G LMUN5135DW1T1G LMUN5136DW1T1G LMUN5137DW1T1G	$V_{CE(sat)}$	-	-	-0.25	Vdc
( $I_C = -10\text{ mA}$ , $I_B = -5\text{ mA}$ )	LMUN5130DW1T1G LMUN5131DW1T1G		-	-	-0.25	
( $I_C = -10\text{ mA}$ , $I_B = -1\text{ mA}$ )	LMUN5115DW1T1G LMUN5116DW1T1G LMUN5132DW1T1G LMUN5133DW1T1G LMUN5134DW1T1G		-	-	-0.25	
DC Current Gain ( $V_{CE} = -10\text{ V}$ , $I_C = -5.0\text{ mA}$ )	LMUN5111DW1T1G LMUN5112DW1T1G LMUN5113DW1T1G LMUN5114DW1T1G LMUN5115DW1T1G LMUN5116DW1T1G LMUN5130DW1T1G LMUN5131DW1T1G LMUN5132DW1T1G LMUN5133DW1T1G LMUN5134DW1T1G LMUN5135DW1T1G LMUN5136DW1T1G LMUN5137DW1T1G	$h_{FE}$	35 60 80 80 160 160 3.0 8.0 15 80 80 80 80 80	60 100 140 140 250 250 5.0 15 27 140 130 140 130 140	- - - - - - - - - - - - - -	
Output Voltage (on) ( $V_{CC} = -5.0\text{ V}$ , $V_B = -2.5\text{ V}$ , $R_L = 1.0\text{ k}\Omega$ )	LMUN5111DW1T1G LMUN5112DW1T1G LMUN5114DW1T1G LMUN5115DW1T1G LMUN5116DW1T1G LMUN5130DW1T1G LMUN5131DW1T1G LMUN5132DW1T1G LMUN5133DW1T1G LMUN5134DW1T1G LMUN5135DW1T1G	$V_{OL}$	-	-	-0.2 -0.2 -0.2 -0.2 -0.2 -0.2 -0.2 -0.2 -0.2 -0.2 -0.2	Vdc
( $V_{CC} = -5.0\text{ V}$ , $V_B = -3.5\text{ V}$ , $R_L = 1.0\text{ k}\Omega$ )	LMUN5113DW1T1G		-	-	-0.2	
( $V_{CC} = -5.0\text{ V}$ , $V_B = -5.5\text{ V}$ , $R_L = 1.0\text{ k}\Omega$ )	LMUN5136DW1T1G		-	-	-0.2	
( $V_{CC} = -5.0\text{ V}$ , $V_B = -4.0\text{ V}$ , $R_L = 1.0\text{ k}\Omega$ )	LMUN5137DW1T1G		-	-	-0.2	
Output Voltage (off) ( $V_{CC} = -5.0\text{ V}$ , $V_B = -0.5\text{ V}$ , $R_L = 1.0\text{ k}\Omega$ )	LMUN5111DW1T1G LMUN5112DW1T1G LMUN5113DW1T1G LMUN5114DW1T1G LMUN5133DW1T1G LMUN5134DW1T1G LMUN5135DW1T1G LMUN5136DW1T1G LMUN5137DW1T1G	$V_{OH}$	-4.9 -4.9 -4.9 -4.9 -4.9 -4.9 -4.9 -4.9 -4.9	- - - - - - - - -	- - - - - - - - -	Vdc
( $V_{CC} = -5.0\text{ V}$ , $V_B = -0.05\text{ V}$ , $R_L = 1.0\text{ k}\Omega$ )	LMUN5130DW1T1G		-4.9	-	-	
( $V_{CC} = -5.0\text{ V}$ , $V_B = -0.25\text{ V}$ , $R_L = 1.0\text{ k}\Omega$ )	LMUN5115DW1T1G LMUN5116DW1T1G LMUN5131DW1T1G LMUN5132DW1T1G		-4.9 -4.9 -4.9 -4.9	- - - -	- - - -	

4. Pulse Test: Pulse Width < 300  $\mu\text{s}$ , Duty Cycle < 2.0%

**LMUN5111DW1T1G Series**  
**S-LMUN5111DW1T1G Series**

**ELECTRICAL CHARACTERISTICS**

(T<sub>A</sub> = 25°C unless otherwise noted, common for Q<sub>1</sub> and Q<sub>2</sub>.) (Continued)

Characteristic	Symbol	Min	Typ	Max	Unit	
<b>ON CHARACTERISTICS</b> (Note 5.)						
Input Resistor	LMUN5111DW1T1G	R <sub>1</sub>	7.0	10	13	k Ω
	LMUN5112DW1T1G		15.4	22	28.6	
	LMUN5113DW1T1G		32.9	47	61.1	
	LMUN5114DW1T1G		7.0	10	13	
	LMUN5115DW1T1G		7.0	10	13	
	LMUN5116DW1T1G		3.3	4.7	6.1	
	LMUN5130DW1T1G		0.7	1.0	1.3	
	LMUN5131DW1T1G		1.5	2.2	2.9	
	LMUN5132DW1T1G		3.3	4.7	6.1	
	LMUN5133DW1T1G		3.3	4.7	6.1	
	LMUN5134DW1T1G		15.4	22	28.6	
	LMUN5135DW1T1G		1.54	2.2	2.86	
	LMUN5136DW1T1G		70	100	130	
	LMUN5137DW1T1G		32.9	47	61.1	
Resistor Ratio	LMUN5111DW1T1G	R <sub>1</sub> /R <sub>2</sub>	0.8	1.0	1.2	
	LMUN5112DW1T1G		0.8	1.0	1.2	
	LMUN5113DW1T1G		0.8	1.0	1.2	
	LMUN5114DW1T1G		0.17	0.21	0.25	
	LMUN5115DW1T1G		-	-	-	
	LMUN5116DW1T1G		-	-	-	
	LMUN5130DW1T1G		0.8	1.0	1.2	
	LMUN5131DW1T1G		0.8	1.0	1.2	
	LMUN5132DW1T1G		0.8	1.0	1.2	
	LMUN5133DW1T1G		0.055	0.12	0.185	
	LMUN5134DW1T1G		0.38	0.47	0.56	
	LMUN5135DW1T1G		0.038	0.047	0.056	
	LMUN5136DW1T1G		0.8	1.0	1.2	
	LMUN5137DW1T1G		1.7	2.15	2.6	

5. Pulse Test: Pulse Width < 300 ms, Duty Cycle < 2.0%

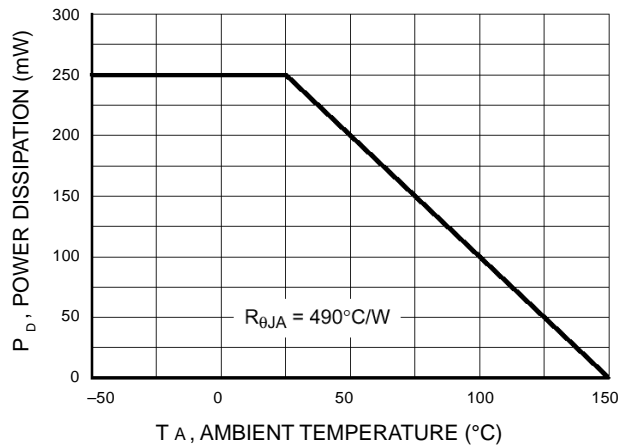

**Figure 1. Derating Curve**

TYPICAL ELECTRICAL CHARACTERISTICS – LMUN5111DW1T1G

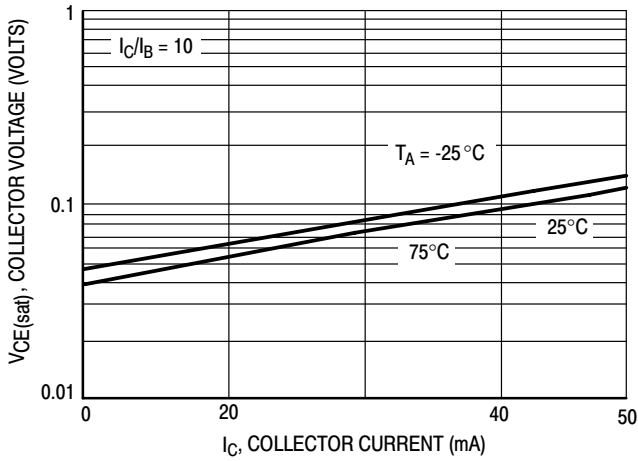

Figure 2.  $V_{CE(sat)}$  versus  $I_C$

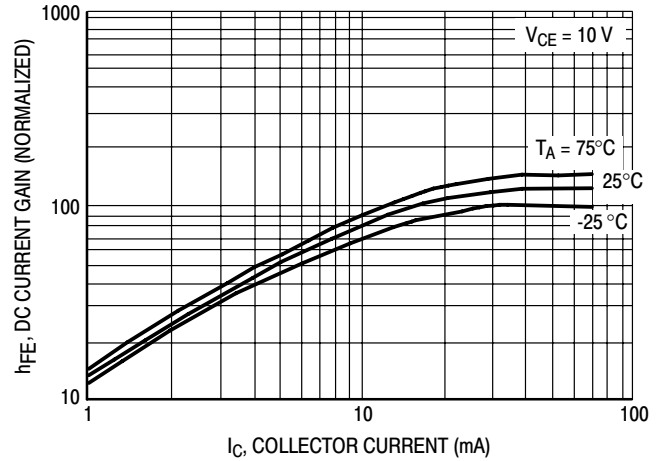

Figure 3. DC Current Gain

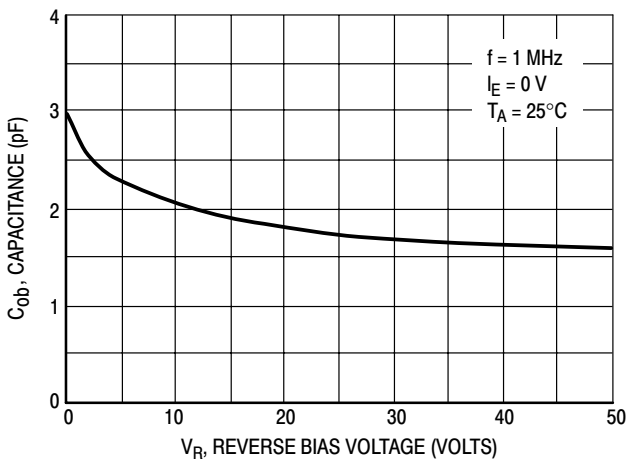

Figure 4. Output Capacitance

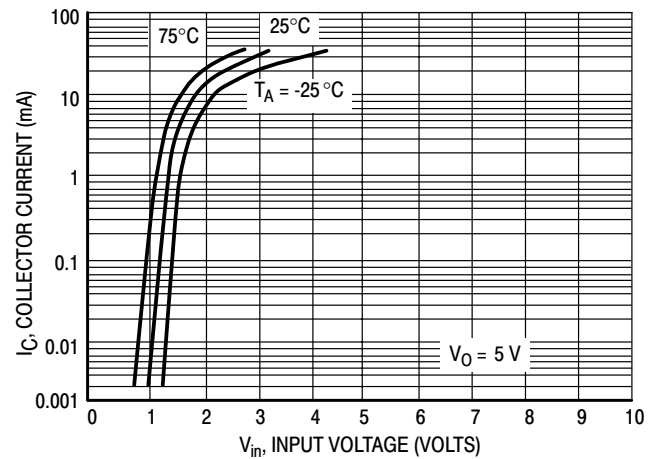

Figure 5. Output Current versus Input Voltage

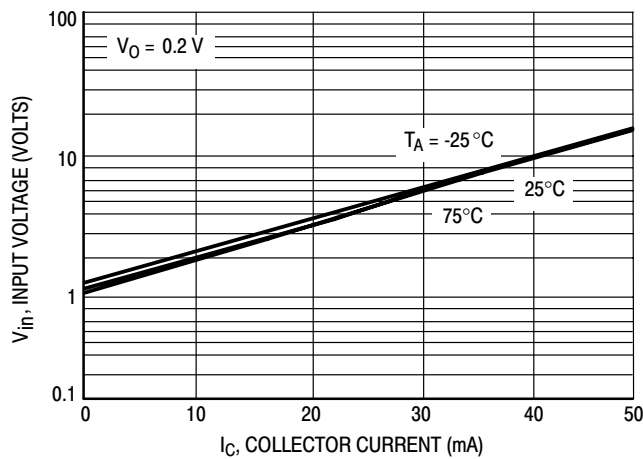

Figure 6. Input Voltage versus Output Current

TYPICAL ELECTRICAL CHARACTERISTICS – LMUN5112DW1T1G

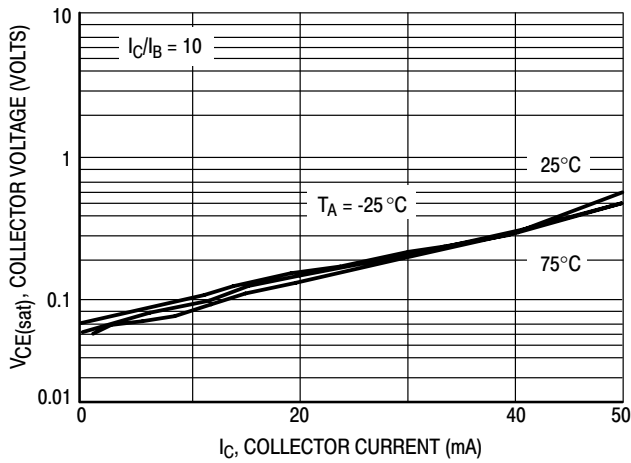

Figure 7.  $V_{CE(sat)}$  versus  $I_C$

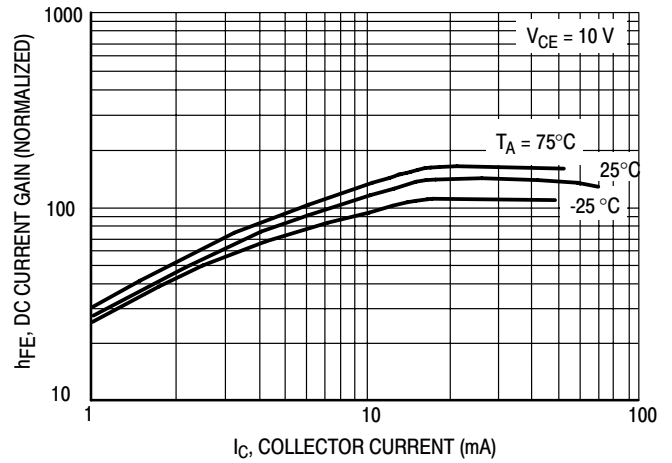

Figure 8. DC Current Gain

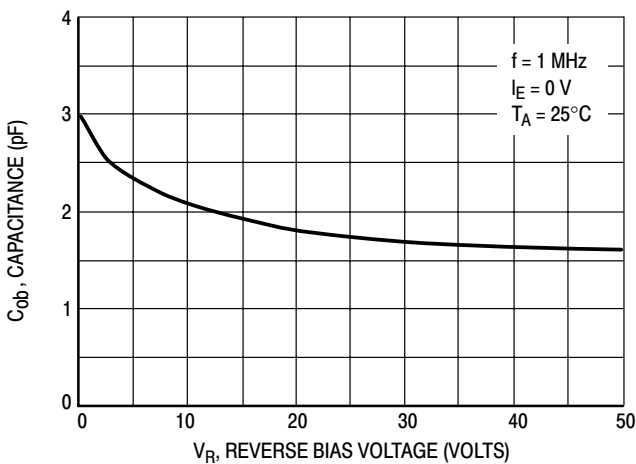

Figure 9. Output Capacitance

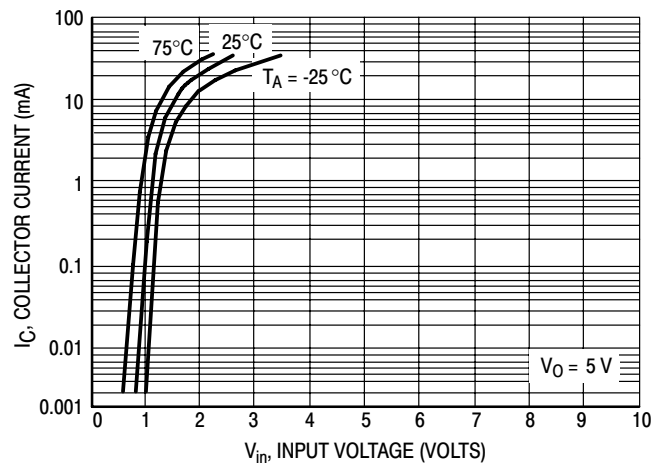

Figure 10. Output Current versus Input Voltage

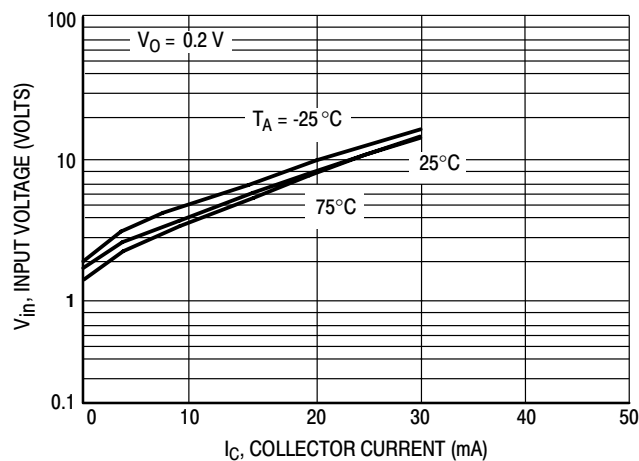

Figure 11. Input Voltage versus Output Current

TYPICAL ELECTRICAL CHARACTERISTICS – LMUN5113DW1T1G

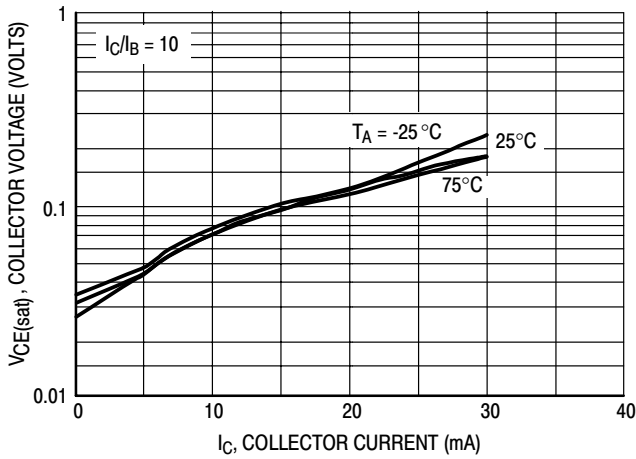

Figure 12.  $V_{CE(sat)}$  versus  $I_C$

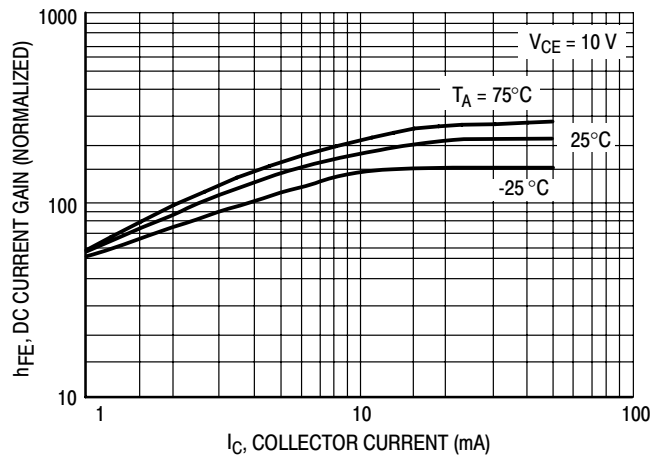

Figure 13. DC Current Gain

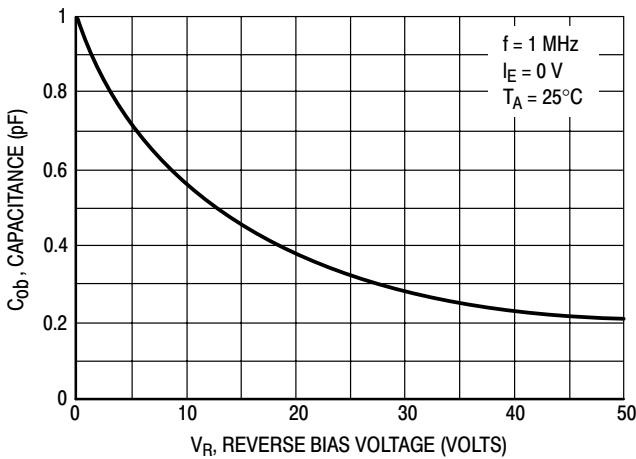

Figure 14. Output Capacitance

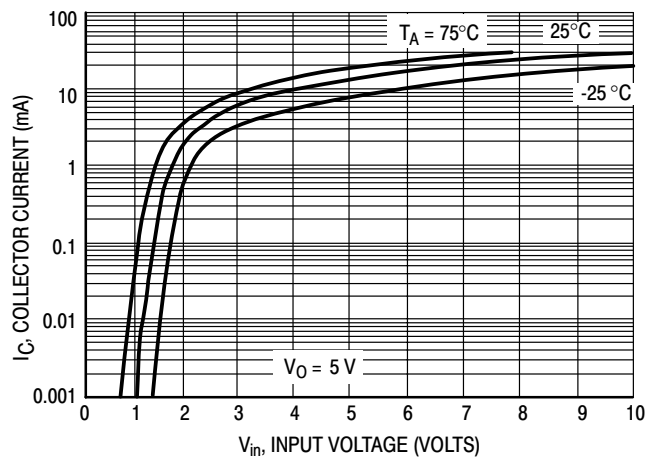

Figure 15. Output Current versus Input Voltage

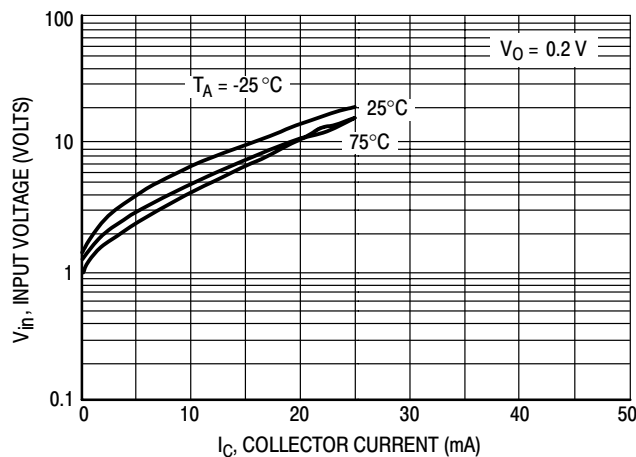

Figure 16. Input Voltage versus Output Current

TYPICAL ELECTRICAL CHARACTERISTICS – LMUN5114DW1T1G

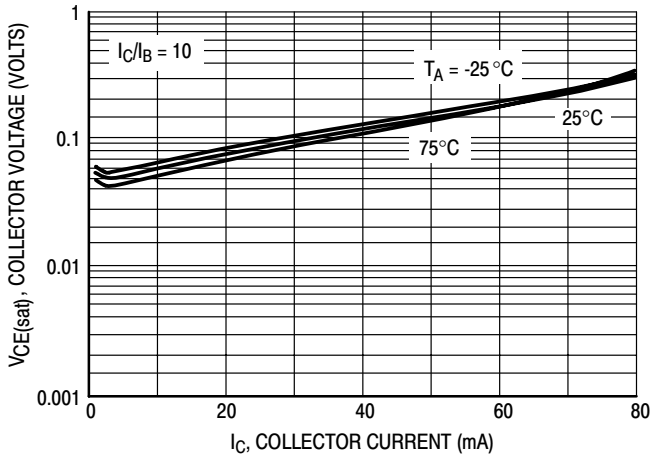

Figure 17.  $V_{CE(sat)}$  versus  $I_C$

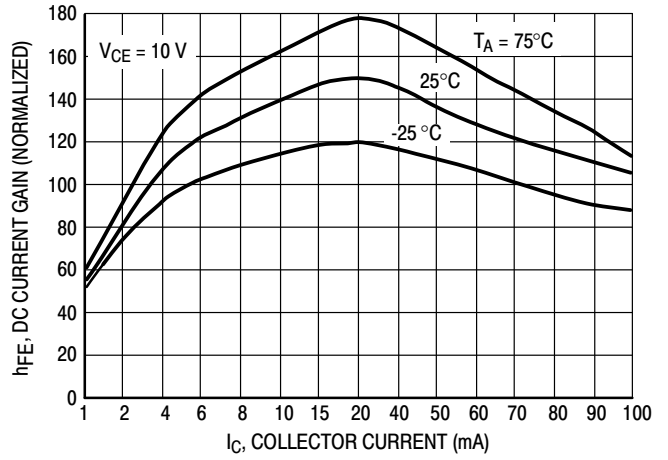

Figure 18. DC Current Gain

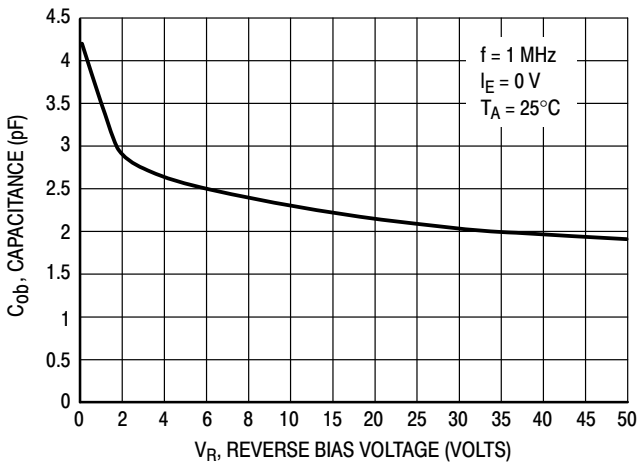

Figure 19. Output Capacitance

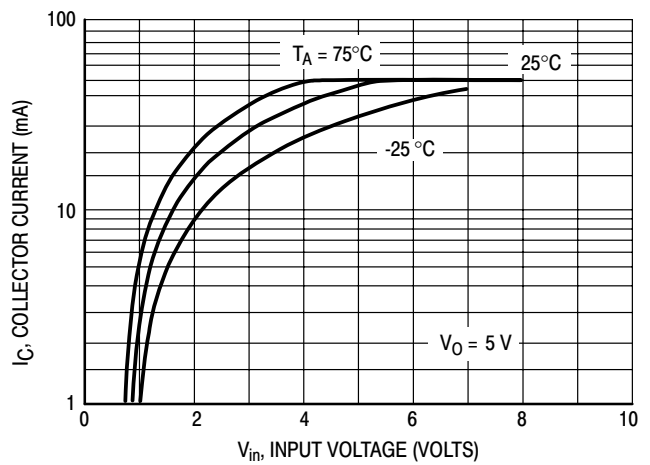

Figure 20. Output Current versus Input Voltage

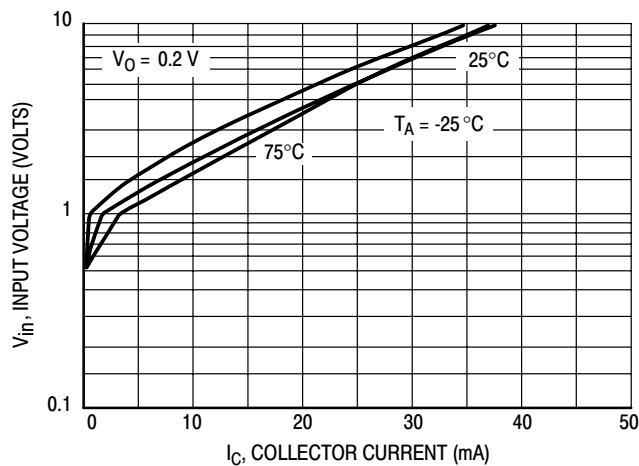

Figure 21. Input Voltage versus Output Current



TYPICAL ELECTRICAL CHARACTERISTICS – LMUN5115DW1T1G

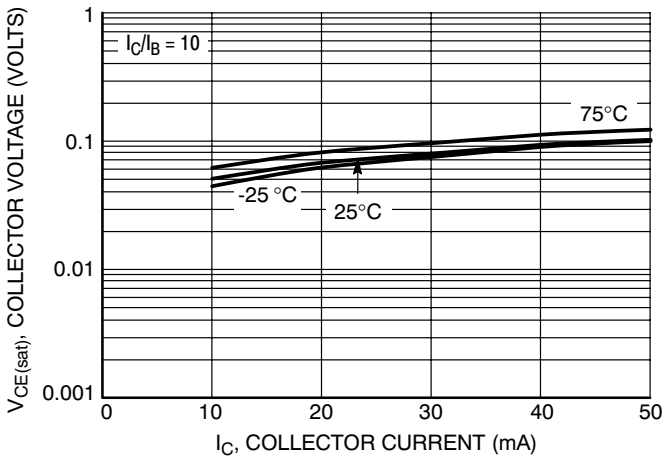

Figure 22.  $V_{CE(sat)}$  versus  $I_C$

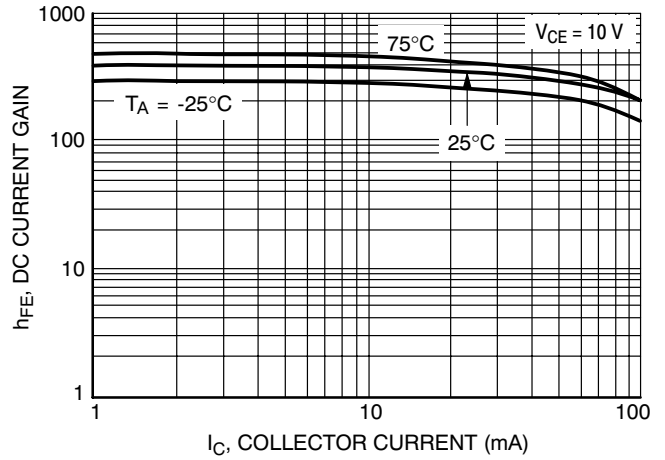

Figure 23. DC Current Gain

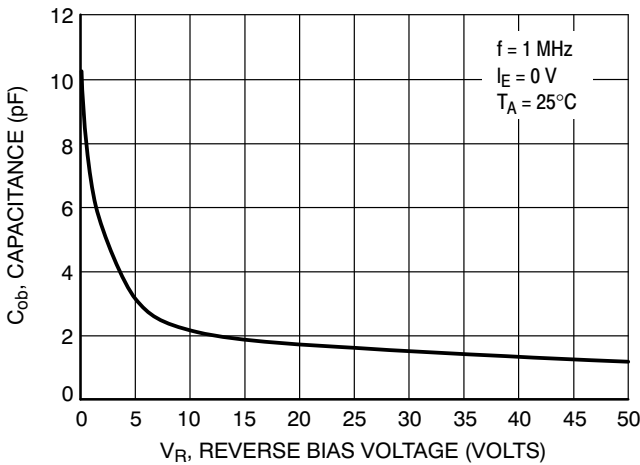

Figure 24. Output Capacitance

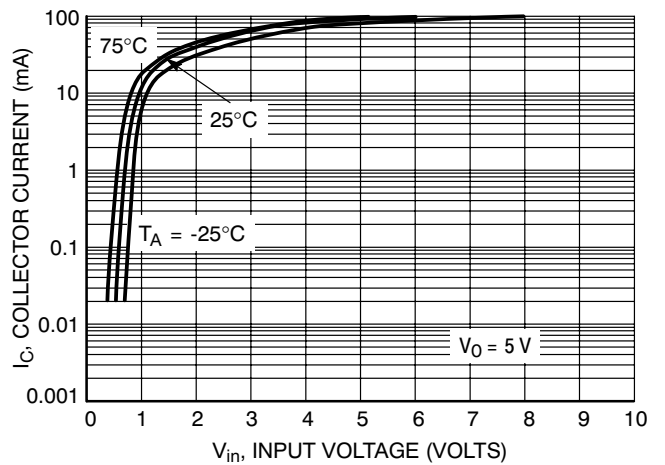

Figure 25. Output Current versus Input Voltage

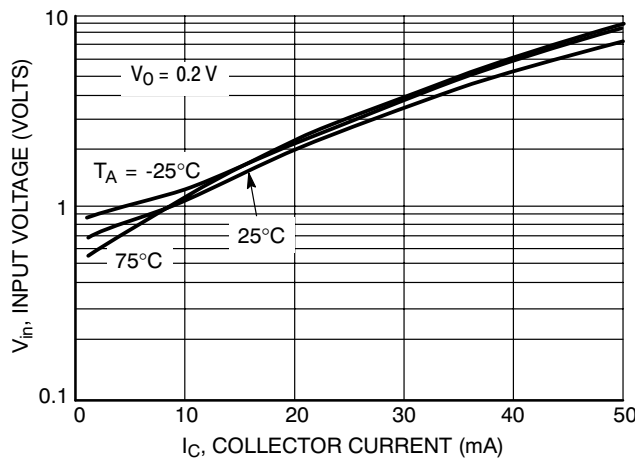

Figure 26. Input Voltage versus Output Current

TYPICAL ELECTRICAL CHARACTERISTICS – LMUN5116DW1T1G

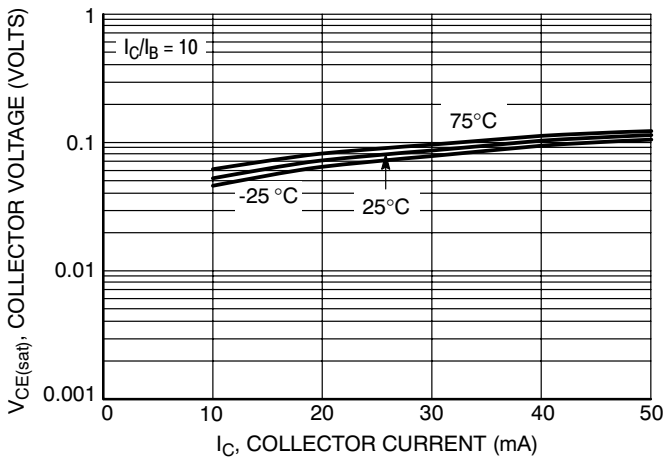

Figure 27.  $V_{CE(sat)}$  versus  $I_C$

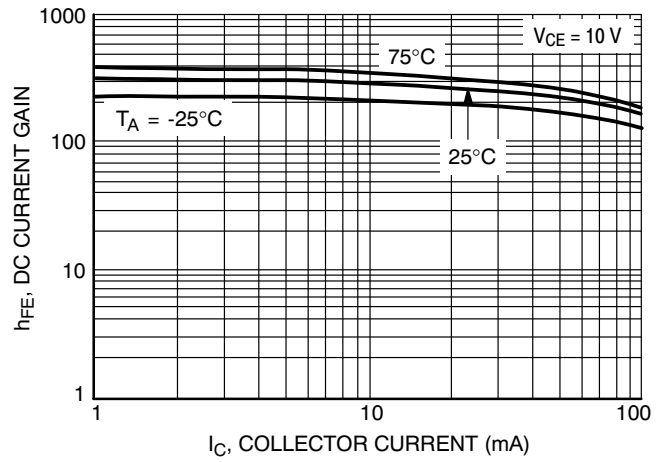

Figure 28. DC Current Gain

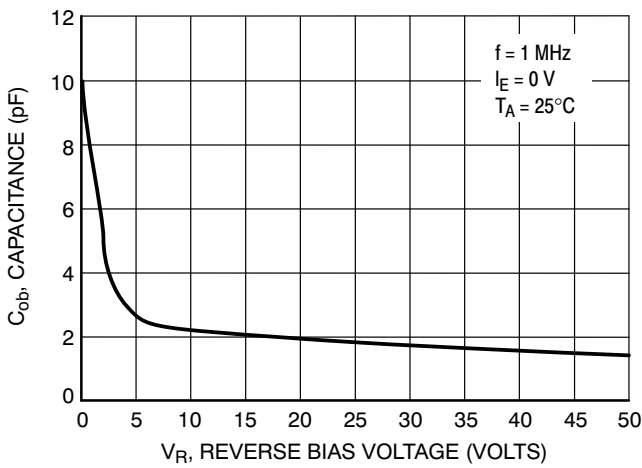

Figure 29. Output Capacitance

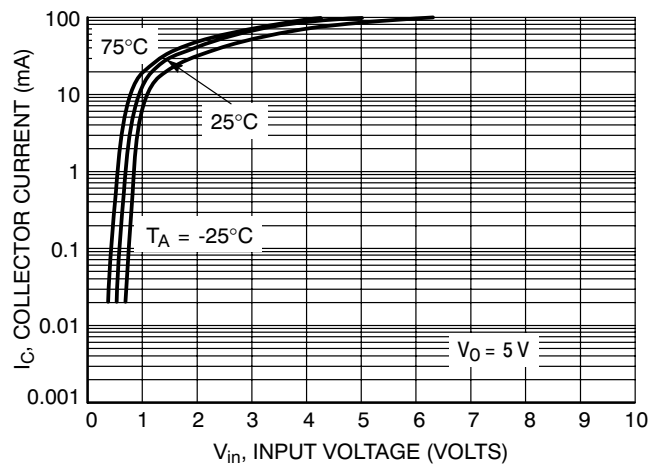

Figure 30. Output Current versus Input Voltage

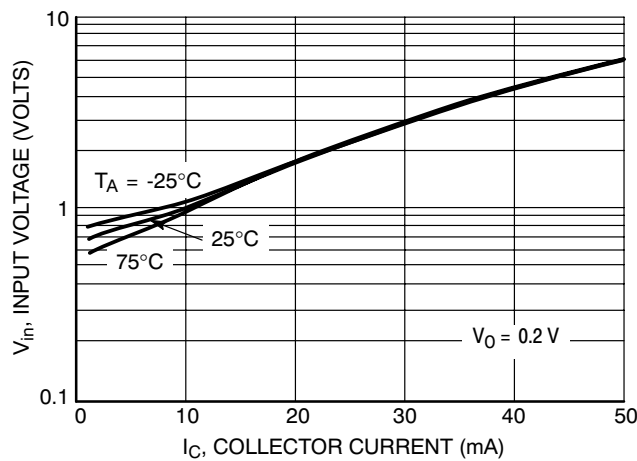

Figure 31. Input Voltage versus Output Current

TYPICAL ELECTRICAL CHARACTERISTICS – LMUN5130DW1T1G

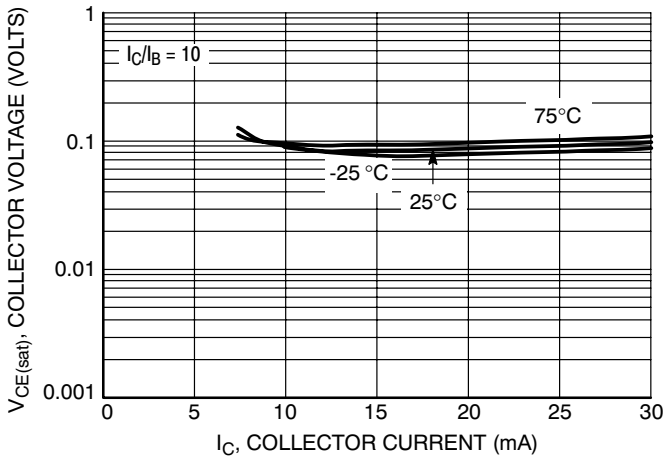

Figure 32.  $V_{CE(sat)}$  versus  $I_C$

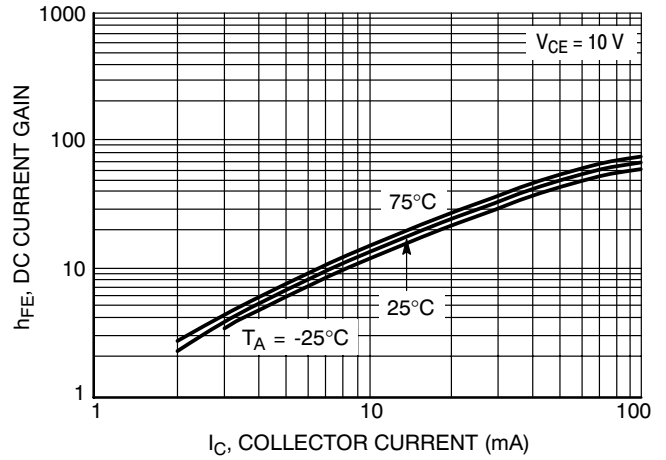

Figure 33. DC Current Gain

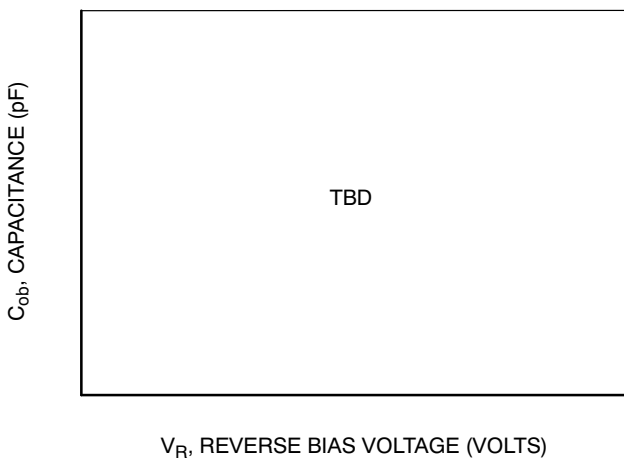

Figure 34. Output Capacitance

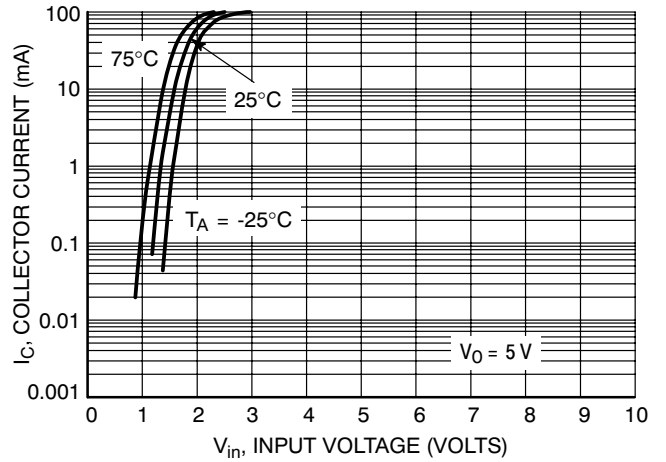

Figure 35. Output Current versus Input Voltage

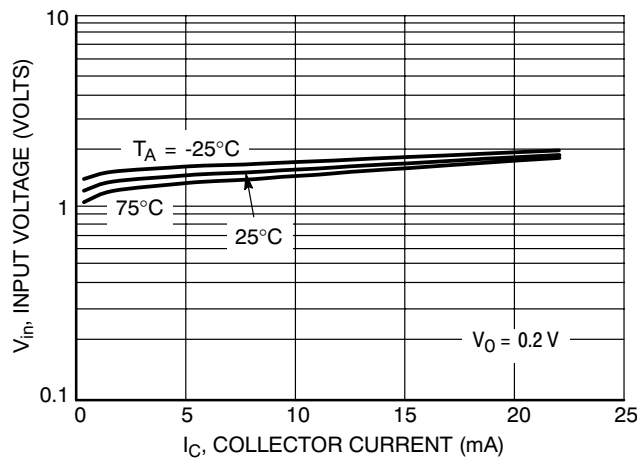

Figure 36. Input Voltage versus Output Current

TYPICAL ELECTRICAL CHARACTERISTICS – LMUN5131DW1T1G

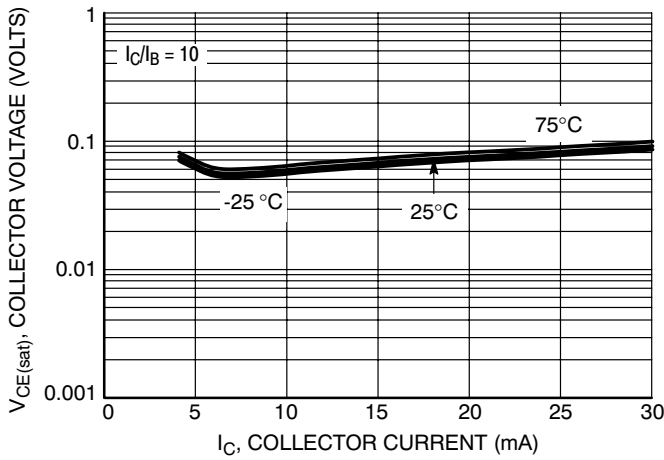

Figure 37.  $V_{CE(sat)}$  versus  $I_C$

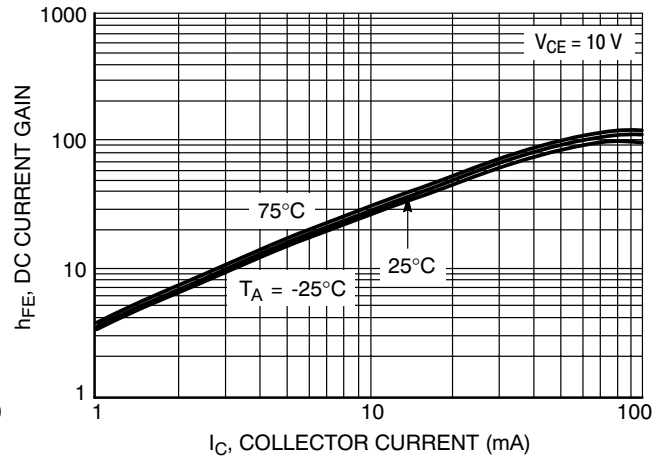

Figure 38. DC Current Gain

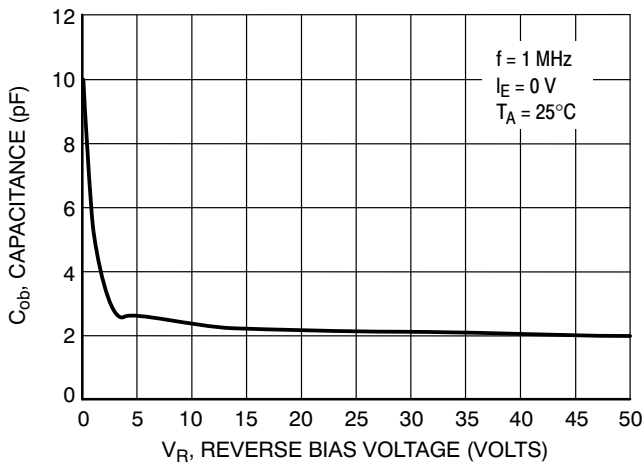

Figure 39. Output Capacitance

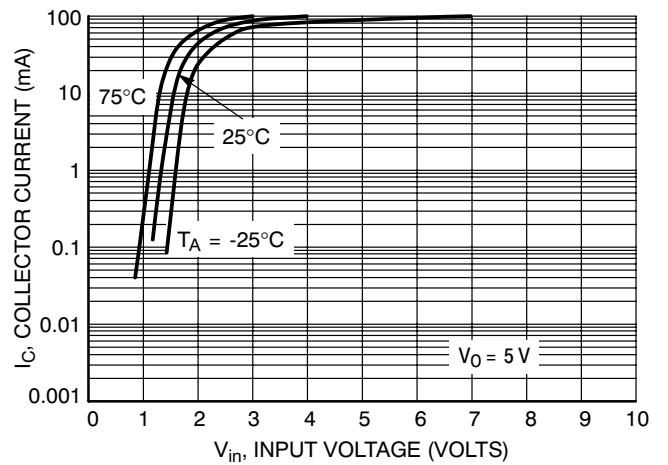

Figure 40. Output Current versus Input Voltage

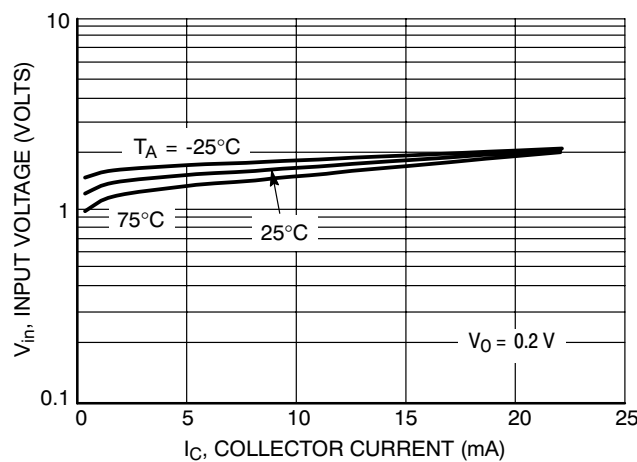

Figure 41. Input Voltage versus Output Current

TYPICAL ELECTRICAL CHARACTERISTICS – LMUN5132DW1T1G

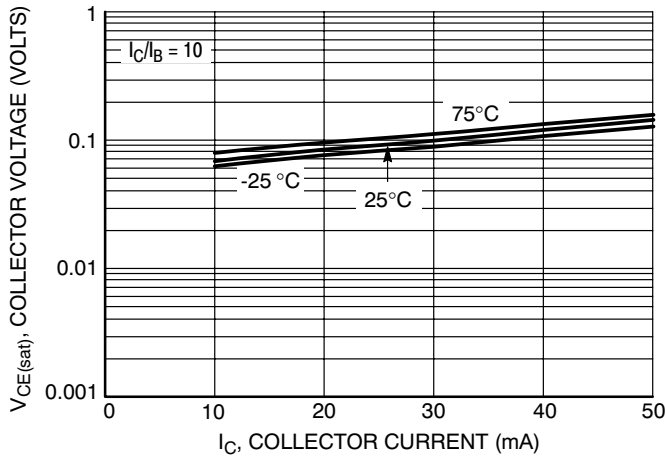

Figure 42.  $V_{CE(sat)}$  versus  $I_C$

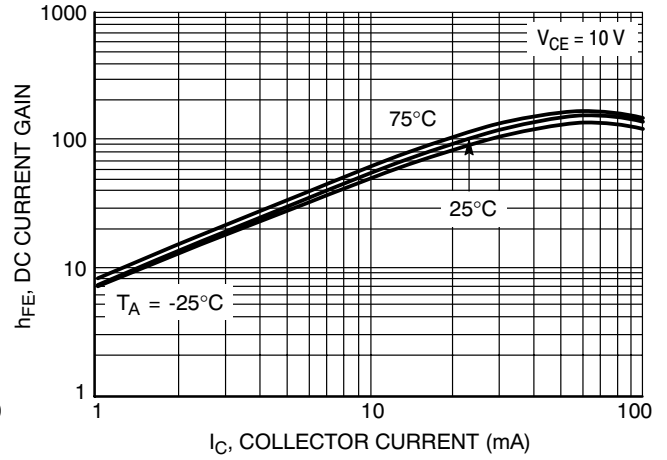

Figure 43. DC Current Gain

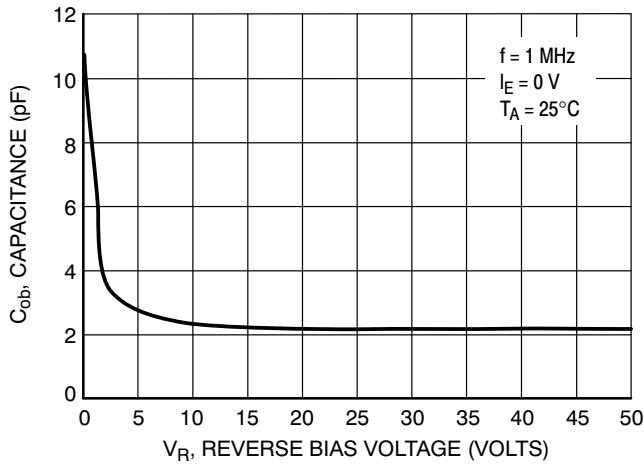

Figure 44. Output Capacitance

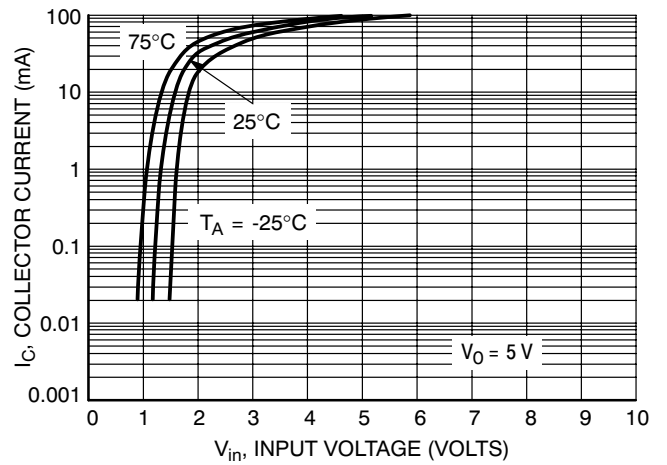

Figure 45. Output Current versus Input Voltage

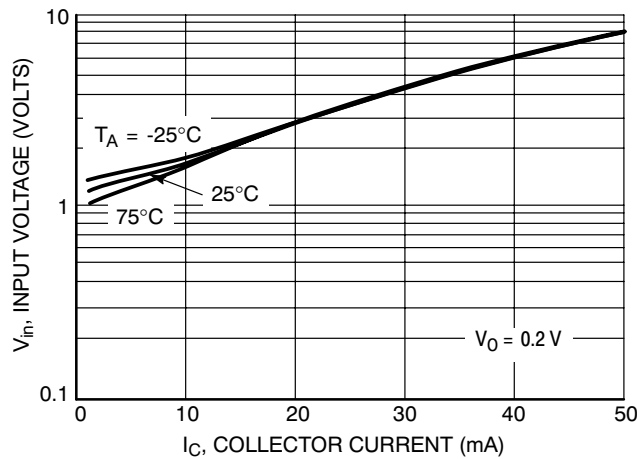

Figure 46. Input Voltage versus Output Current

TYPICAL ELECTRICAL CHARACTERISTICS – LMUN5133DW1T1G

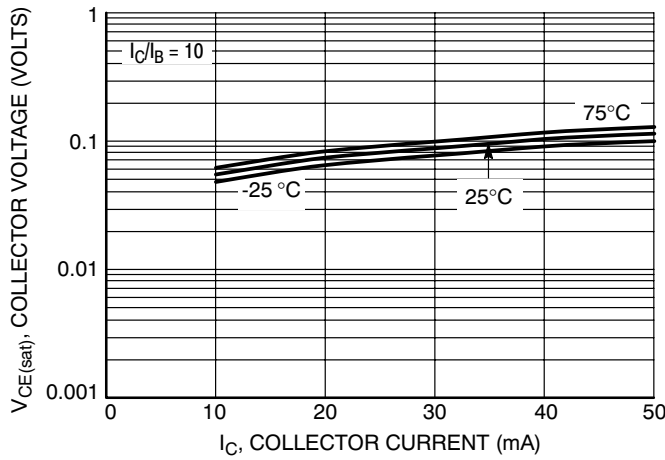

Figure 47.  $V_{CE(sat)}$  versus  $I_C$

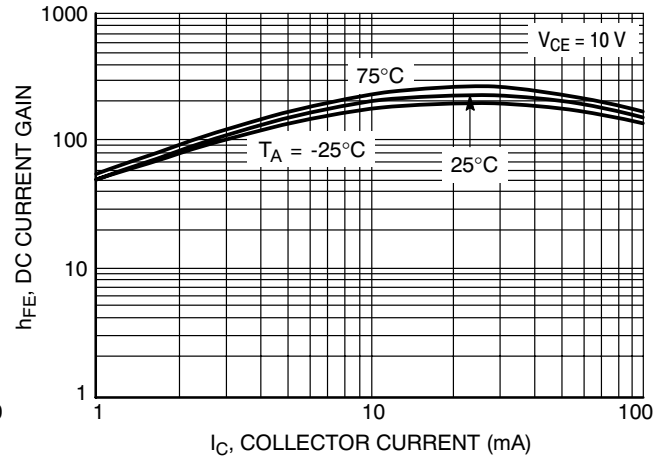

Figure 48. DC Current Gain

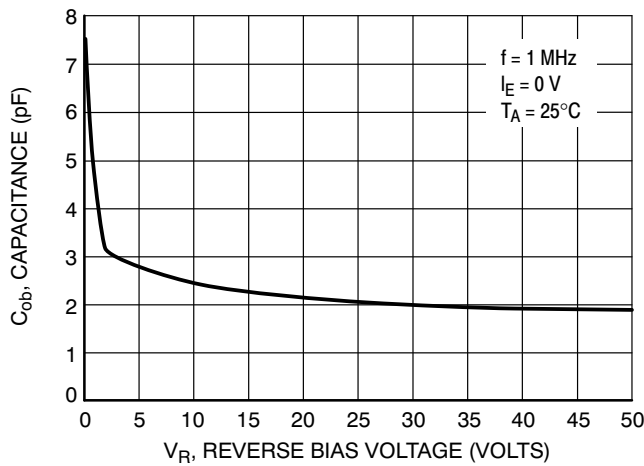

Figure 49. Output Capacitance

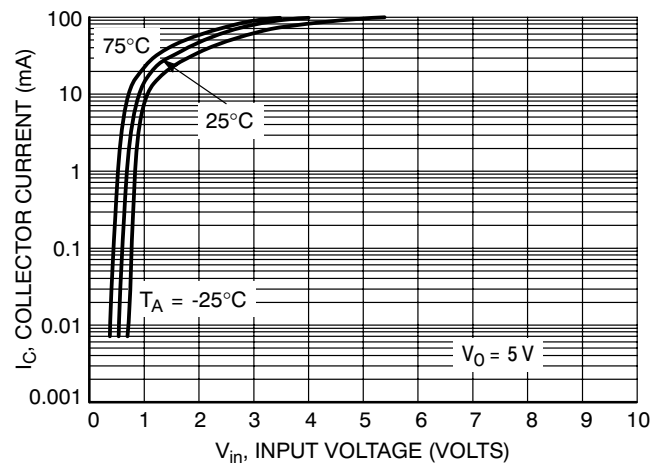

Figure 50. Output Current versus Input Voltage

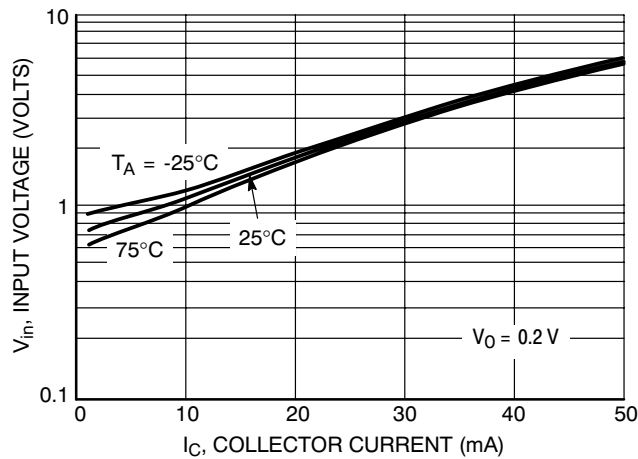

Figure 51. Input Voltage versus Output Current

TYPICAL ELECTRICAL CHARACTERISTICS – LMUN5134DW1T1G

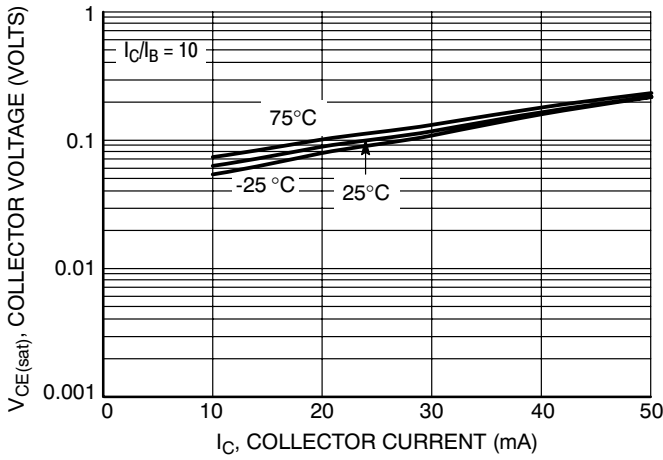

Figure 52.  $V_{CE(sat)}$  versus  $I_C$

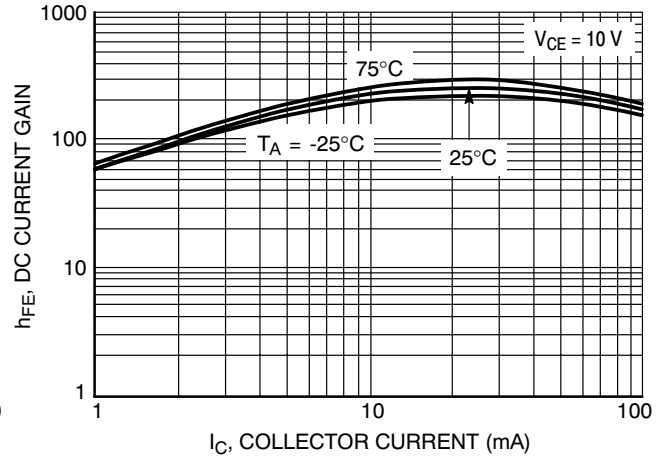

Figure 53. DC Current Gain

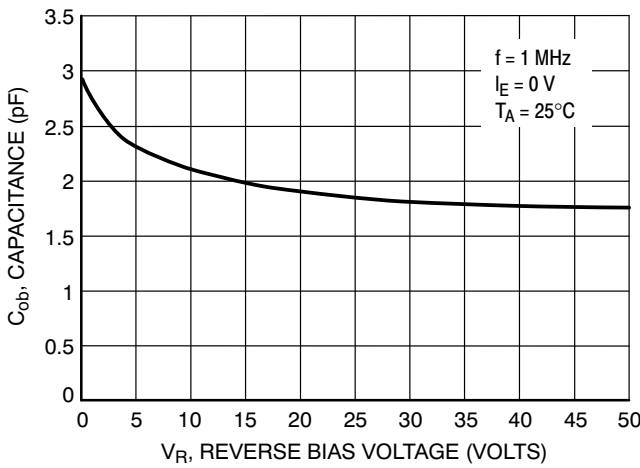

Figure 54. Output Capacitance

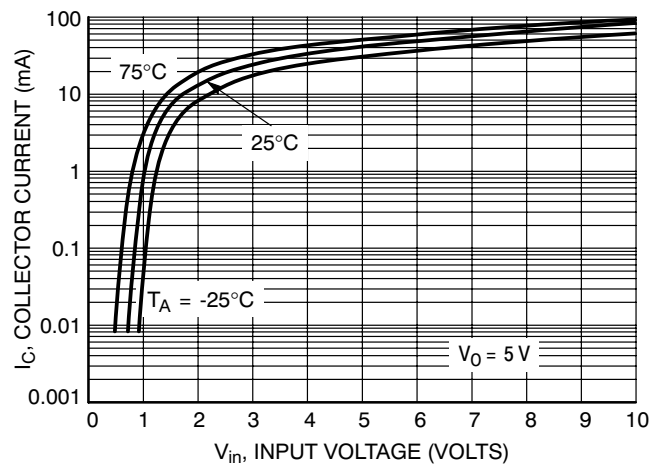

Figure 55. Output Current versus Input Voltage

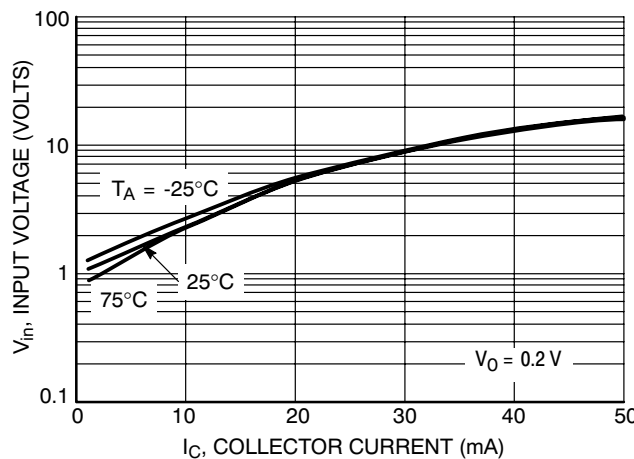

Figure 56. Input Voltage versus Output Current

TYPICAL ELECTRICAL CHARACTERISTICS – LMUN5135DW1T1G

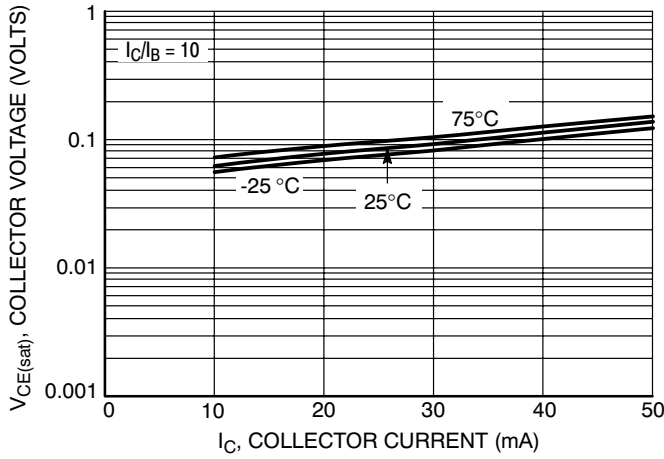

Figure 57.  $V_{CE(sat)}$  versus  $I_C$

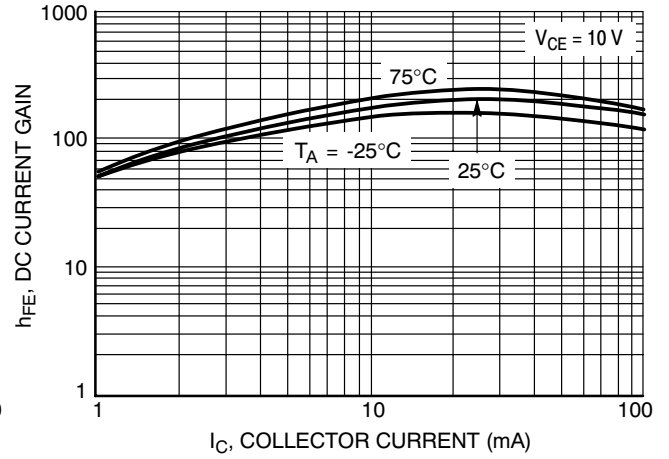

Figure 58. DC Current Gain

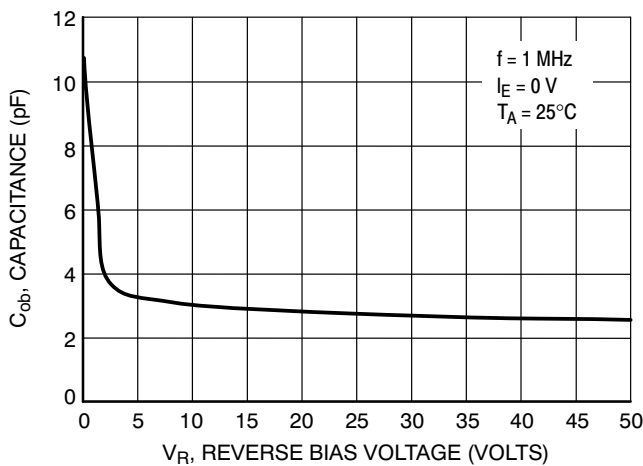

Figure 59. Output Capacitance

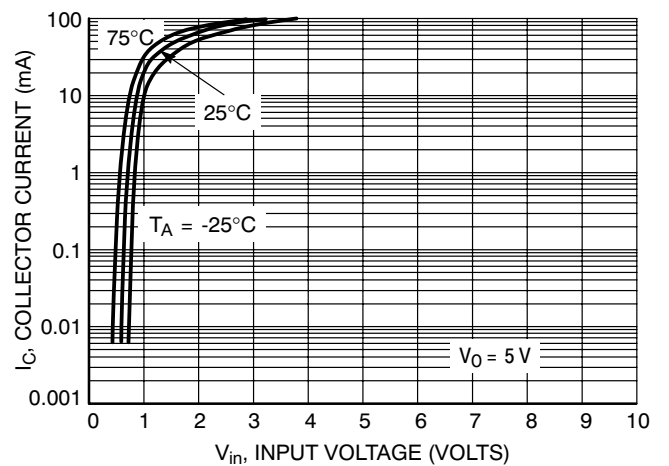

Figure 60. Output Current versus Input Voltage

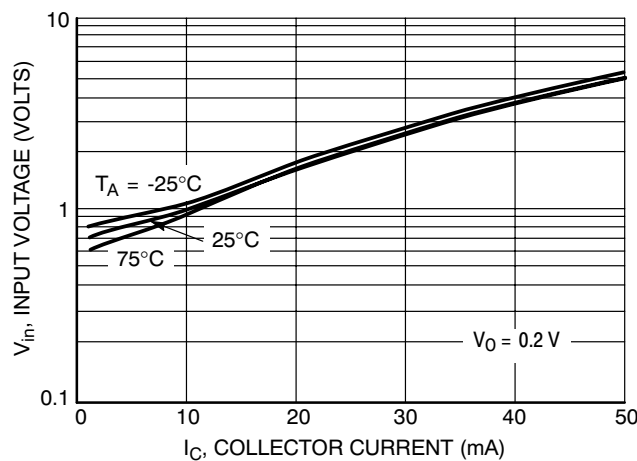

Figure 61. Input Voltage versus Output Current



TYPICAL ELECTRICAL CHARACTERISTICS – LMUN5136DW1T1G

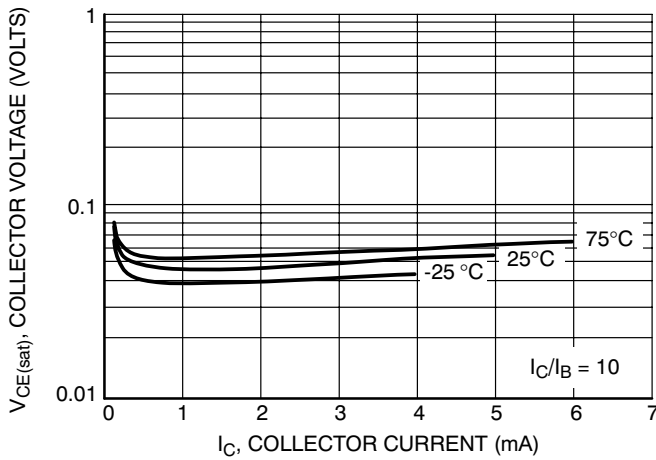

Figure 62.  $V_{CE(sat)}$  versus  $I_C$

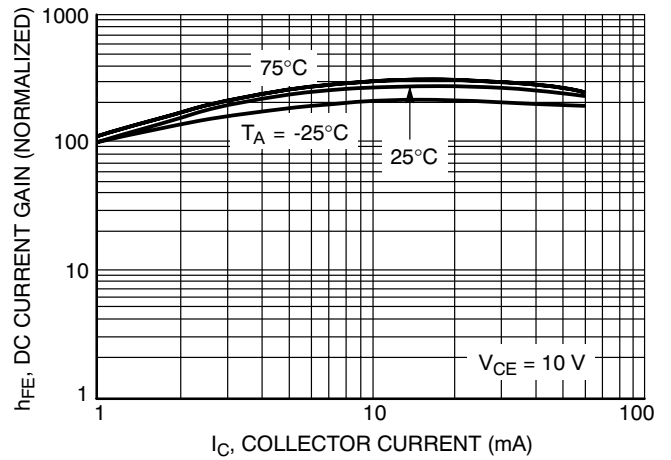

Figure 63. DC Current Gain

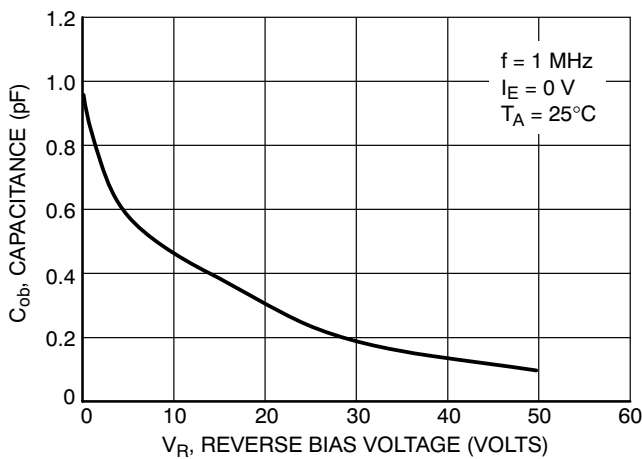

Figure 64. Output Capacitance

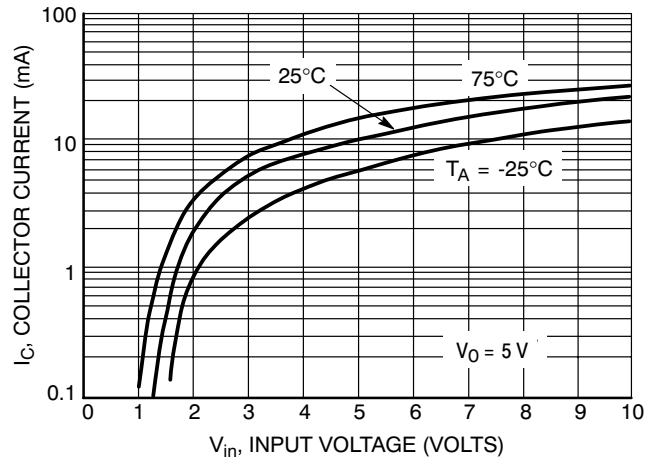

Figure 65. Output Current versus Input Voltage

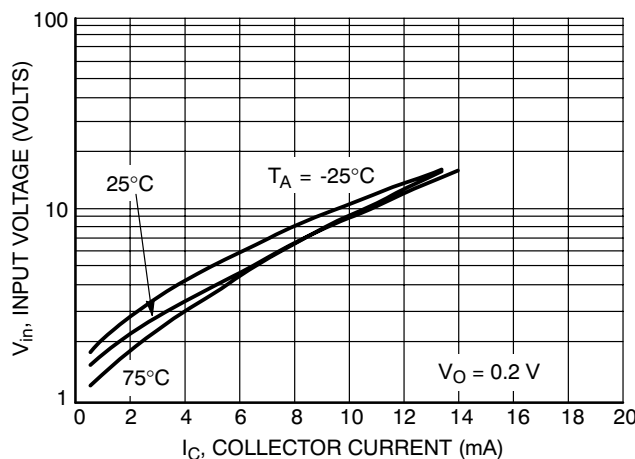

Figure 66. Input Voltage versus Output Current

TYPICAL ELECTRICAL CHARACTERISTICS – LMUN5137DW1T1G

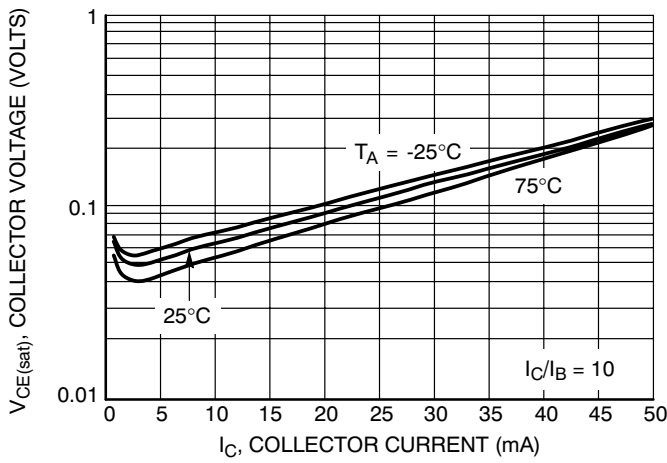

Figure 67.  $V_{CE(sat)}$  versus  $I_C$

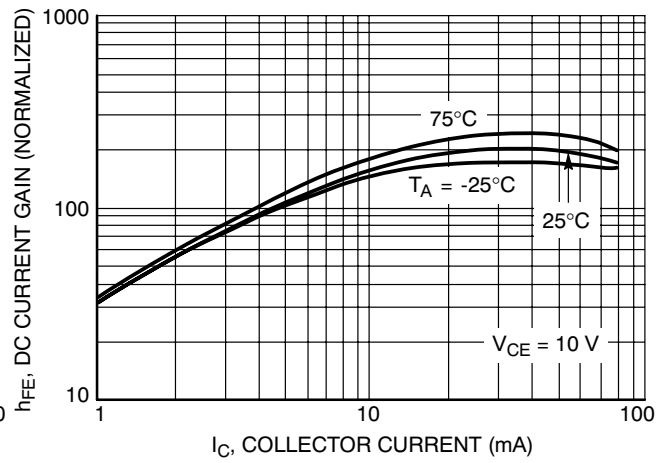

Figure 68. DC Current Gain

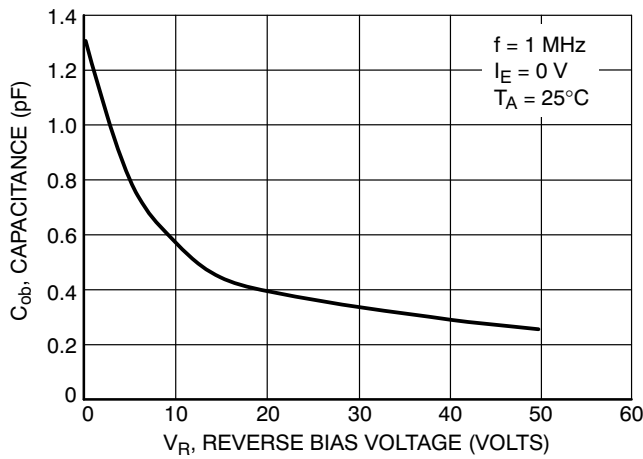

Figure 69. Output Capacitance

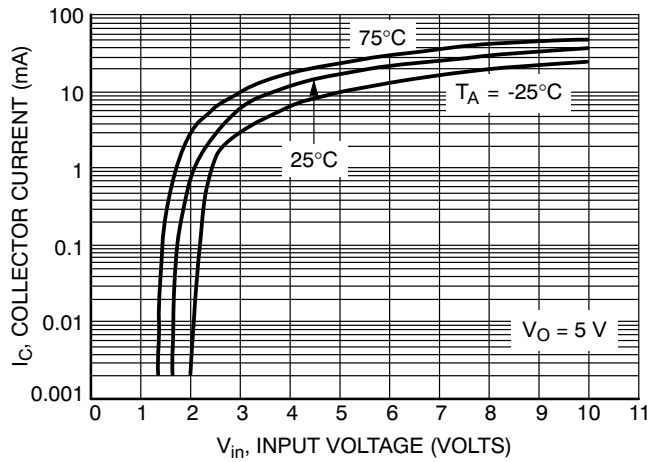

Figure 70. Output Current versus Input Voltage

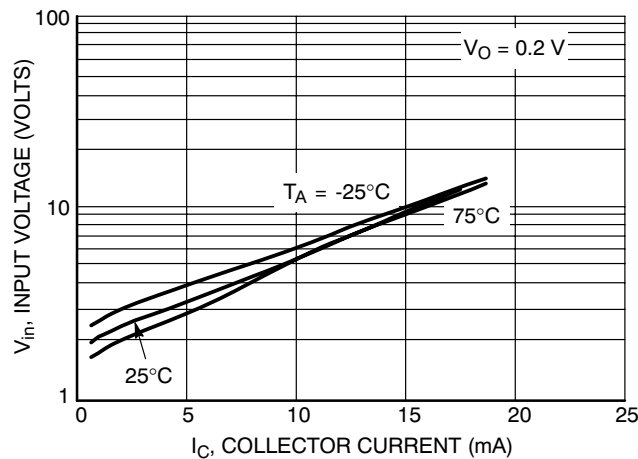
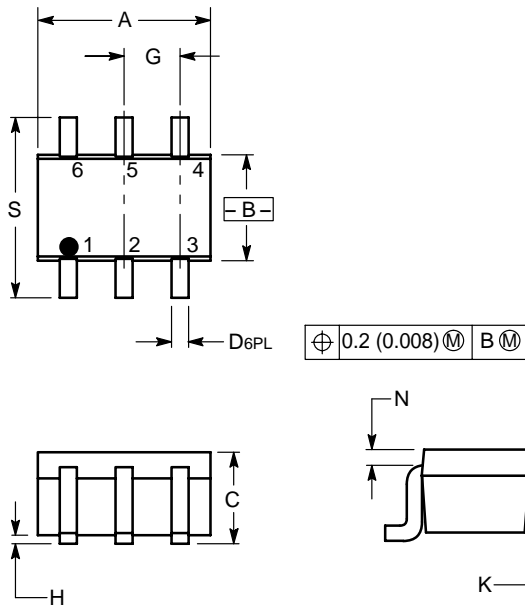

Figure 71. Input Voltage versus Output Current

SC-88/SOT-363



NOTES:

1. DIMENSIONING AND TOLERANCING PER ANSI Y14.5M, 1982.
2. CONTROLLING DIMENSION: INCH.

DIM	INCHES		MILLIMETERS	
	MIN	MAX	MIN	MAX
A	0.071	0.087	1.80	2.20
B	0.045	0.053	1.15	1.35
C	0.031	0.043	0.80	1.10
D	0.004	0.012	0.10	0.30
G	0.026 BSC		0.65 BSC	
H	---	0.004	---	0.10
J	0.004	0.010	0.10	0.25
K	0.004	0.012	0.10	0.30
N	0.008 REF		0.20 REF	
S	0.079	0.087	2.00	2.20

- PIN 1. EMITTER 2  
2. BASE 2  
3. COLLECTOR 1  
4. EMITTER 1  
5. BASE 1  
6. COLLECTOR 2

