

# LDTD143ELT1G

## S-LDTD143ELT1G

Bias Resistor Transistors  
NPN Silicon Surface Mount Transistors  
with Monolithic Bias Resistor Network

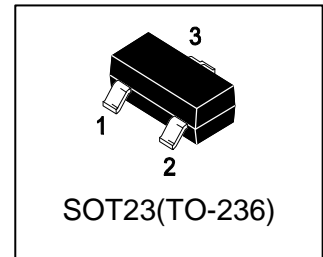

### 1. FEATURES

- Built-in bias resistors enable the configuration of an inverter circuit without connecting external input resistors.
- The bias resistors consist of thin-film resistors with complete isolation to allow positive biasing of the input. They also have the advantage of almost completely eliminating parasitic effects.
- Only the on/off conditions need to be set for operation, making the device design easy.
- We declare that the material of product complies with RoHS requirements and Halogen Free.
- S- prefix for automotive and other applications requiring unique site and control change requirements; AEC-Q101 qualified and PPAP capable.

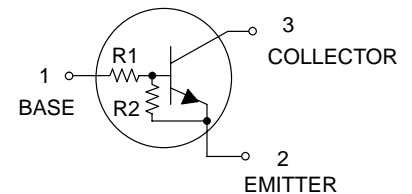

### 2. Applications

- Inverter, Interface, Driver.

### 3. DEVICE MARKING AND ORDERING INFORMATION

Device	Marking	R1(K)	R2(K)	Vin(V)	Shipping
LDTD143ELT1G	E6	4.7	4.7	-10~+30	3000/Tape&Reel
LDTD143ELT3G	E6	4.7	4.7	-10~+30	10000/Tape&Reel

### 4. MAXIMUM RATINGS(Ta = 25°C)

Parameter	Symbol	Limits	Unit
Collector–Emitter Voltage	V <sub>CEO</sub>	50	V
Collector–Base Voltage	V <sub>CBO</sub>	50	V
Collector Current	I <sub>C</sub>	500	mA

### 5. THERMAL CHARACTERISTICS

Parameter	Symbol	Limits	Unit
Total Device Dissipation, FR-5 Board (Note 1) @ TA = 25°C Derate above 25°C	PD	225 1.8	mW mW/°C
Thermal Resistance, Junction–to–Ambient(Note 1)	R <sub>ΘJA</sub>	556	°C/W
Junction and Storage temperature	T <sub>J</sub> , T <sub>stg</sub>	-55~+150	°C

1. FR-5 = 1.0×0.75×0.062 in.

## 6. ELECTRICAL CHARACTERISTICS (Ta= 25°C)

### OFF CHARACTERISTICS

Characteristic	Symbol	Min.	Typ.	Max.	Unit
Collector–Emitter Breakdown Voltage (IC = 2.0 mA, IB = 0)	VBR(CEO)	50	-	-	V
Collector–Base Breakdown Voltage (IC = 10 μA, IE = 0)	VBR(CBO)	50	-	-	V
Collector-Base Cutoff Current (VCB = 50 V, IE = 0)	ICBO	-	-	100	nA
Collector-Emitter Cutoff Current (VCE = 50 V, IB = 0)	ICEO	-	-	1	μA
Emitter-Base Cutoff Current (VEB = 5.0 V, IC = 0)	IEBO	-	-	1.8	mA

### ON CHARACTERISTICS (Note 2.)

DC Current Gain (IC = 50 mA, VCE = 5 V)	HFE	47	-	-	
Collector–Emitter Saturation Voltage (IC = 50 mA, IB = 2.5 mA)	VCE(sat)	-	-	0.3	V
Input Voltage (off) (VCE = 5.0 V, IC = 100 μA)	Vi(off)	-	-	0.5	V
Input Voltage (on) (VCE = 0.3 V, IC = 20 mA)	Vi(on)	3	-	-	V
Output Voltage (on) (VCC = 5.0 V, VB = 3 V, RL =1.0KΩ)	VOL	-	-	0.3	V
Output Voltage (on) (VCC = 5.0 V, VB = 0.5 V, RL =1.0KΩ)	VOH	4.9	-	-	V
Input Resistor	R1	3.29	4.7	6.11	KΩ
Resistor Ratio	R1/R2	0.8	1	1.2	

2. Pulse Test: Pulse Width < 300 μs, Duty Cycle < 2.0%

### 7.ELECTRICAL CHARACTERISTICS CURVES

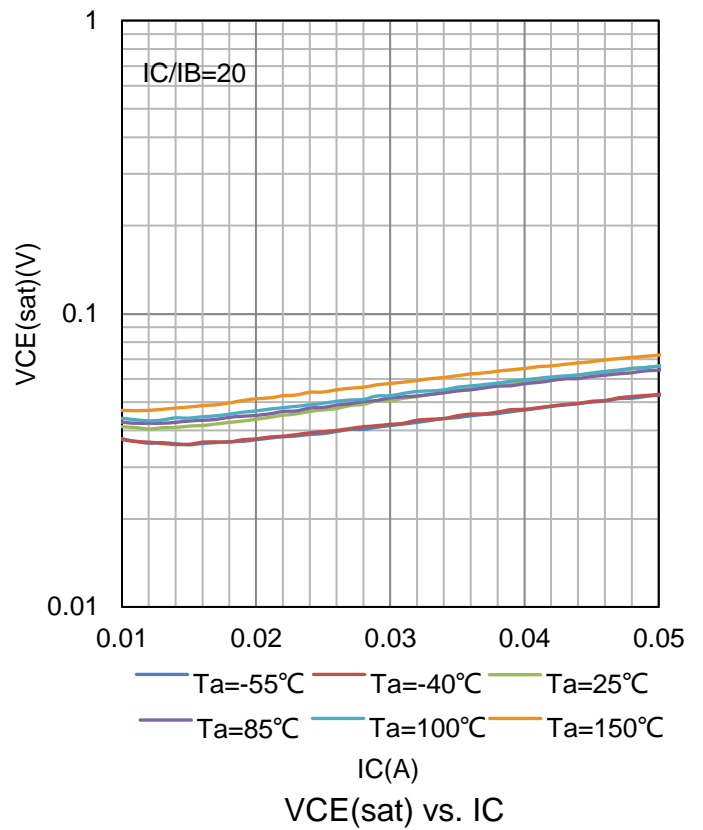
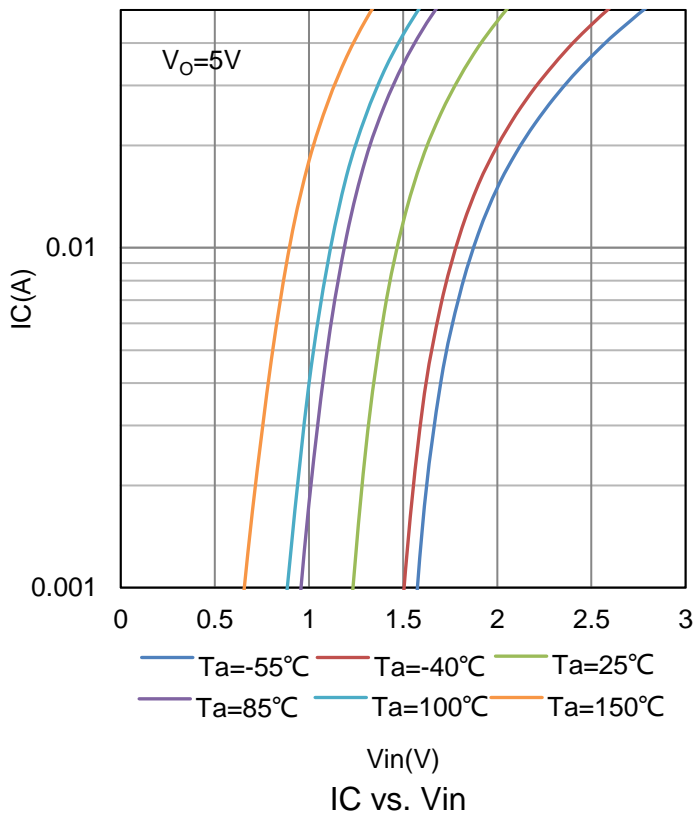
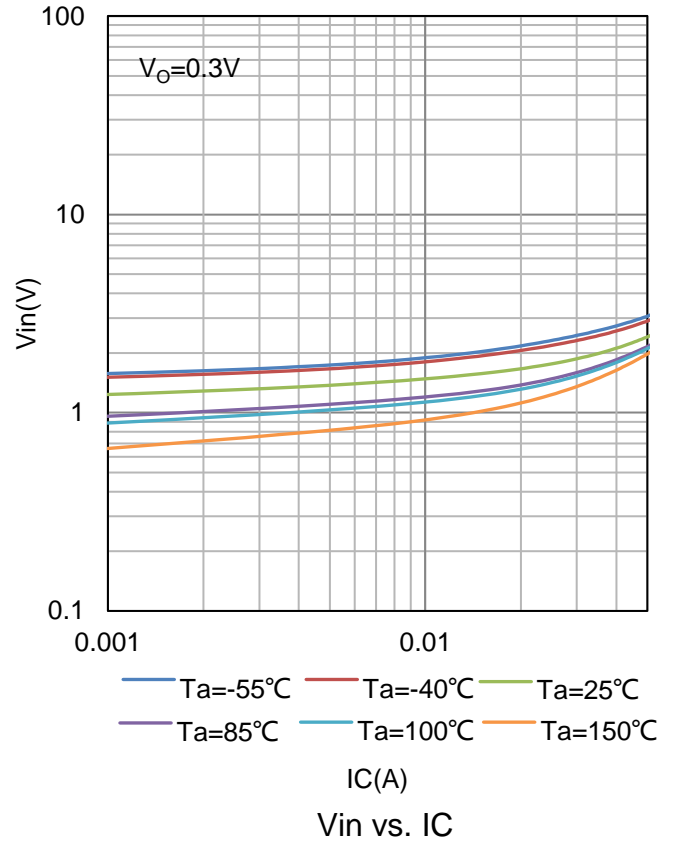
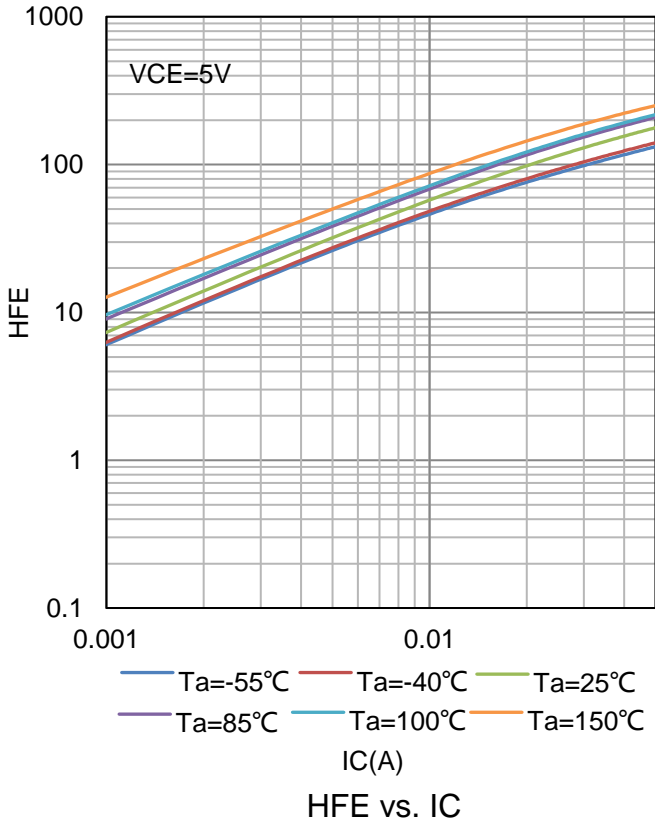

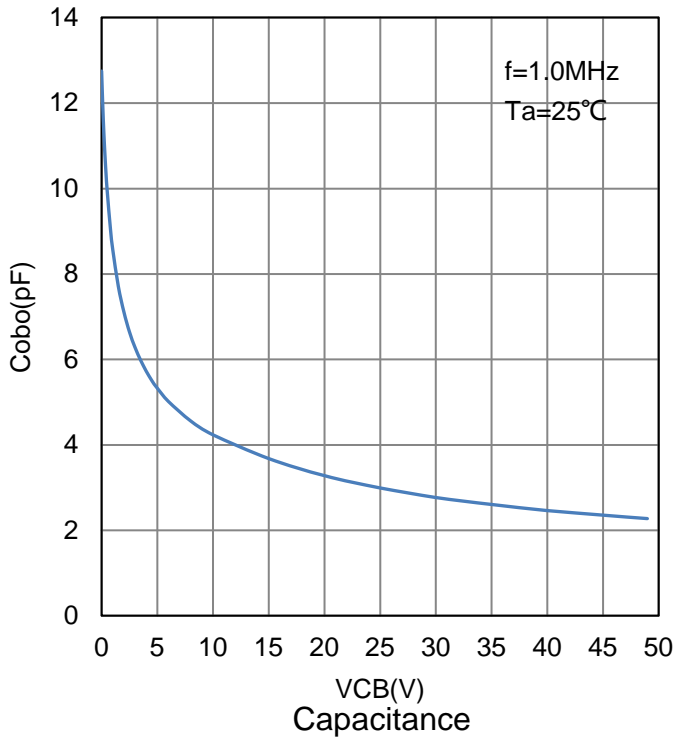
**7.ELECTRICAL CHARACTERISTICS CURVES(Con.)**

### 8.OUTLINE AND DIMENSIONS

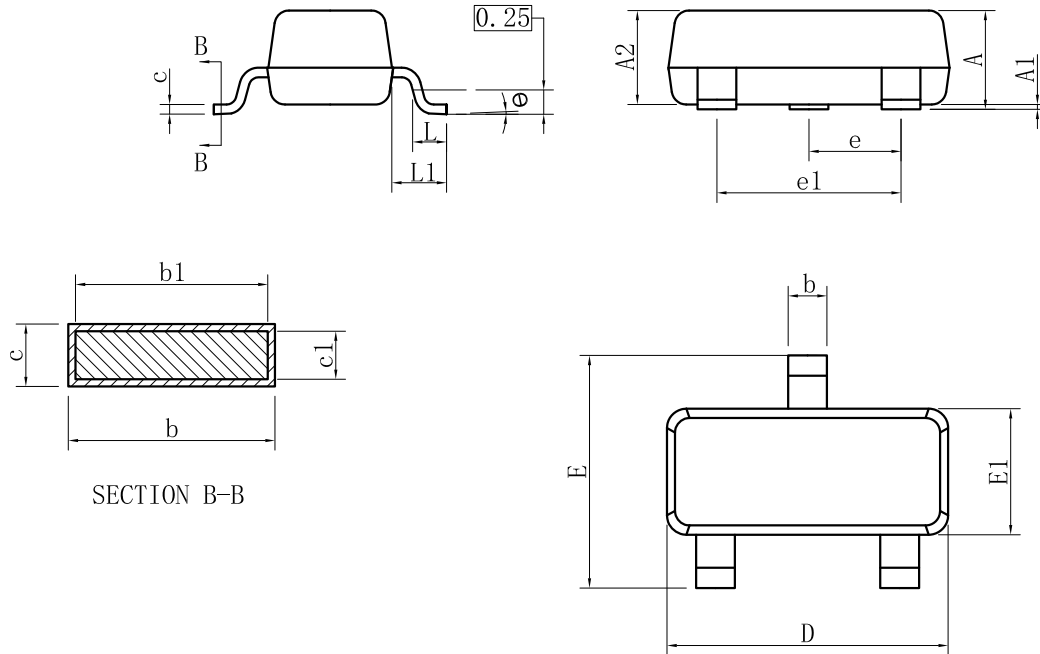

SOT23			
DIM	MIN	NOR	MAX
A	0.89	-	1.12
A1	0.01	-	0.10
A2	0.88	0.95	1.02
b	0.30	-	0.50
b1	0.30	0.40	0.45
c	0.08	-	0.20
c1	0.08	0.10	0.16
D	2.80	2.90	3.04
E	2.10	-	2.64
E1	1.20	1.30	1.40
e	0.95BSC		
e1	1.90BSC		
L	0.40	0.46	0.60
L1	0.54REF		
$\theta$	0°	-	8°
All Dimensions in mm			

#### GENERAL NOTES

- 1.Top package surface finish Ra0.4±0.2um
- 2.Bottom package surface finish Ra0.7±0.2um
- 3.Side package surface finish Ra0.4±0.2um

### 9.SOLDERING FOOTPRINT

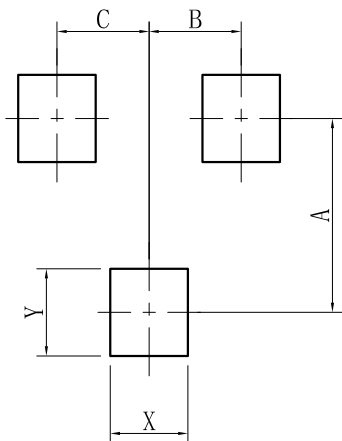

SOT-23	
DIM	(mm)
X	0.80
Y	0.90
A	2.00
B	0.95
C	0.95

## **DISCLAIMER**

- Curve guarantee in the specification. The curve of test items with electric parameter is used as quality guarantee. The curve of test items without electric parameter is used as reference only.
- Before you use our Products for new Project, you are requested to carefully read this document and fully understand its contents. LRC shall not be in any way responsible or liable for failure, malfunction or accident arising from the use of any LRC's Products against warning, caution or note contained in this document.
- All information contained in this document is current as of the issuing date and subject to change without any prior notice. Before purchasing or using LRC's Products, please confirm the latest information with a LRC sales representative.