

Dual N-Channel 30-V(D-S) MOSFET

V(BR)DSS	RDS(on)MAX	ID
30 V	55mΩ@10V	3.4A
	70mΩ@4.5V	
	90mΩ@2.5V	

FEATURE:

※ TrenchFET Power MOSFET

MARKING: HO3D XX

Equivalent Circuit:

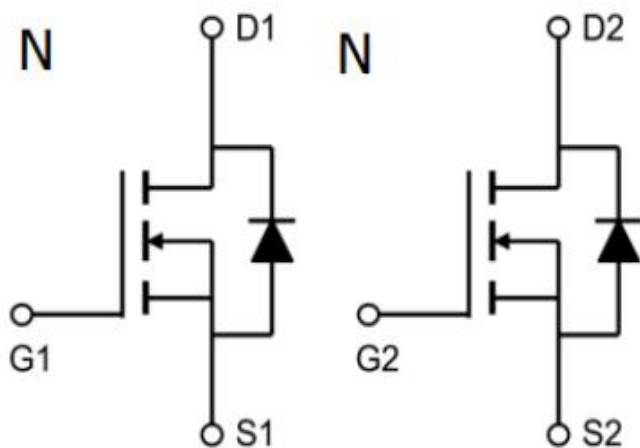

General Description:

The AO6800 uses advanced trench technology to provide excellent RDS(ON), low gate charge and operation with gate voltages as low as 2.5V. This device is suitable for use as a load switch or in PWM applications.

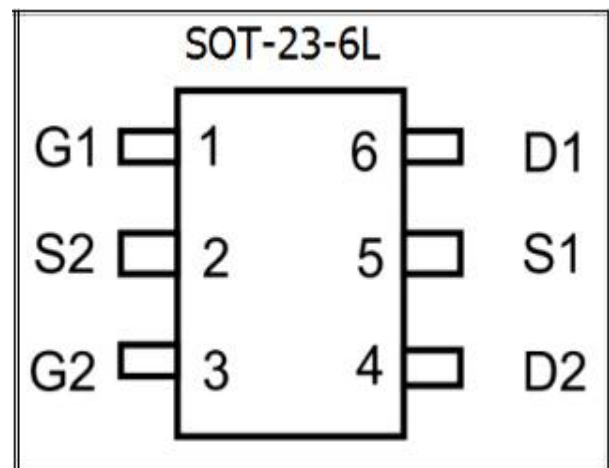

Maximum ratings (Ta=25°C unless otherwise noted)

Parameter	Symbol	Value	Unit
Drain-Source Voltage	VDS	30	V
Gate-Source Voltage	VGS	±12	
Continuous Drain Current	ID	3.4	A
Pulsed Diode Current	IDM	20	
Continuous Source-Drain Current(Diode Conduction)	IS	1.5	
Power Dissipation	PD	1.15	W
Thermal Resistance from Junction to Ambient (t≤10s)	RθJA	150	°C/W
Operating Junction	TJ	150	°C
Storage Temperature	TSTG	-55~+150	°C

MOSFET ELECTRICAL CHARACTERISTICS

Static Electrical Characteristics (Ta = 25 °C Unless Otherwise Noted)

Parameter	Symbol	Test Condition	Min	Typ	Max	Unit
Static						
Drain-source breakdown voltage	V(BR)DSS	VGS = 0V, ID = 250μA	30			V
Gate-source threshold voltage	VGS(th)	VDS = VGS, ID = 250μA	0.7		1.5	V
Gate-body leakage current	IGSS	VDS = 0V, VGS = ±12V			±100	nA
Zero gate voltage drain current	IDSS	VDS = 30V, VGS = 0V			1	μA
Static Drain-Source On-Resistance	RDS(on)	VGS = 10V, ID = 3.4A		46	55	mΩ
		VGS = 4.5V, ID = 3A		47	65	mΩ
		VGS = 2.5V, ID = 2.8A		58	80	mΩ
Forward transconductance	gfs	VDS = 5V, ID = 3.4A		14		S
Diode forward voltage	VSD	IS = 1A, VGS = 0V		0.8	1.2	V
Maximum Body-Diode Continuous Current	IS				1.5	A
Dynamic						
Input capacitance	Ciss	VDS = 15V, VGS = 0V, f = 1MHz		235		pF
Output capacitance	Coss			35		pF
Reverse transfer capacitance	Crss			17		pF
Total gate charge	Qg	VDS = 15V, VGS = 10V, ID = 3.4A		10		nC
Gate-source charge	Qgs			4.7		nC
Gate-drain charge	Qgd			0.95		nC
Gate resistance	Rg	f = 1MHz		4.4	8.8	Ω
Switching						
Turn-on delay time	td(on)	VDS = 15V, RL = 4.4Ω, ID ≈ 3.4A, VGS = 10V, Rg = 3Ω		12	20	ns
Rise time	tr			50	75	ns
Turn-off delay time	td(off)			12	20	ns
Fall time	tf			22	35	ns
Body Diode Reverse Recovery Time	Trr	IF = 3.4A, dI/dt = 100A/μs		8.5		ns
Body Diode Reverse Recovery Charge	Qrr	IF = 3.4A, dI/dt = 100A/μs		2.55		nC

Note :

1. Repetitive Rating : Pulse width limited by maximum junction temperature.
2. Surface Mounted on FR4 Board, t < 10 sec.
3. Pulse Test : Pulse Width ≤ 300μs, Duty Cycle ≤ 2%.
4. Guaranteed by design, not subject to production testing.

Typical Electrical Thermal Characteristics:

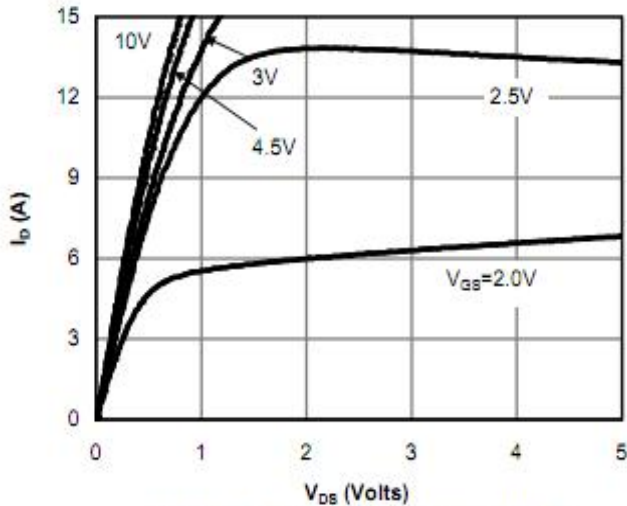

Fig 1: On-Region Characteristics (Note E)

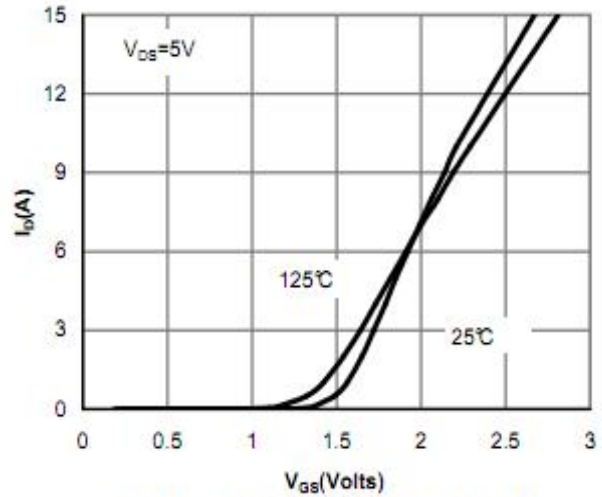

Figure 2: Transfer Characteristics (Note E)

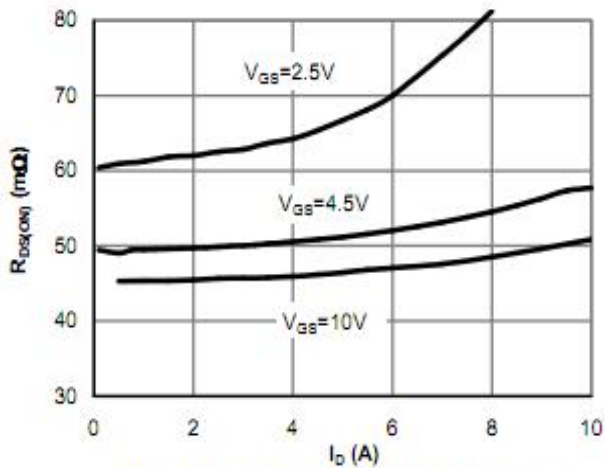

Figure 3: On-Resistance vs. Drain Current and Gate Voltage (Note E)

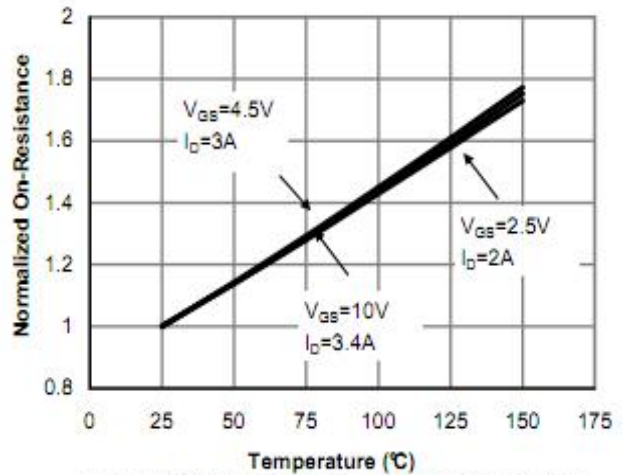

Figure 4: On-Resistance vs. Junction Temperature (Note E)

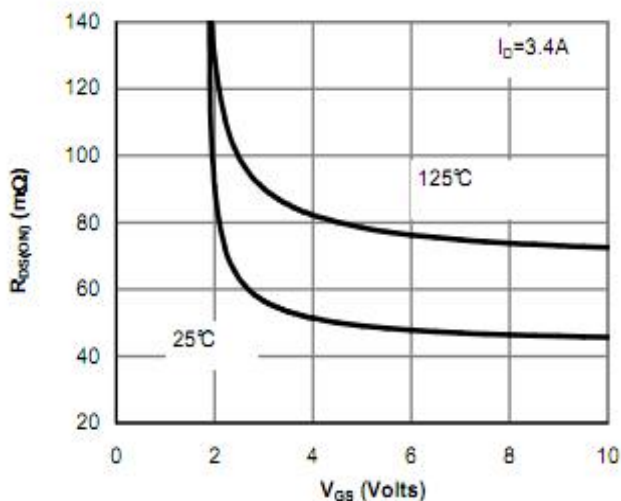

Figure 5: On-Resistance vs. Gate-Source Voltage (Note E)

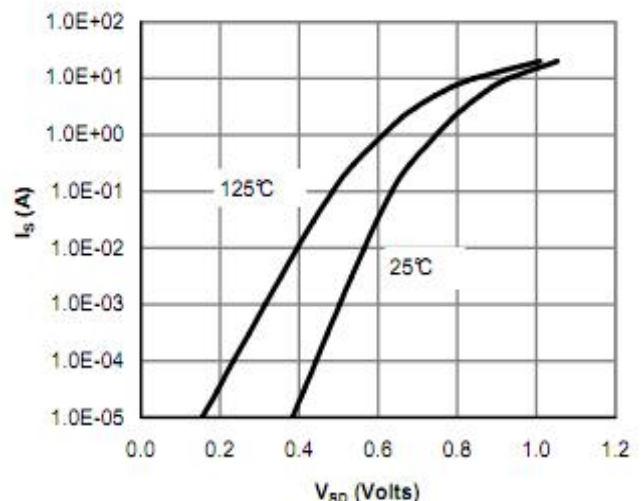

Figure 6: Body-Diode Characteristics (Note E)

Typical Electrical Thermal Characteristics:

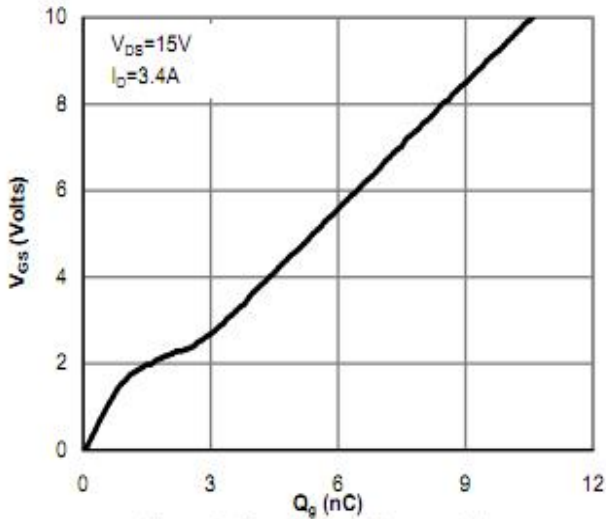

Figure 7: Gate-Charge Characteristics

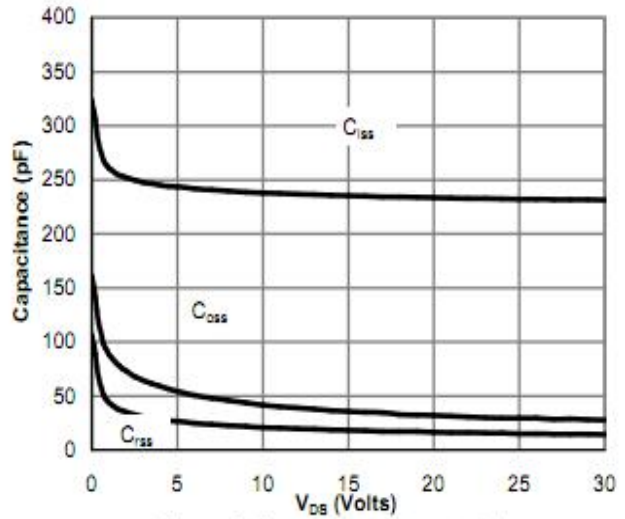

Figure 8: Capacitance Characteristics

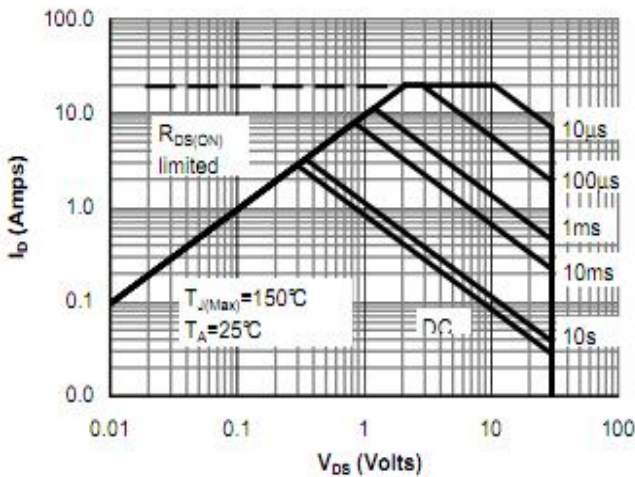

Figure 9: Maximum Forward Biased Safe Operating Area (Note F)

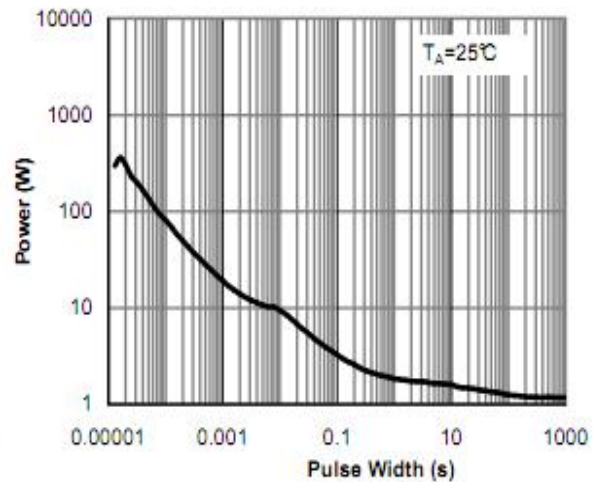

Figure 10: Single Pulse Power Rating Junction-to-Ambient (Note F)

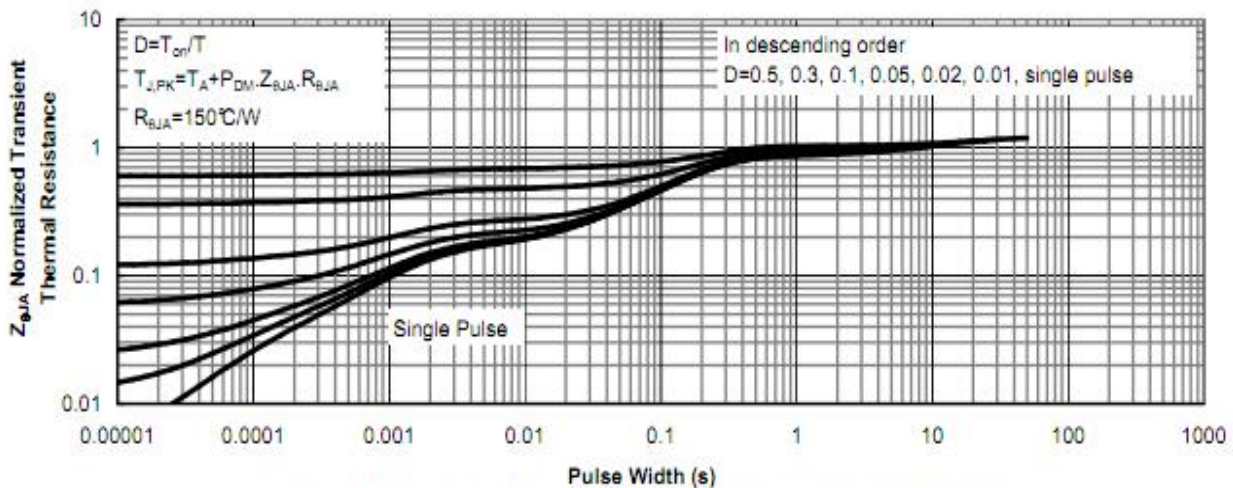
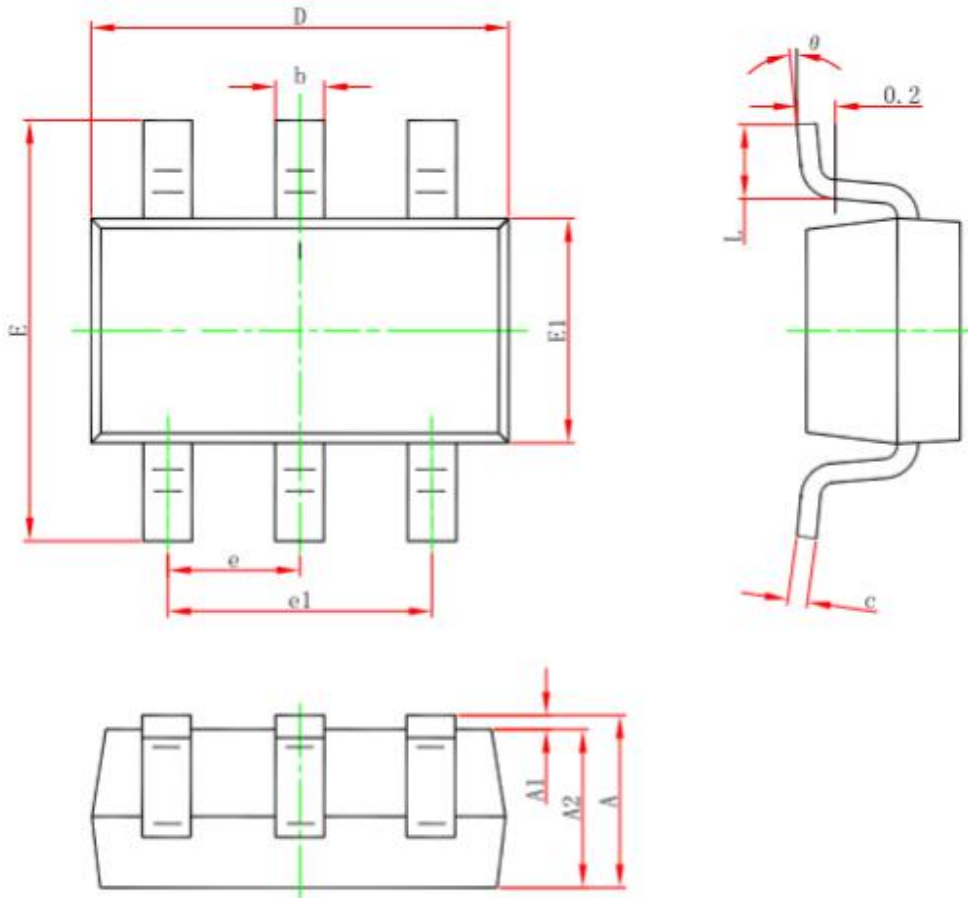

Figure 11: Normalized Maximum Transient Thermal Impedance (Note F)

SOT-23-6L PACKAGE OUTLINE DIMENSIONS:



Symbol	Dimensions In Millimeters		Dimensions In Inches	
	Min.	Max.	Min.	Max.
A	1.050	1.250	0.041	0.049
A1	0.000	0.100	0.000	0.004
A2	1.050	1.150	0.041	0.045
b	0.300	0.500	0.012	0.020
c	0.100	0.200	0.004	0.008
D	2.820	3.020	0.111	0.119
E1	1.500	1.700	0.059	0.067
E	2.650	2.950	0.104	0.116
e	0.950(BSC)		0.037(BSC)	
e1	1.800	2.000	0.071	0.079
L	0.300	0.600	0.012	0.024
theta	0°	8°	0°	8°