

Type RA73 Series

Key Features

High thermal conductivity
Aluminum-Nitride substrate.

High Power / Size ratio – Up to 1W in 0805 size.

Thin film precision resistors with TCR to 25ppm and tolerances to 0.1%.



Applications

Power Supplies

Power Switching

Braking Systems

TE are pleased to introduce the new RA73 series. This is a high stability precision Thin Film chip resistor range offering very high power / size ratio – up to 1W in 0805 size. The RA73 series offers TCR down to 25ppm/°C and resistance tolerances to 0.1%. Standard values are within the IEC 63 E96 and E24 value grids. The RA73 resistors have accurate and uniform physical dimensions to facilitate automatic placement methods.

Electrical Characteristics

Chip Size	0603								
Rated Power @70°C	0.5W								
Resistance Range Ω	Min.	50R	50R	50R	50R	50R	50R	50R	50R
	Max	30K1	30K1	30K1	30K1	30K1	30K1	30K1	30K1
Tolerance	0.1		0.25		0.50		1		
Code Letter	B		C		D		F		
Selection series	E24 & E96								
Temp. Coefficient (ppm/°C)	25	50	25	50	25	50	25	50	
Code Letter	F	G	F	G	F	G	F	G	
Operating Voltage (Max)	75V								
Max. Overload Voltage	150V								
Operating Temp. Range	-55 ~ +155°C								
Insulation Resistance dry min.	>9999MΩ								
Stability	1%								

Power rating Dependant on component mounting by user



Chip Size	0805								
Rated Power @70°C	1W								
Resistance Range Ω	Min.	50R	50R	50R	50R	50R	50R	50R	50R
	Max	30.1K	30.1K	30.1K	30.1K	30.1K	30.1K	30.1K	30.1K
Tolerance	0.1			0.25		0.50		1	
Code Letter	B			C		D		F	
Selection series	E24 & E96								
Temp. Coefficient (ppm/°C)	25	50	25	50	25	50	25	50	
Code Letter	F	G	F	G	F	G	F	G	
Operating Voltage (Max)	100V								
Max. Overload Voltage	200V								
Operating Temp. Range	-55 ~ +155°C								
Insulation Resistance dry min.	>9999MΩ								
Stability	1%								

Power rating Dependant on component mounting by user

Operating Voltage= $\sqrt{P \cdot R}$ or Max. Operating voltage listed above, whichever is lower

Environmental Characteristics

Item	Requirement	Test Method
Temperature Coefficient of Resistance (TCR)	As per TCRs specified in Electrical Characteristics tables	MIL-STD-202 Method 304 +25/-55/+25/+125/+25°C
Short Time Overload	$\Delta R \pm 0.5\%$	Actual power handling capability is limited by the end user mounting process. As with any high power chip resistor the ability to remove the heat is critical to the overall performance of the device.
Insulation Resistance	>9999 MΩ	MIL-STD-202 Method 302 Apply 100VDC for 1 minute
Endurance	$\Delta R \pm 0.1\%$	MIL-STD-202 Method 108 70±2°C, RCWV for 1000 hrs with 1.5 hrs "ON" and 0.5 hrs "OFF"
Damp Heat with Load	$\Delta R \pm 0.4\%$	MIL-STD-202 Method 103 40±2°C, 90~95% R.H. RCWV for 1000 hrs with 1.5 hrs "ON" and 0.5 hrs "OFF"
Solderability	95% min. coverage	MIL-STD-202 Method 208 245±5°C for 3 seconds
Resistance to Soldering Heat	$\Delta R \pm 0.2\%$	MIL-STD-202 Method 210E 260±5°C for 10 seconds
Low Temperature Operation	$\Delta R \pm 0.2\%$	JIS-C-5201-1 4.36 1 hour, -65°C, followed by 45 minutes of RCWV
High Temperature Exposure	$\Delta R \pm 0.2\%$	MIL-STD-202 Method 108 At +155°C for 1000 hours
Thermal Shock	$\Delta R \pm 0.2\%$	MIL-STD-202F Method 107 -55°C ~ 150°C, 100 cycles

RCWV(Rated continuous working voltage)= $\sqrt{P \cdot R}$ or Max. Operating voltage whichever is lower

Reference Standards: MIL-SRD-202, JIS-C 5201

Storage Temperature: 25±3°C; Humidity < 80%RH

Derating Curve

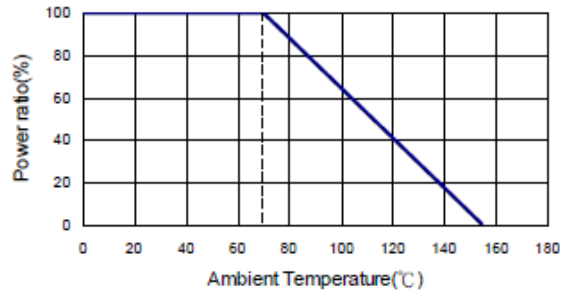

Construction and Dimensions

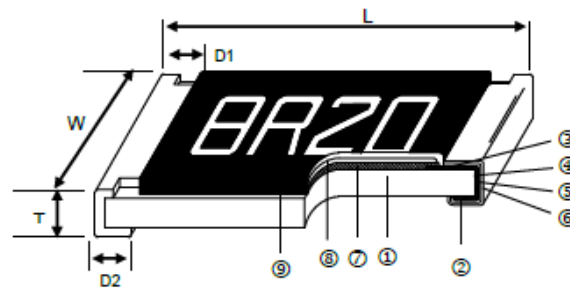

① Alumina Nitride Substrate	④ Edge Electrode	⑦ Resistor Layer
② Bottom Electrode	⑤ Barrier Layer	⑧ Overcoat
③ Top Electrode	⑥ External Electrode	⑨ Marking

Size	L (mm)	W (mm)	T (mm)	D1 (mm)	D2 (mm)	Weight (g) (1000 Pcs.)
0603	1.55±0.10	0.80±0.10	0.43±0.15	0.30±0.15	0.50±0.20	1.73
0805	2.00±0.15	1.25±0.15	0.43±0.15	0.35±0.15	0.60±0.20	3.95

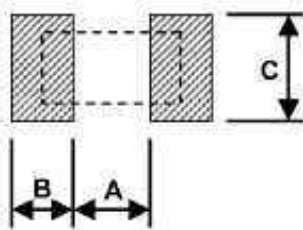

Recommended Land Pattern			
Size	A	B	C
0603	0.37	0.99	0.86±0.1
0805	0.50	1.08	1.32±0.1

Use a board with a copper thickness of two ounces



Marking

Case size 0805 IEC 4 Digit Marking:

Resistance	500R (500Ω)	2K2 (2.2kΩ)	10K (10kΩ)	12.5K (12.5kΩ)
Code	5000	2201	1002	1252

Case Size 0603 E24 3 digit marking – Example 101 = 100R 102=1K0

E24	10	11	12	13	15	16	18	20	22	24	27	30
	33	36	39	43	47	51	56	62	68	75	82	91

Case size 0603 E96 3 digit marking – Examples 14C = 13K7 68B = 4K99 68X = 49R9

Code	E96	Code	E96	Code	E96	Code	E96
01	100	25	178	49	316	73	562
02	102	26	182	50	324	74	576
03	105	27	187	51	332	75	590
04	107	28	191	52	340	76	604
05	110	29	196	53	348	77	619
06	113	30	200	54	357	78	634
07	115	31	205	55	365	79	649
08	118	32	210	56	374	80	665
09	121	33	215	57	383	81	681
10	124	34	221	58	392	82	698
11	127	35	226	59	402	83	715
12	130	36	232	60	412	84	732
13	133	37	237	61	422	85	750
14	137	38	243	62	432	86	768
15	140	39	249	63	442	87	787
16	143	40	255	64	453	88	806
17	147	41	261	65	464	89	825
18	150	42	267	66	475	90	845
19	154	43	274	67	487	91	866
20	158	44	280	68	499	92	887
21	162	45	287	69	511	93	909
22	165	46	294	70	523	94	931
23	169	47	301	71	536	95	953
24	174	48	309	72	549	96	976

Code	A	B	C	D	E	F	G	H	X	Y	Z
Multiplier	10 ⁰	10 ¹	10 ²	10 ³	10 ⁴	10 ⁵	10 ⁶	10 ⁷	10 ⁻¹	10 ⁻²	10 ⁻³

Requests for non E24 and E96 values will be looked at and evaluated on a case by case basis, and where offered will be unmarked

Packaging

Packing Quantity and Reel Specification

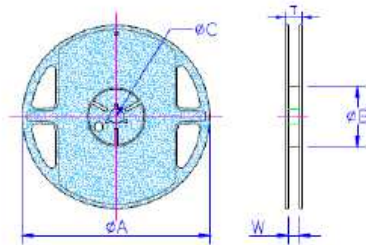

Size	$\varnothing A \pm 1.0$	$\varnothing B \pm 1.0$	$\varnothing C \pm 0.7$	$W \pm 1.0$	$T \pm 1.0$	Paper Tape	Embossed Plastic Tape
0603	178.0	60.0	13.5	9.5	11.5	1000 / 5000	-
0805							

Paper tape Specification

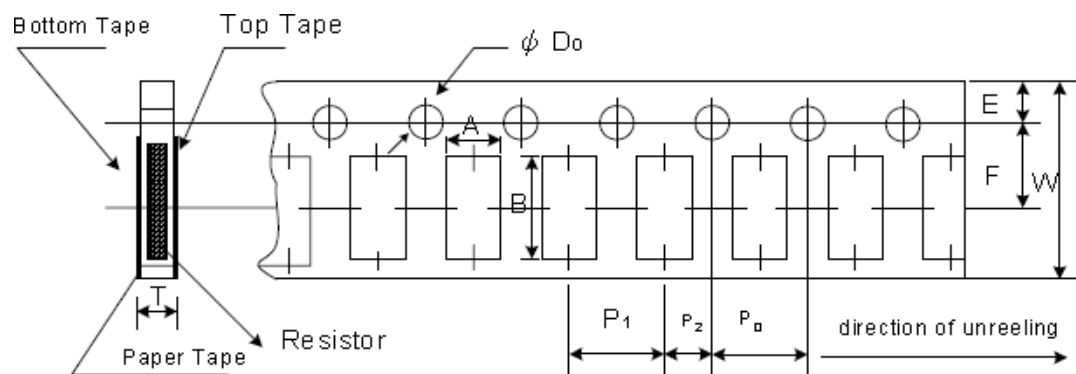

Size	A ± 0.05	B ± 0.05	W ± 0.10	E ± 0.05	F ± 0.05	P_0	P_1	P_2	$\varnothing D_0$	T
0603	1.10	1.90	8.00	1.75	3.5	4.00 ± 0.10	4.00 ± 0.10	2.00 ± 0.05	1.55 ± 0.05	0.60 ± 0.03
0805	1.60	2.37								0.75 ± 0.05

Peel force of top cover tape

The peel speed shall be about 300mm/min $\pm 5\%$

The peel force of top cover tape shall be between 8gf to 60gf

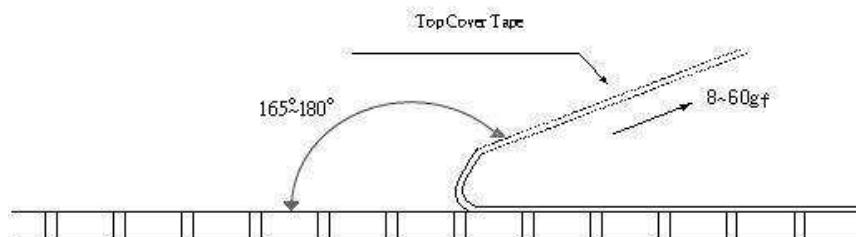

Reflow Solder Profile

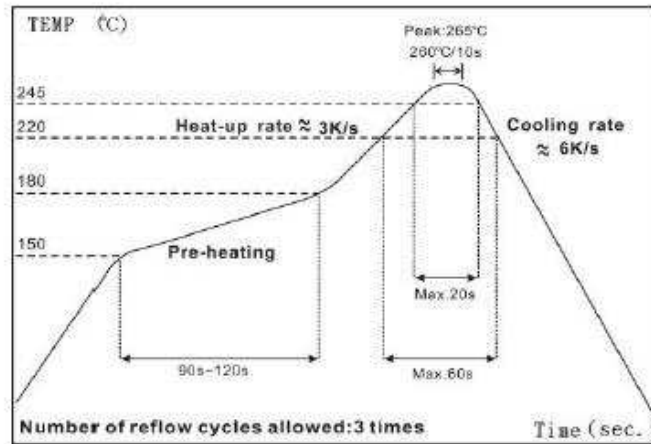

Time of Reflow soldering at maximum temperature point 260°C = 10s

Wave Solder Profile

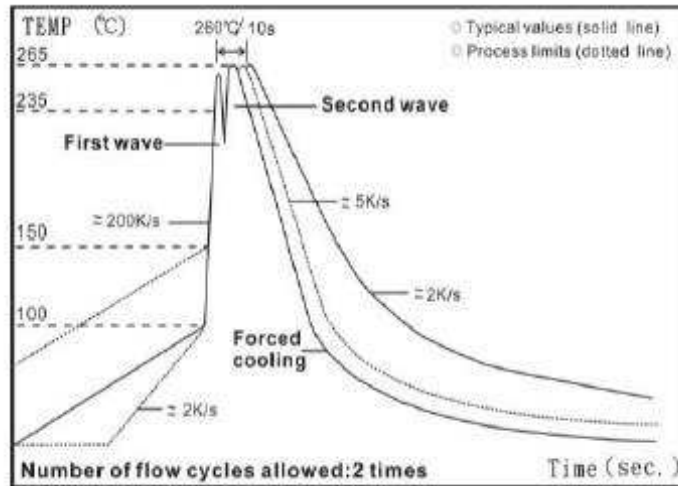

Time of Wave soldering at maximum temperature point 260°C = 10s

Time of Soldering Iron at maximum temperature point 410°C = 5s

How To Order

RA73	F	1J	100R	B	TD
Common Part	TCR	Package Size	Value	Tolerance	Packaging
RA73 – Aluminum Nitride precision thin film chip resistor	F - 25PPM G - 50PPM	1J:0603 2A:0805	100R - 100Ω 1K0 - 1000Ω 10K - 10,000Ω	B - ±0.1% C - ±0.25% D - ±0.5% F - ±1%	TDF – 1K Reel TD – 5K Reel