

Bias Resistor Transistor

PNP Silicon Surface Mount Transistor with Monolithic Bias Resistor Network

● **Applications**

Inverter, Interface, Driver

● **Features**

- 1) Built-in bias resistors enable the configuration of an inverter circuit without connecting external input resistors (see equivalent circuit).
- 2) The bias resistors consist of thin-film resistors with complete isolation to allow positive biasing of the input. They also have the advantage of almost completely eliminating parasitic effects.
- 3) Only the on / off conditions need to be set for operation, making the device design easy.

- We declare that the material of product compliance with RoHS requirements.

- S- Prefix for Automotive and Other Applications Requiring Unique Site and Control Change Requirements; AEC-Q101 Qualified and PPAP Capable

LDTB123YLT1G
S-LDTB123YLT1G

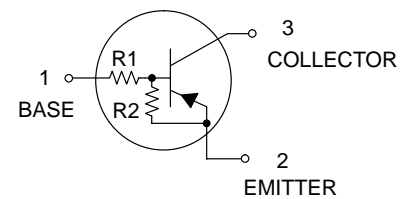
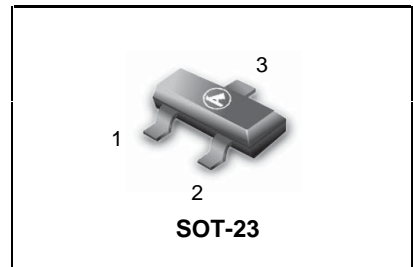

● **Absolute maximum ratings** (Ta=25°C)

Parameter	Symbol	Limits	Unit
Supply voltage	V _{CC}	-50	V
Input voltage	V _{IN}	-12 to +5	V
Output current	I _C	-500	mA
Power dissipation	P _D	200	mW
Junction temperature	T _J	150	°C
Storage temperature	T _{stg}	-55 to +150	°C

DEVICE MARKING AND RESISTOR VALUES

Device	Marking	R1 (K)	R2 (K)	Shipping
LDTB123YLT1G S-LDTB123YLT1G	F52	2.2	10	3000/Tape & Reel
LDTB123YLT3G S-LDTB123YLT3G	F52	2.2	10	10000/Tape & Reel

● **Electrical characteristics** (Ta=25°C)

Parameter	Symbol	Min.	Typ.	Max.	Unit	Conditions
Input voltage	V _{I(off)}	-	-	-0.3	V	V _{CC} = -5V, I _O = -100μA
	V _{I(on)}	-2	-	-		V _O = -0.3V, I _O = -20mA
Output voltage	V _{O(on)}	-	-0.1	-0.3	V	I _O /I _I = -50mA/-2.5mA
Input current	I _I	-	-	-3.0	mA	V _I = -5V
Output current	I _{O(off)}	-	-	-0.5	μA	V _{CC} = -50V, V _I = 0V
DC current gain	G _I	56	-	-	-	V _O = -5V, I _O = -50mA
Input resistance	R ₁	1.54	2.2	2.86	kΩ	-
Resistance ratio	R ₂ /R ₁	3.6	4.5	5.5	-	-
Transition frequency	f _T	-	200	-	MHz	V _{CE} = -10V, I _E = 50mA, f= 100MHz *

* Transition frequency of the device

LDTB123YLT1G,S-LDTB123YLT1G

●Electrical characteristic curves

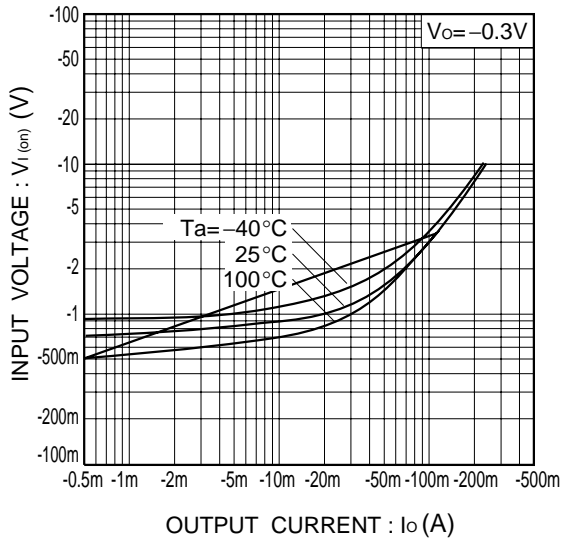

Fig.1 Input voltage vs. output current (ON characteristics)

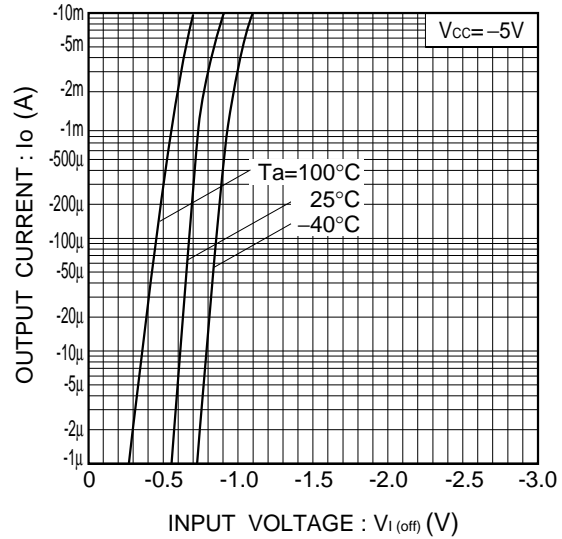

Fig.2 Output current vs. input voltage (OFF characteristics)

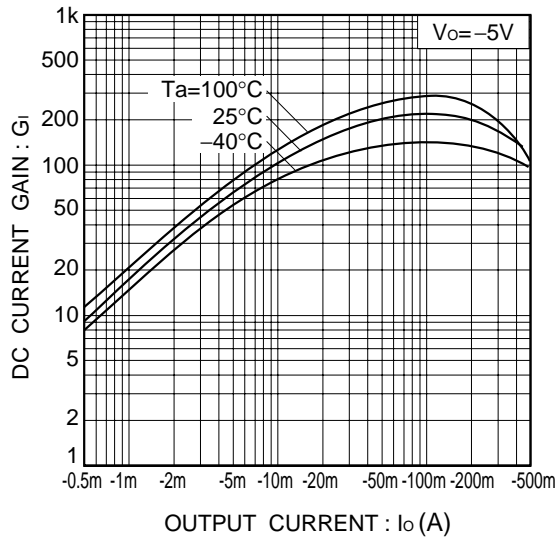

Fig.3 DC current gain vs. output current

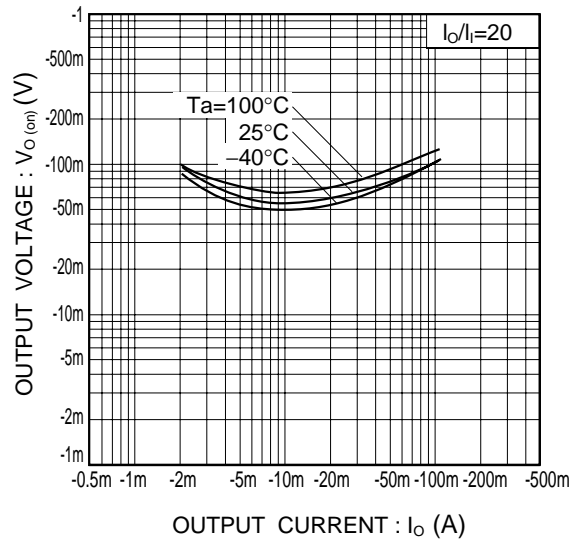
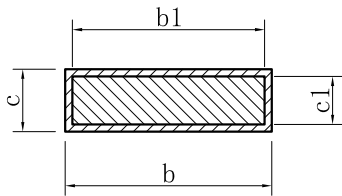
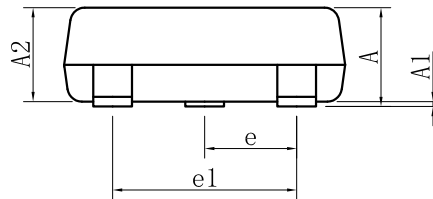
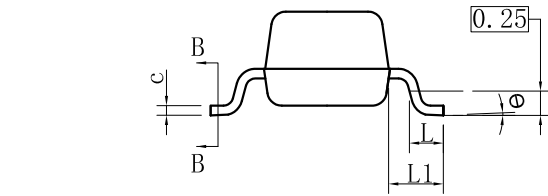

Fig.4 Output voltage vs. output current

LDTB123YLT1G,S-LDTB123YLT1G

OUTLINE AND DIMENSIONS



SECTION B-B

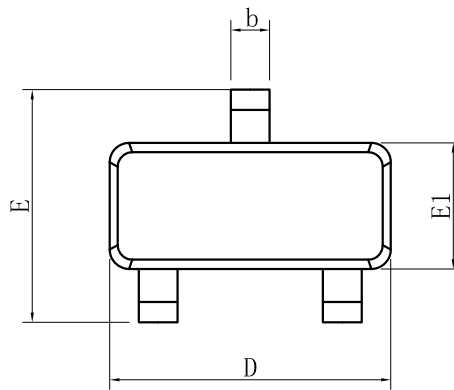

SOT23			
DIM	MIN	NOR	MAX
A	0.89	-	1.12
A1	0.01	-	0.10
A2	0.88	0.95	1.02
b	0.30	-	0.50
b1	0.30	0.40	0.45
c	0.08	-	0.20
c1	0.08	0.10	0.16
D	2.80	2.90	3.04
E	2.10	-	2.64
E1	1.20	1.30	1.40
e	0.95BSC		
e1	1.90BSC		
L	0.40	0.46	0.60
L1	0.54REF		
θ	0°	-	8°
All Dimensions in mm			

GENERAL NOTES

1. Top package surface finish Ra0.4±0.2um
2. Bottom package surface finish Ra0.7±0.2um
3. Side package surface finish Ra0.4±0.2um

SOLDERING FOOTPRINT

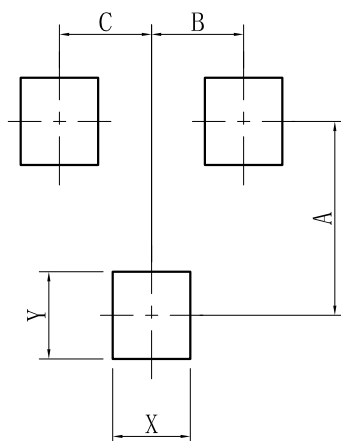

SOT-23	
DIM	(mm)
X	0.80
Y	0.90
A	2.00
B	0.95
C	0.95

DISCLAIMER

- Curve guarantee in the specification. The curve of test items with electric parameter is used as quality guarantee. The curve of test items without electric parameter is used as reference only.
- Before you use our Products for new Project, you are requested to carefully read this document and fully understand its contents. LRC shall not be in any way responsible or liable for failure, malfunction or accident arising from the use of any LRC's Products against warning, caution or note contained in this document.
- All information contained in this document is current as of the issuing date and subject to change without any prior notice. Before purchasing or using LRC's Products, please confirm the latest information with a LRC sales representative.