

N-Channel 100V (D-S) MOSFET

GENERAL DESCRIPTION

The ME2614 is the N-Channel logic enhancement mode power field effect transistors are produced using high cell density, DMOS trench technology. This high density process is especially tailored to minimize on-state resistance. These devices are particularly suited for low voltage application such as cellular phone and notebook computer power management and other battery powered circuits where high-side switching, and low in-line power loss are needed in a very small outline surface mount package.

FEATURES

- $R_{DS(ON)} \leq 166m\Omega @ V_{GS}=10V$
- $R_{DS(ON)} \leq 213m\Omega @ V_{GS}=4.5V$
- Super high density cell design for extremely low $R_{DS(ON)}$
- Exceptional on-resistance and maximum DC current capability

APPLICATIONS

- DC/DC Converter
- Load Switch

PIN CONFIGURATION

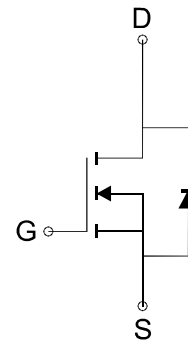
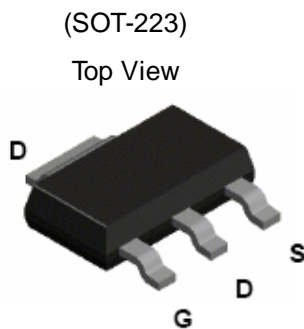

N-Channel MOSFET

Ordering Information: ME2614 (Pb-free)

ME2614-G (Green product-Halogen free)

Absolute Maximum Ratings (TA=25°C Unless Otherwise Noted)

Parameter	Symbol	Maximum Ratings	Unit
Drain-Source Voltage	V_{DS}	100	V
Gate-Source Voltage	V_{GS}	± 20	V
Continuous Drain Current	I_D	$T_A=25^\circ C$	3.3
		$T_A=70^\circ C$	2.6
Pulsed Drain Current	I_{DM}	13	A
Maximum Power Dissipation	P_D	$T_A=25^\circ C$	2.9
		$T_A=70^\circ C$	1.9
Operating Junction Temperature	T_J	150	$^\circ C$
Storage Temperature Range	T_{stg}	-55 to 150	$^\circ C$
Thermal Resistance-Junction to Ambient	$R_{\theta JA}$	42	$^\circ C/W$

*The device mounted on 1in² FR4 board with 2 oz copper

DCC
正式發行

N-Channel 100V (D-S) MOSFET

Electrical Characteristics (TA=25°C Unless Otherwise Specified)

Symbol	Parameter	Limit	Min	Typ	Max	Unit
STATIC						
V _{BR(DSS)}	Drain-Source Breakdown Voltage	V _{GS} =0V, I _D =250 μA	100			V
V _{GS(th)}	Gate Threshold Voltage	V _{DS} =V _{GS} , I _D =250 μA	1.0		3.0	V
I _{GSS}	Gate Leakage Current	V _{DS} =0V, V _{GS} =±20V			±100	nA
I _{DSS}	Zero Gate Voltage Drain Current	V _{DS} =80V, V _{GS} =0V			1	μA
R _{DS(ON)}	Drain-Source On-Resistance ^a	V _{GS} =10V, I _D =3A		140	166	mΩ
		V _{GS} =4.5V, I _D =2.4A		165	213	
V _{SD}	Diode Forward Voltage	I _S =2.5A, V _{GS} =0V		0.8	1.2	V
DYNAMIC						
Q _g	Total Gate Charge	V _{DS} =80V, V _{GS} =10V, I _D =2.5A		19.2		nC
Q _g	Total Gate Charge	V _{DS} =80V, V _{GS} =4.5V, I _D =2.5A		11.2		
Q _{gs}	Gate-Source Charge			3.4		
Q _{gd}	Gate-Drain Charge			6.1		
C _{iss}	Input capacitance	V _{DS} =15V, V _{GS} =0V, f=1.0MHz		849		pF
C _{oss}	Output Capacitance			57		
C _{rss}	Reverse Transfer Capacitance			44		
t _{d(on)}	Turn-On Delay Time	V _{DS} =50V, R _L =10Ω V _{GS} =10V, R _G =6Ω I _D =5A		12.6		ns
t _r	Turn-On Rise Time			6		
t _{d(off)}	Turn-Off Delay Time			32.5		
t _f	Turn-Off Fall Time			4.3		

Notes: a. Pulse test: pulse width ≤ 300us, duty cycle ≤ 2%, Guaranteed by design, not subject to production testing.

b. Matsuki Electric/ Force mos reserves the right to improve product design, functions and reliability without notice.

DCC
正式發行

N-Channel 100V (D-S) MOSFET

Typical Characteristics (T_J =25°C Noted)

On Resistance vs. Junction Temperature

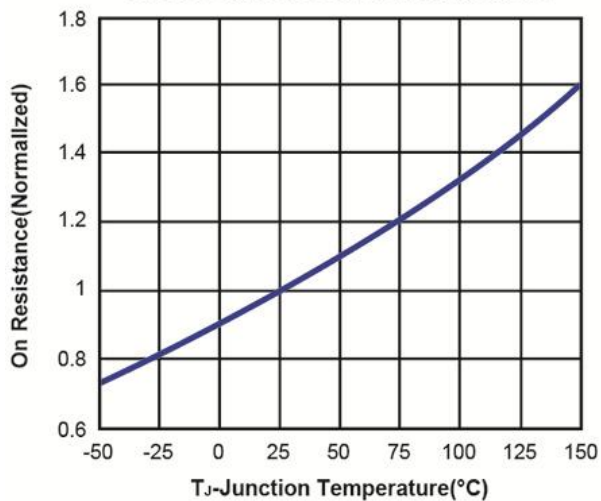

On Resistance vs. Drain Current

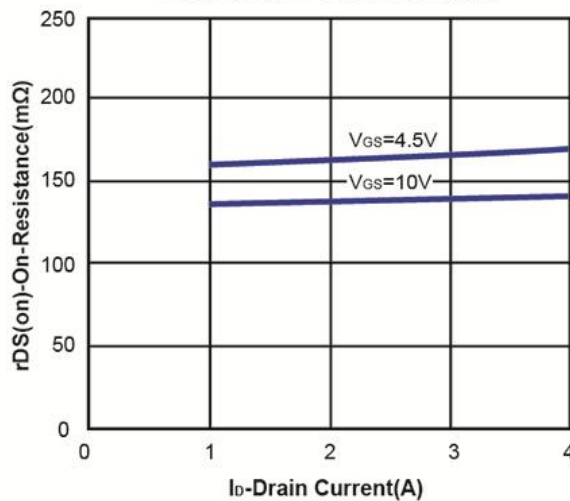

Capacitance

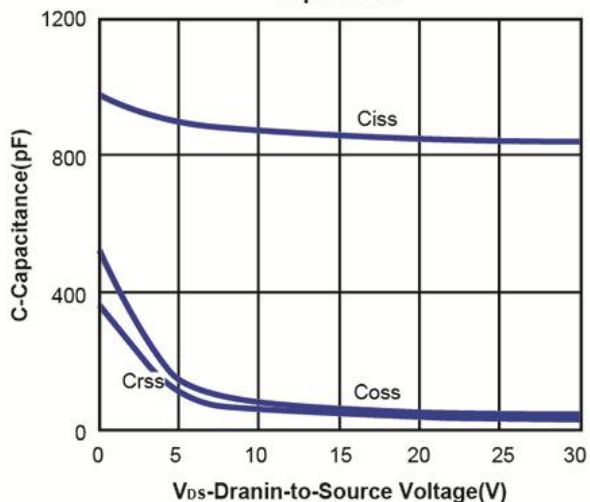

On Resistance vs. Gate-to-Source Voltage

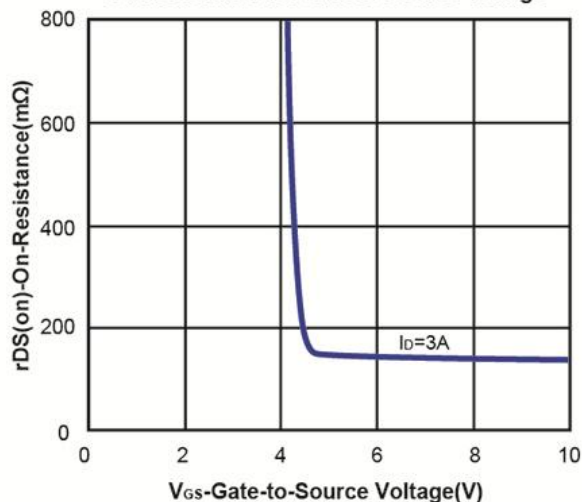

Threshold Voltage

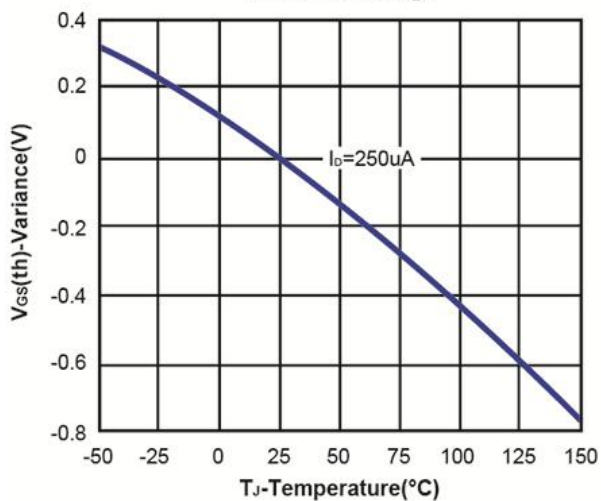

On-Region Characteristics

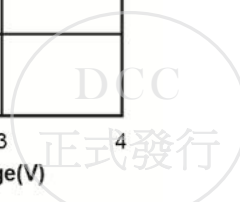
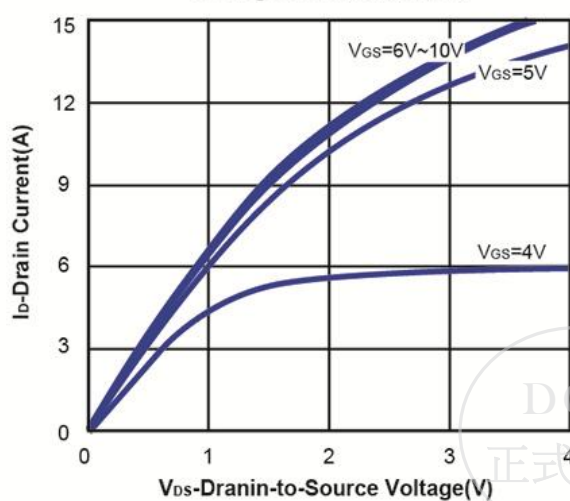

N-Channel 100V (D-S) MOSFET

Typical Characteristics (T_J =25°C Noted)

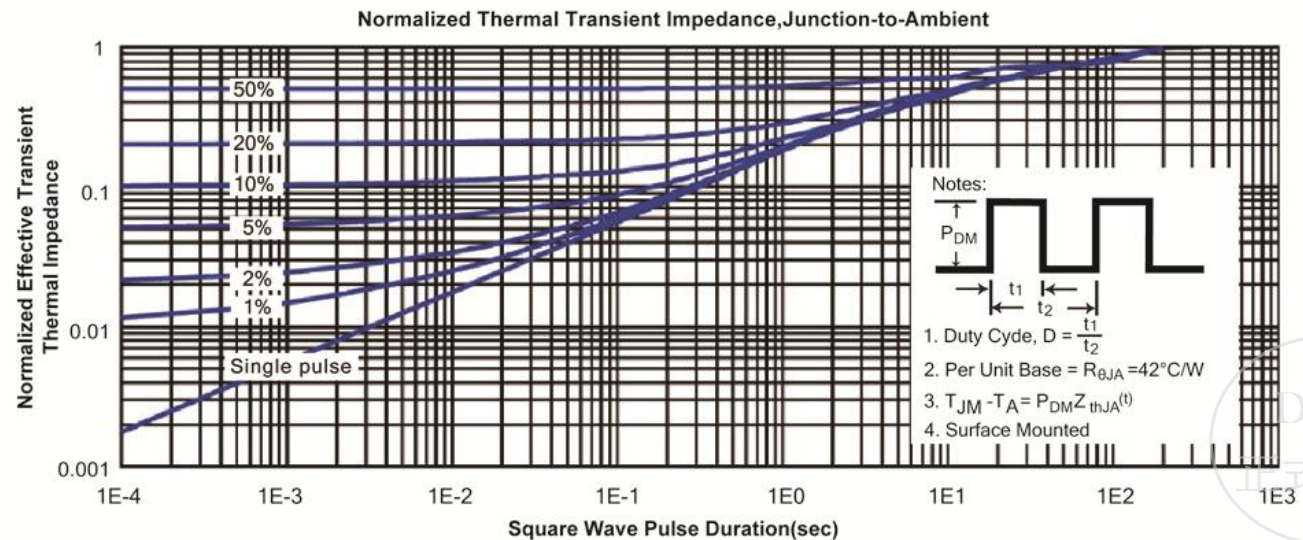
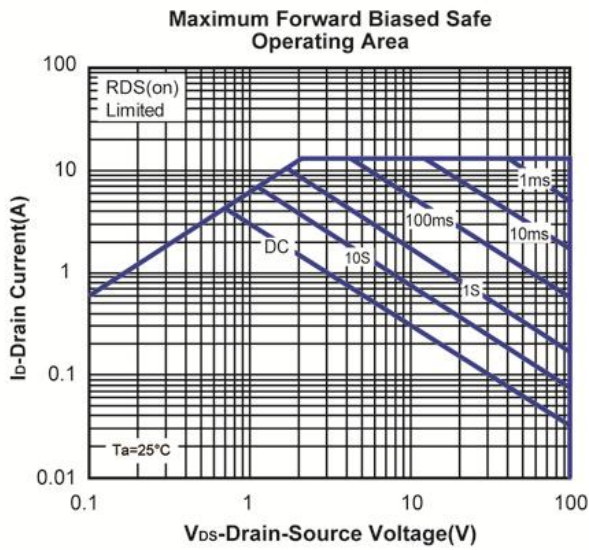
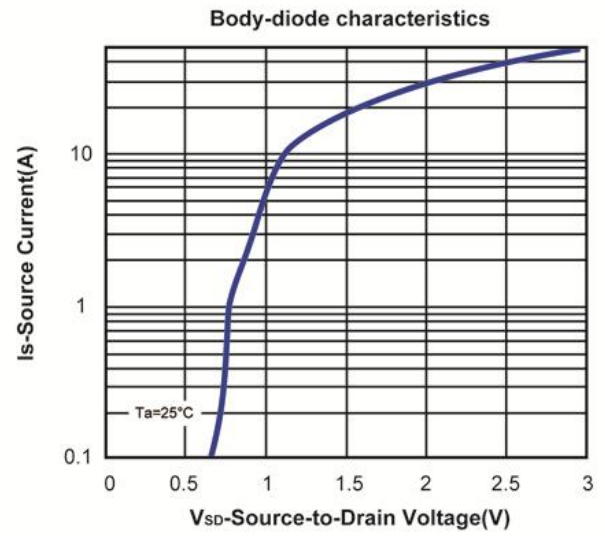
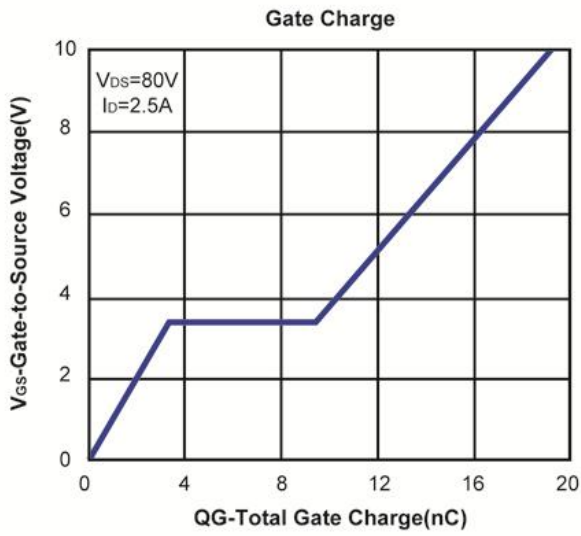

SOT-223-3L Package Outline

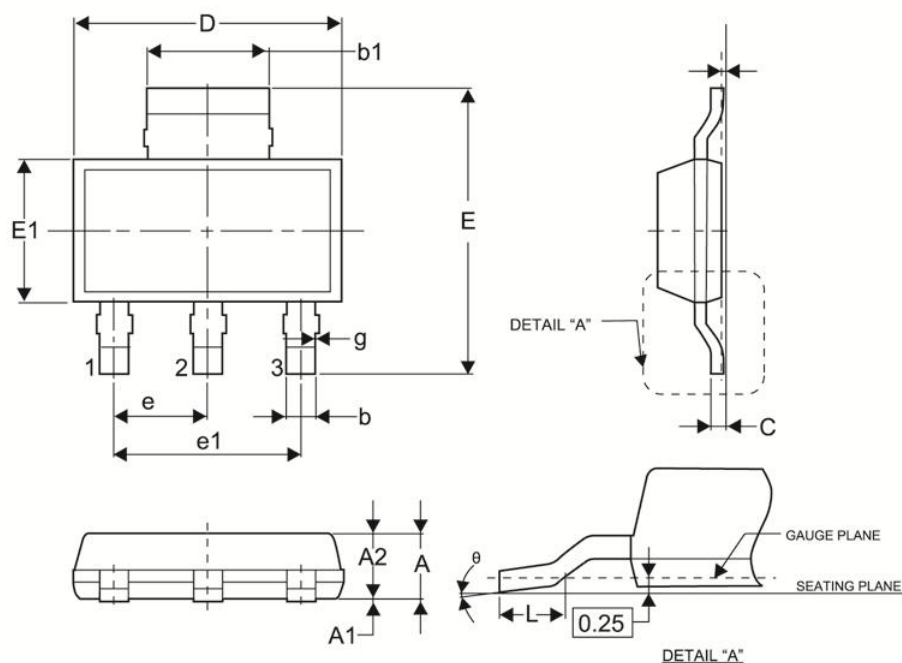

Symbol	DIMENSIONS MILLIMETERS	
	MIN	MAX
A	-	1.80
A1	0.02	0.10
A2	1.50	1.70
b	0.66	0.84
b1	2.90	3.10
g	-	0.06
C	0.23	0.35
D	6.30	6.70
E	6.70	7.30
E1	3.30	3.70
e	2.30 BSC	
e1	4.60 BSC	
L	0.81	-
θ	0°	10°

