

CPF0402B82R5E1 ✓ ACTIVE

Neohm | Neohm CPF

TE Internal #: 4-1879213-8

82.5 Ω , Thin Film, Precision Resistor, .1 %, 2 Termination, 0402, Taped & Reeled, .063 W, ± 25 ppm/ $^{\circ}\text{C}$, Solder, Height .012 in [.3 mm], Neohm CPF

[View on TE.com >](#)



Passive Components > Resistors > Surface Mount Resistors



Resistor Type: **Precision Resistor**

Number of Terminations: **2**

Package Size Code: **0402**

Packaging Method: **Taped & Reeled**

Passive Component Tolerance: **.1 %**

Features

Product Type Features

Resistor Type	Precision Resistor
Package Size Code	0402
Element Type	Thin Film

Configuration Features

Number of Resistors	1
---------------------	---

Electrical Characteristics

Operating Voltage	25 V
Passive Component Tolerance	.1 %
Resistance Class	Up to 1k Ω
Resistance Value	82.5 Ω
Power Rating	.063 W

Termination Features

Number of Terminations	2
Surface Mount Resistor Termination Type	Solder

Dimensions

Product Height	.3 mm[.012 in]
Product Length	1 mm[.039 in]
Product Width	.5 mm[.02 in]



Usage Conditions

Temperature Coefficient	±25 ppm/°C
-------------------------	------------

Packaging Features

Packaging Method	Taped & Reeled
------------------	----------------

Product Compliance

[For compliance documentation, visit the product page on TE.com>](#)

EU RoHS Directive 2011/65/EU	Compliant
EU ELV Directive 2000/53/EC	Compliant
China RoHS 2 Directive MIIT Order No 32, 2016	No Restricted Materials Above Threshold
EU REACH Regulation (EC) No. 1907/2006	Current ECHA Candidate List: JUNE 2023 (235) Candidate List Declared Against: JUNE 2023 (235) Does not contain REACH SVHC
Halogen Content	Low Halogen - Br, Cl, F, I < 900 ppm per homogenous material. Also BFR/CFR/PVC Free
Solder Process Capability	Reflow solder capable to 260°C

Product Compliance Disclaimer

This information is provided based on reasonable inquiry of our suppliers and represents our current actual knowledge based on the information they provided. This information is subject to change. The part numbers that TE has identified as EU RoHS compliant have a maximum concentration of 0.1% by weight in homogenous materials for lead, hexavalent chromium, mercury, PBB, PBDE, DBP, BBP, DEHP, DIBP, and 0.01% for cadmium, or qualify for an exemption to these limits as defined in the Annexes of Directive 2011/65/EU (RoHS2). Finished electrical and electronic equipment products will be CE marked as required by Directive 2011/65/EU. Components may not be CE marked. Additionally, the part numbers that TE has identified as EU ELV compliant have a maximum concentration of 0.1% by weight in homogenous materials for lead, hexavalent chromium, and mercury, and 0.01% for cadmium, or qualify for an exemption to these limits as defined in the Annexes of Directive 2000/53/EC (ELV). Regarding the REACH Regulation, the information TE provides on SVHC in articles for this part number is based on the latest European Chemicals Agency (ECHA) 'Guidance on requirements for substances in articles' posted at this URL: <https://echa.europa.eu/guidance-documents/guidance-on-reach>

Compatible Parts

<p>TE Part # 3-1879216-5 CPF0402 200K 0.1% 25PPM 1K RL</p>	<p>TE Part # 1-1879417-9 CPF 0603 1M0 0.1% 25PPM 1K RL</p>	<p>TE Part # 1879417-8 CPF0603 1M0 0.1% 25PPM 5K RL</p>	<p>TE Part # 1-1614959-4 CPF0805 2M0 0.1% 25PPM 1K RL</p>
--	--	---	---



Also in the Series | Neohm CPF



Customers Also Bought

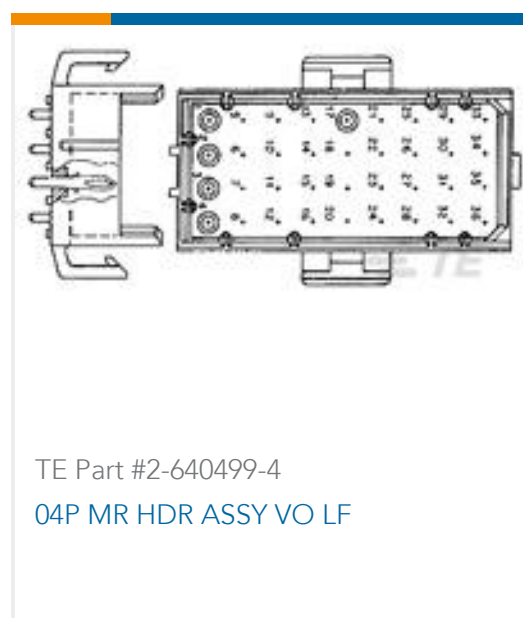
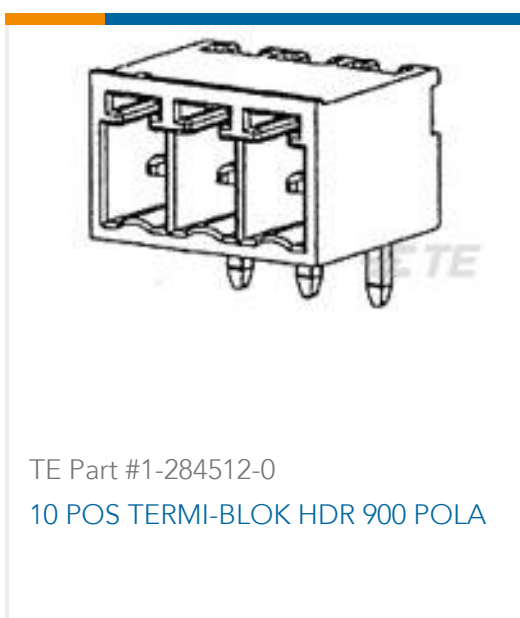



Documents

Product Drawings

[CPF 0402 82R5 0.1% 25PPM 1K RL](#)

English

CAD Files

[3D PDF](#)

3D

Customer View Model

[ENG_CVM_CVM_4-1879213-8_BA.2d_dxf.zip](#)

English

Customer View Model

[ENG_CVM_CVM_4-1879213-8_BA.3d_igs.zip](#)

English

Customer View Model

[ENG_CVM_CVM_4-1879213-8_BA.3d_stp.zip](#)

English

By downloading the CAD file I accept and agree to the [Terms and Conditions](#) of use.

Datasheets & Catalog Pages

[1309350_PASSIVE_COMPONENT](#)

English

[CPF-1016](#)

English

[8-1773459-4_POWER_FILTERING_AND_RESISTIVE_SOLUTIONS_FOR_ELEVATORS_AND_ESCALATORS](#)

English