

SMA-A0207BTNT220R ✓ ACTIVE

Neohm | Neohm SMA-A

TE Internal #: 2176316-5

220 Ω , Thin Film, Precision Resistor, .1 %, 2 Termination, 0207,
Taped & Reeled, 1 W, ± 15 ppm/ $^{\circ}\text{C}$, Metal Electrode Leadless Face
(MELF), Neohm SMA-A

[View on TE.com >](#)



Passive Components > Resistors > Surface Mount Resistors



Resistor Type: **Precision Resistor**

Number of Terminations: **2**

Package Size Code: **0207**

Packaging Method: **Taped & Reeled**

Passive Component Tolerance: **.1 %**

Features

Product Type Features

| | |
|-------------------|--------------------|
| Resistor Type | Precision Resistor |
| Package Size Code | 0207 |
| Element Type | Thin Film |

Configuration Features

| | |
|---------------------|---|
| Number of Resistors | 1 |
|---------------------|---|

Electrical Characteristics

| | |
|-----------------------------|-------------------|
| Passive Component Tolerance | .1 % |
| Resistance Class | Up to 1k Ω |
| Resistance Value | 220 Ω |
| Power Rating | 1 W |

Termination Features

| | |
|---|--------------------------------------|
| Number of Terminations | 2 |
| Surface Mount Resistor Termination Type | Metal Electrode Leadless Face (MELF) |

Dimensions

| | |
|------------------|-----------------|
| Product Diameter | 2.2 mm[.087 in] |
| Product Length | 5.9 mm[.232 in] |

Usage Conditions

| | |
|-----------------------------|----------------------------------|
| Operating Temperature Range | -55 – 155 $^{\circ}\text{C}$ |
| Temperature Coefficient | ± 15 ppm/ $^{\circ}\text{C}$ |

Packaging Features

| | |
|------------------|----------------|
| Packaging Method | Taped & Reeled |
|------------------|----------------|

Product Compliance

[For compliance documentation, visit the product page on TE.com>](#)

| | |
|---|---|
| EU RoHS Directive 2011/65/EU | Compliant |
| EU ELV Directive 2000/53/EC | Compliant |
| China RoHS 2 Directive MIIT Order No 32, 2016 | No Restricted Materials Above Threshold |
| EU REACH Regulation (EC) No. 1907/2006 | Current ECHA Candidate List: JUNE 2023 (235) Candidate List Declared Against: JUNE 2023 (235) Does not contain REACH SVHC |
| Halogen Content | Low Halogen - Br, Cl, F, I < 900 ppm per homogenous material. Also BFR/CFR/PVC Free |
| Solder Process Capability | Reflow solder capable to 260 $^{\circ}\text{C}$ |

Product Compliance Disclaimer

This information is provided based on reasonable inquiry of our suppliers and represents our current actual knowledge based on the information they provided. This information is subject to change. The part numbers that TE has identified as EU RoHS compliant have a maximum concentration of 0.1% by weight in homogenous materials for lead, hexavalent chromium, mercury, PBB, PBDE, DBP, BBP, DEHP, DIBP, and 0.01% for cadmium, or qualify for an exemption to these limits as defined in the Annexes of Directive 2011/65/EU (RoHS2). Finished electrical and electronic equipment products will be CE marked as required by Directive 2011/65/EU. Components may not be CE marked. Additionally, the part numbers that TE has identified as EU ELV compliant have a maximum concentration of 0.1% by weight in homogenous materials for lead, hexavalent chromium, and mercury, and 0.01% for cadmium, or qualify for an exemption to these limits as defined in the Annexes of Directive 2000/53/EC (ELV). Regarding the REACH Regulation, the information TE provides on SVHC in articles for this part number is based on the latest European Chemicals Agency (ECHA) 'Guidance on requirements for substances in articles' posted at this URL: <https://echa.europa.eu/guidance-documents/guidance-on-reach>

Compatible Parts

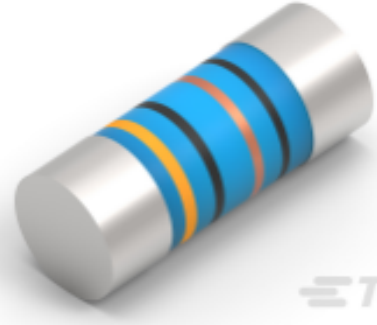
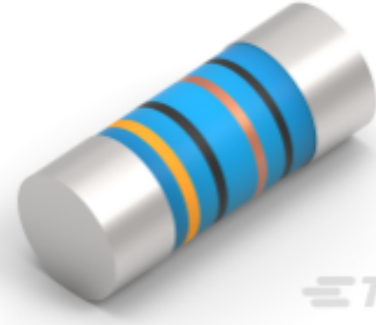
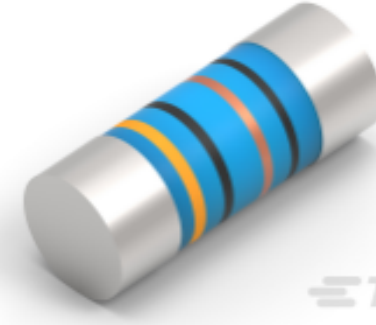
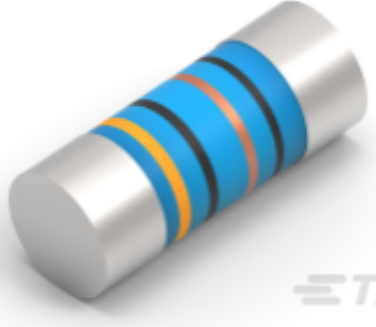
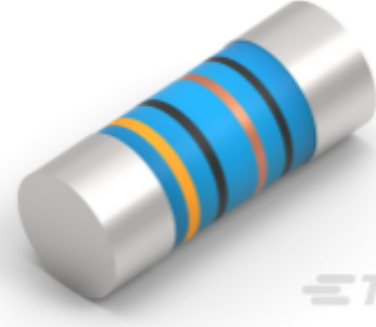
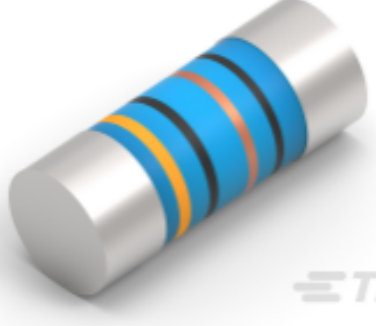
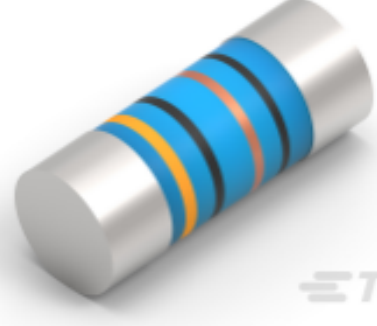
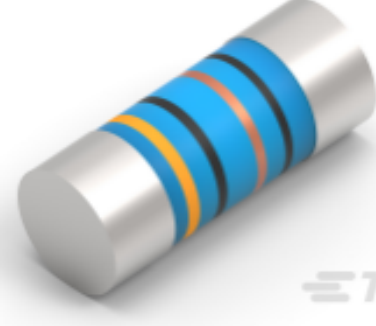
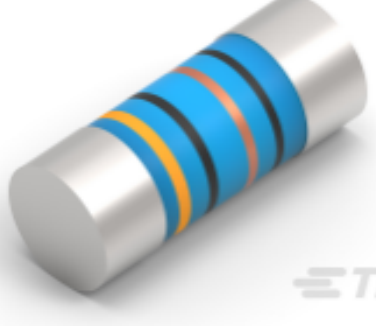
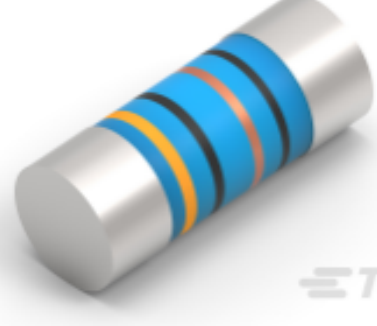
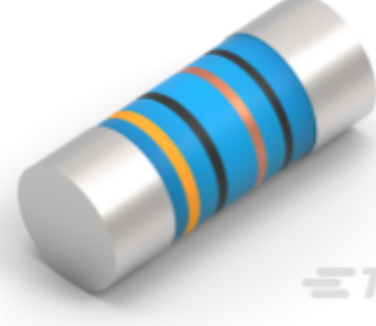
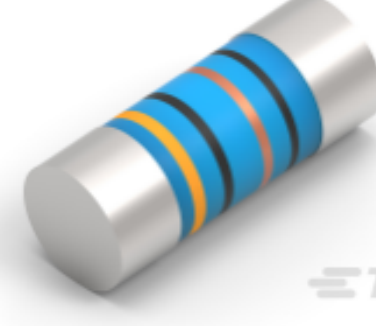
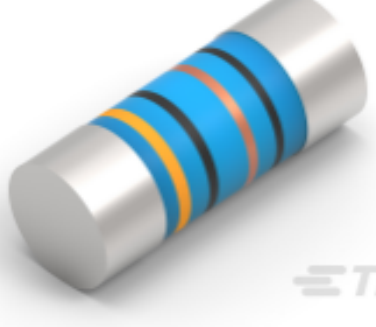
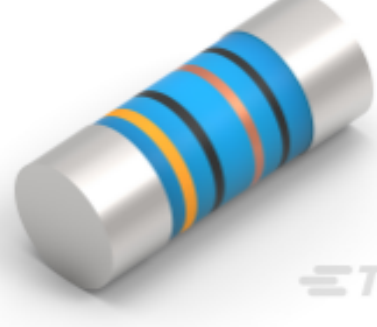
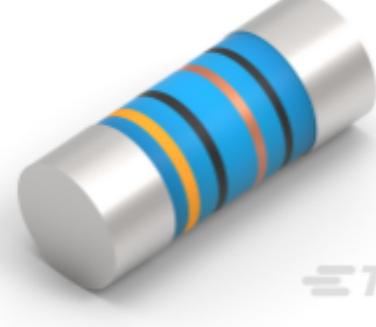
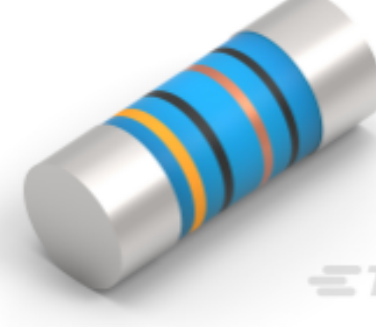

| | | | |
|--|--|--|--|
|  <p>TE Part # 2176314-1 MELF SMA_A 100R 0.1% 15PPM 0102 0.3W</p> |  <p>TE Part # 2-2176314-5 MELF SMA_A 10K 0.1% 15PPM 0102 0.3W</p> |  <p>TE Part # 2176314-2 MELF SMA_A 120R 0.1% 15PPM 0102 0.3W</p> |  <p>TE Part # 2-2176314-6 MELF SMA_A 12K 0.1% 15PPM 0102 0.3W</p> |
|  <p>TE Part # 2176314-3 MELF SMA_A 150R 0.1% 15PPM 0102 0.3W</p> |  <p>TE Part # 2176314-4 MELF SMA_A 180R 0.1% 15PPM 0102 0.3W</p> |  <p>TE Part # 2-2176314-8 MELF SMA_A 18K 0.1% 15PPM 0102 0.3W</p> |  <p>TE Part # 1-2176314-3 MELF SMA_A 1K0 0.1% 15PPM 0102 0.3W</p> |
|  <p>TE Part # 1-2176314-5 MELF SMA_A 1K5 0.1% 15PPM 0102 0.3W</p> |  <p>TE Part # 1-2176314-6 MELF SMA_A 1K8 0.1% 15PPM 0102 0.3W</p> |  <p>TE Part # 2-2176314-9 MELF SMA_A 22K 0.1% 15PPM 0102 0.3W</p> |  <p>TE Part # 2176314-6 MELF SMA_A 270R 0.1% 15PPM 0102 0.3W</p> |
|  <p>TE Part # 1-2176314-7 MELF SMA_A 2K2 0.1% 15PPM 0102 0.3W</p> |  <p>TE Part # 1-2176314-8 MELF SMA_A 2K7 0.1% 15PPM 0102 0.3W</p> |  <p>TE Part # 3-2176314-1 MELF SMA_A 33K 0.1% 15PPM 0102 0.3W</p> |  <p>TE Part # 2176314-8 MELF SMA_A 390R 0.1% 15PPM 0102 0.3W</p> |
|  <p>TE Part # 3-2176314-2 MELF SMA_A 39K 0.1% 15PPM 0102 0.3W</p> |  <p>TE Part # 1-2176314-9 MELF SMA_A 3K3 0.1% 15PPM 0102 0.3W</p> |  <p>TE Part # 2176314-9 MELF SMA_A 470R 0.1% 15PPM 0102 0.3W</p> |  <p>TE Part # 3-2176314-3 MELF SMA_A 47K 0.1% 15PPM 0102 0.3W</p> |

Also in the Series | **Neohm SMA-A**

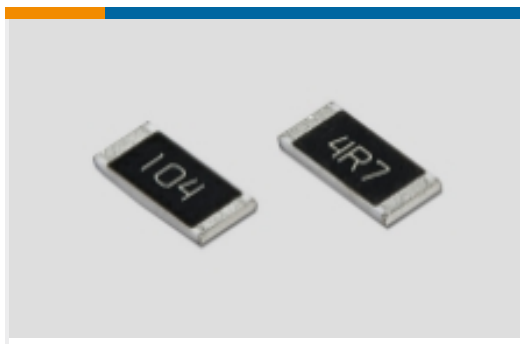

Surface Mount Resistors(384)

Customers Also Bought



TE Part #5553811-1
ASSY,EMI RCPT,24 POSN,SCR LK

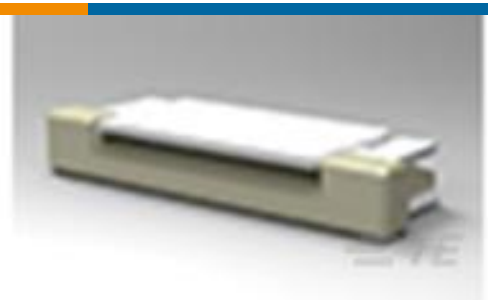

TE Part #4-1734839-0
FPC CONN. 0.5MM PITCH T/C,40P



TE Part #4-2176055-2
RLP73K 2B R51 1% 1K RL



TE Part #5-1618388-5
LEV200H5ANA=RELAY, SPST-NO

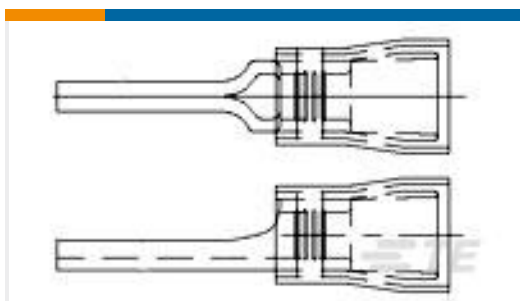

TE Part #165085-1
PG WIRE PIN YELLOW

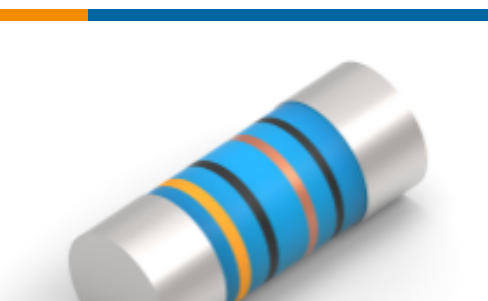

TE Part #1-2176316-3
MELF SMA_A 1K0 0.1% 15PPM 0207 1W



TE Part #1462051-4
HF356=50OHM140MW12V MONO



TE Part #1969688-2
PTL 1X2 PCB HEADER VERT STDTMP KEY A NAT



TE Part #RXM-GPS-FM-T
Module FM L1 GPS RX RCVR T&R

Documents

Product Drawings

[MELF SMA_A 220R 0.1% 15PPM 0207 1W](#)

English

CAD Files

[3D PDF](#)

[3D](#)

[Customer View Model](#)

[ENG_CVM_CVM_2176316-5_BA.2d_dxf.zip](#)



English

Customer View Model

[ENG_CVM_CVM_2176316-5_BA.3d_igs.zip](#)

English

Customer View Model

[ENG_CVM_CVM_2176316-5_BA.3d_stp.zip](#)

English

By downloading the CAD file I accept and agree to the [Terms and Conditions](#) of use.

Datasheets & Catalog Pages

[SMA-A-1017](#)

English