

# BAS19W, BAS20W, BAS21W/AW/CW/SW

## Silicon Epitaxial Planar Diodes

High Voltage Switching Diodes

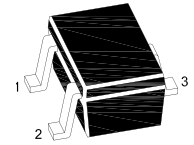

SOT-323 Plastic Package

BAS19W  
BAS20W  
BAS21W

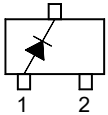

BAS21AW

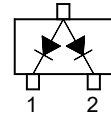

BAS21CW

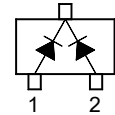

BAS21SW

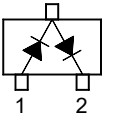

### Absolute Maximum Ratings ( $T_a = 25^\circ\text{C}$ )

Parameter	Symbol	Value	Unit	
Reverse Voltage	$V_R$	BAS19W BAS20W BAS21W/AW/CW/SW	120 200 250	V
Continuous Forward Current		$I_{F(AV)}$	200	mA
Repetitive Peak Forward Current		$I_{FRM}$	625	mA
Non-repetitive Peak Forward Surge Current	$I_{FSM}$	at $t = 1 \text{ s}$	0.5	A
		at $t = 1 \mu\text{s}$	2.5	
Total Device Dissipation	$P_{tot}$	250	mW	
Junction and Storage Temperature Range	$T_j, T_{stg}$	- 55 to + 150	$^\circ\text{C}$	

### Thermal Characteristics

Parameter	Symbol	Max.	Unit
Thermal Resistance, Junction to Ambient <sup>1)</sup>	$R_{\theta JA}$	500	$^\circ\text{C}/\text{W}$

<sup>1)</sup> Device mounted on FR-4 substrate PC board, 2oz copper, with minimum recommended pad layout.

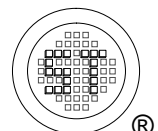

# BAS19W, BAS20W, BAS21W/AW/CW/SW

## Characteristics at $T_a = 25^\circ\text{C}$

Parameter	Symbol	Min.	Max.	Unit
Reverse Breakdown Voltage at $I_R = 100 \mu\text{A}$ at $I_R = 100 \mu\text{A}$ at $I_R = 100 \mu\text{A}$	BAS19W BAS20W BAS21W/AW/CW/SW  $V_{(BR)R}$	120 200 250	- - -	V
Forward Voltage at $I_F = 100 \text{ mA}$ at $I_F = 200 \text{ mA}$	$V_F$	- -	1 1.25	V
Reverse Current at $V_R = 100 \text{ V}$ at $V_R = 150 \text{ V}$ at $V_R = 200 \text{ V}$ at $V_R = 100 \text{ V}, T_j = 150^\circ\text{C}$ at $V_R = 150 \text{ V}, T_j = 150^\circ\text{C}$ at $V_R = 200 \text{ V}, T_j = 150^\circ\text{C}$	BAS19W BAS20W BAS21W/AW/CW/SW BAS19W BAS20W BAS21W/AW/CW/SW  $I_R$	- - - - - -	0.1 0.1 0.1 100 100 100	$\mu\text{A}$
Total Capacitance at $V_R = 0, f = 1 \text{ MHz}$	$C_{tot}$	-	5	pF
Reverse Recovery Time at $I_F = I_R = 30 \text{ mA}, R_L = 100 \Omega, I_{rr} = 0.1 \times I_R$	$t_{rr}$	-	50	ns

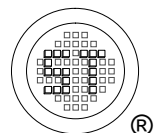

# BAS19W, BAS20W, BAS21W/AW/CW/SW

## Electrical characteristic curve

Fig 1. Power Derating Curve

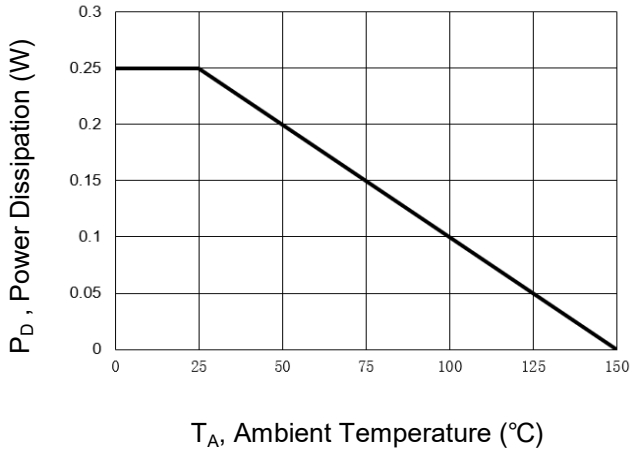

Fig 2. Forward Characteristic Curve

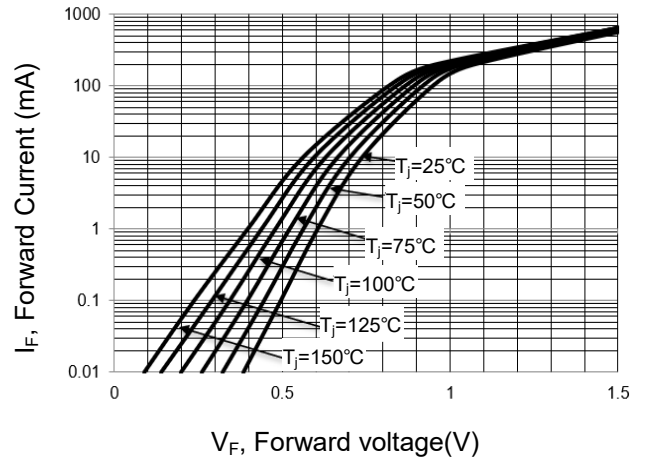

Fig 3. Reverse Characteristic Curve

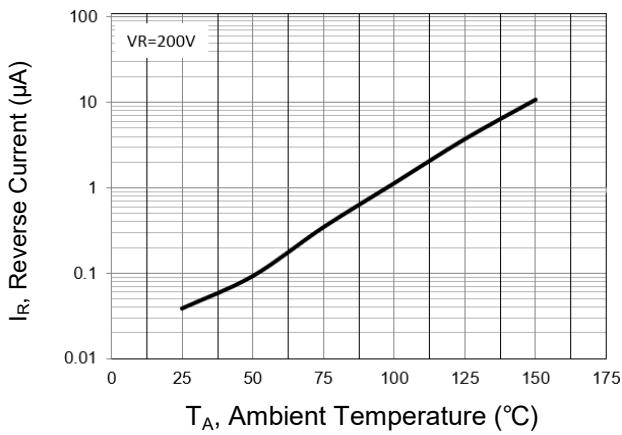
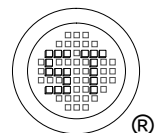
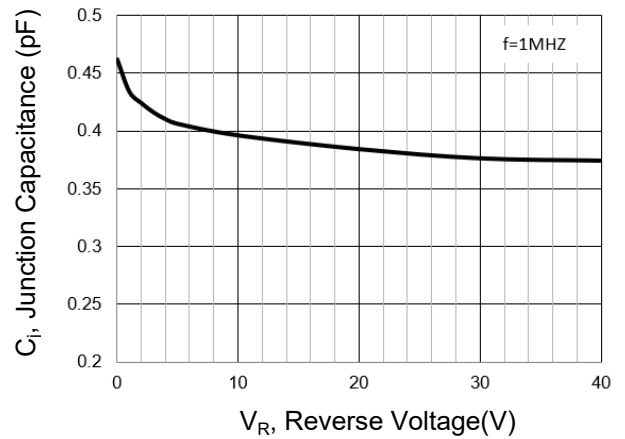

Fig 4. Junction Capacitance



# BAS19W, BAS20W, BAS21W/AW/CW/SW

Package Outline Dimensions (Units: mm)

SOT-323

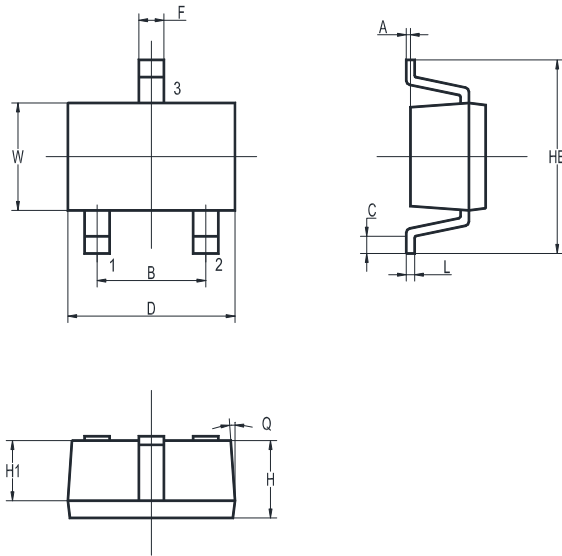

UNIT	A	B	C	D	H	H1	HE	F	L	W	Q
mm	0.1 MAX.	1.4 1.2	0.2 MIN.	2.1 1.9	1.0 0.8	0.7 TYP.	2.4 2.0	0.35 0.25	0.15 0.05	1.35 1.15	5° MAX.

## Recommended Soldering Footprint

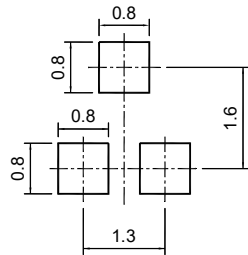

## Packing information

Package	Tape Width (mm)	Pitch		Reel Size		Per Reel Packing Quantity
		mm	inch	mm	inch	
SOT-323	8	4 ± 0.1	0.157 ± 0.004	178	7	3,000

## Marking information

" \*\* " = Part No.

Type	Marking	Type	Marking
BAS19W~BAS21W	F5	BAS21CW	F3
BAS21AW	F2	BAS21SW	F4

" YM " = Date Code Marking

" Y " = Year

" M " = Month

Font type: Arial

