



## WGD13005

### Features

- Wide Safe Operating Area
- Built-in Free Wheeling diode
- Suitable for Electronic Ballast Application
- Small Variance in Storage Time

TO-220

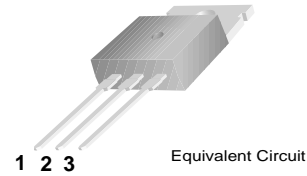

1.Base 2.Collector 3.Emitter

### Absolute Maximum Ratings\* T<sub>c</sub> = 25°C unless otherwise noted

| Symbol           | Parameter                                     | Value     | Units |
|------------------|---|-----------|-------|
| V <sub>CBO</sub> | Collector-Base Voltage                        | 700       | V     |
| V <sub>CEO</sub> | Collector-Emitter Voltage                     | 400       | V     |
| V <sub>EBO</sub> | Emitter-Base Voltage                          | 9         | V     |
| I <sub>C</sub>   | Collector Current (DC)                        | 4         | A     |
| I <sub>CP</sub>  | Collector Current (Pulse)                     | 8         | A     |
| I <sub>B</sub>   | Base Current                                  | 2         | A     |
| P <sub>C</sub>   | Collector Dissipation (T <sub>C</sub> = 25°C) | 70        | W     |
| T <sub>J</sub>   | Junction Temperature                          | 150       | °C    |
| T <sub>STG</sub> | Storage Temperature                           | -65 ~ 150 | °C    |

### Electrical Characteristics T<sub>C</sub> = 25°C unless otherwise noted

| Symbol               | Parameter                            | Test Condition   | Min.    | Typ. | Max.              | Units |
|----------------------|--------------------------------------|--|---------|------|-------------------|-------|
| BV <sub>CBO</sub>    | Collector-Base Breakdown Voltage     | I <sub>C</sub> = 1mA, I <sub>E</sub> = 0   | 700     |      |                   | V     |
| BV <sub>CEO</sub>    | Collector-Emitter Breakdown Voltage  | I <sub>C</sub> = 5mA, I <sub>B</sub> = 0   | 400     |      |                   | V     |
| BV <sub>EBO</sub>    | Emitter-Base Breakdown Voltage       | I <sub>E</sub> = 1mA, I <sub>C</sub> = 0   | 9       |      |                   | V     |
| I <sub>CES</sub>     | Collector Cut-off Current            | V <sub>CE</sub> = 700V, V <sub>EB</sub> = 0  |         |      | 100               | mA    |
| I <sub>CEO</sub>     | Collector Cut-off Current            | V <sub>CE</sub> = 400V, I <sub>B</sub> = 0   |         |      | 250               | mA    |
| I <sub>EBO</sub>     | Emitter Cut-off Current              | V <sub>EB</sub> = 12V, I <sub>C</sub> = 0  |         |      | 100               | mA    |
| h <sub>FE</sub>      | DC Current Gain                      | V <sub>CE</sub> = 5V, I <sub>C</sub> = 10mA<br>V <sub>CE</sub> = 5V, I <sub>C</sub> = 2A   | 10<br>8 |      | 40                |       |
| V <sub>CE(sat)</sub> | Collector-Emitter Saturation Voltage | I <sub>C</sub> = 0.5A, I <sub>B</sub> = 0.1A<br>I <sub>C</sub> = 1A, I <sub>B</sub> = 0.2A<br>I <sub>C</sub> = 2.5A, I <sub>B</sub> = 0.5A |         |      | 0.7<br>1.0<br>1.5 | V     |
| V <sub>BE(sat)</sub> | Base-Emitter Saturation Voltage      | I <sub>C</sub> = 0.5A, I <sub>B</sub> = 0.1A<br>I <sub>C</sub> = 1A, I <sub>B</sub> = 0.2A<br>I <sub>C</sub> = 2.5A, I <sub>B</sub> = 0.5A |         |      | 1.1<br>1.2<br>1.3 | V     |
| V <sub>f</sub>       | Internal Diode Forward Voltage Drop  | I <sub>F</sub> = 2A  |         |      | 2.5               | V     |

\* Pulse Test: PW ≤ 300μs, Duty Cycle ≤ 2%

### Thermal Characteristics

| Symbol           | Parameter                               | Max. | Units |
|------------------|---|------|-------|
| R <sub>θJC</sub> | Thermal Resistance, Junction to Case    | 1.78 | °C/W  |
| R <sub>θJA</sub> | Thermal Resistance, Junction to Ambient | 62.5 | °C/W  |

Typical Performance Characteristics

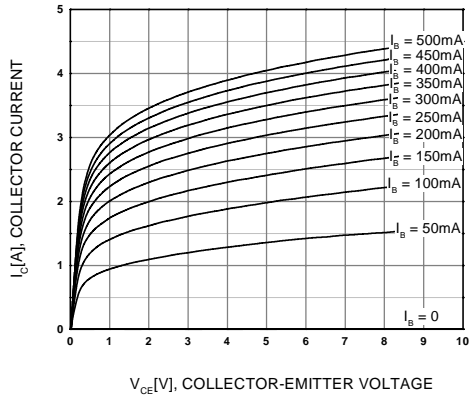

Figure 1. Static Characteristic

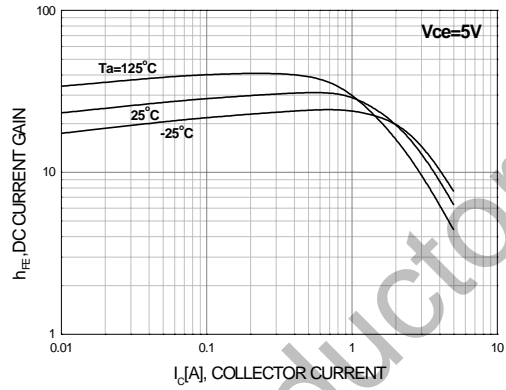

Figure 2. DC Current Gain

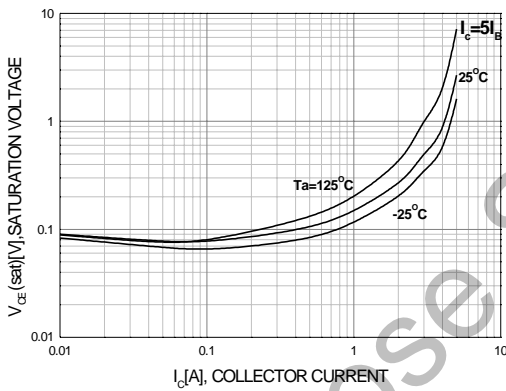

Figure 3. Collector-Emitter Saturation Voltage

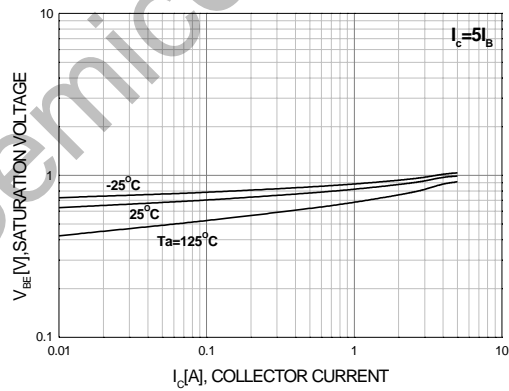

Figure 4. Base-Emitter Saturation Voltage

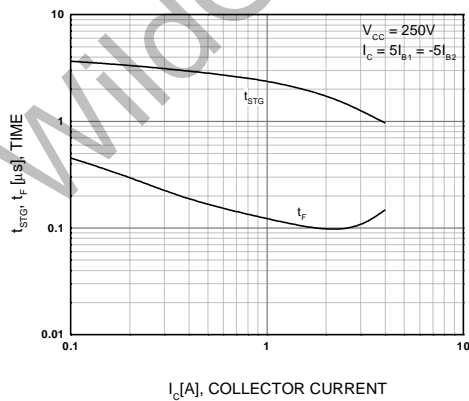

Figure 5. Resistive Load Switching Time

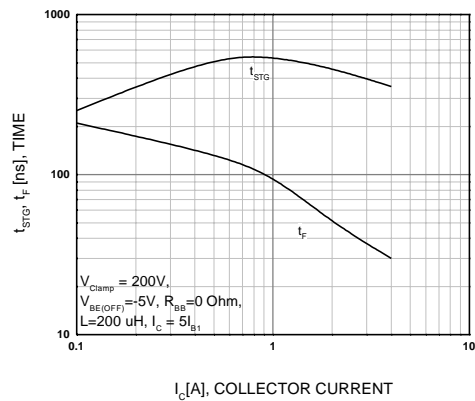

Figure 6. Inductive Load Switching Time

Typical Performance Characteristics

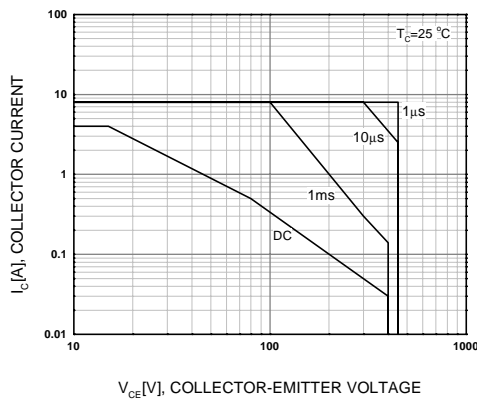

Figure 7. Forward Bias Safe Operating Area

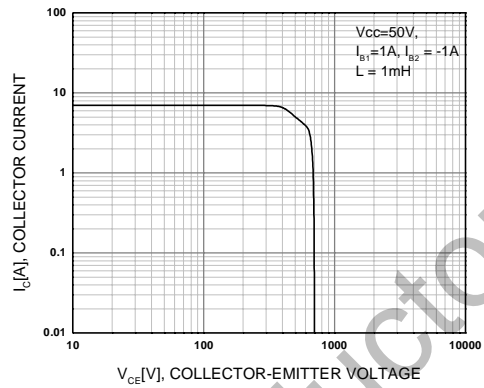

Figure 8. Reverse Bias Safe Operating Area

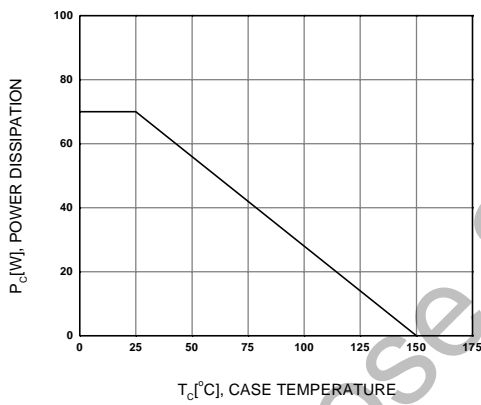
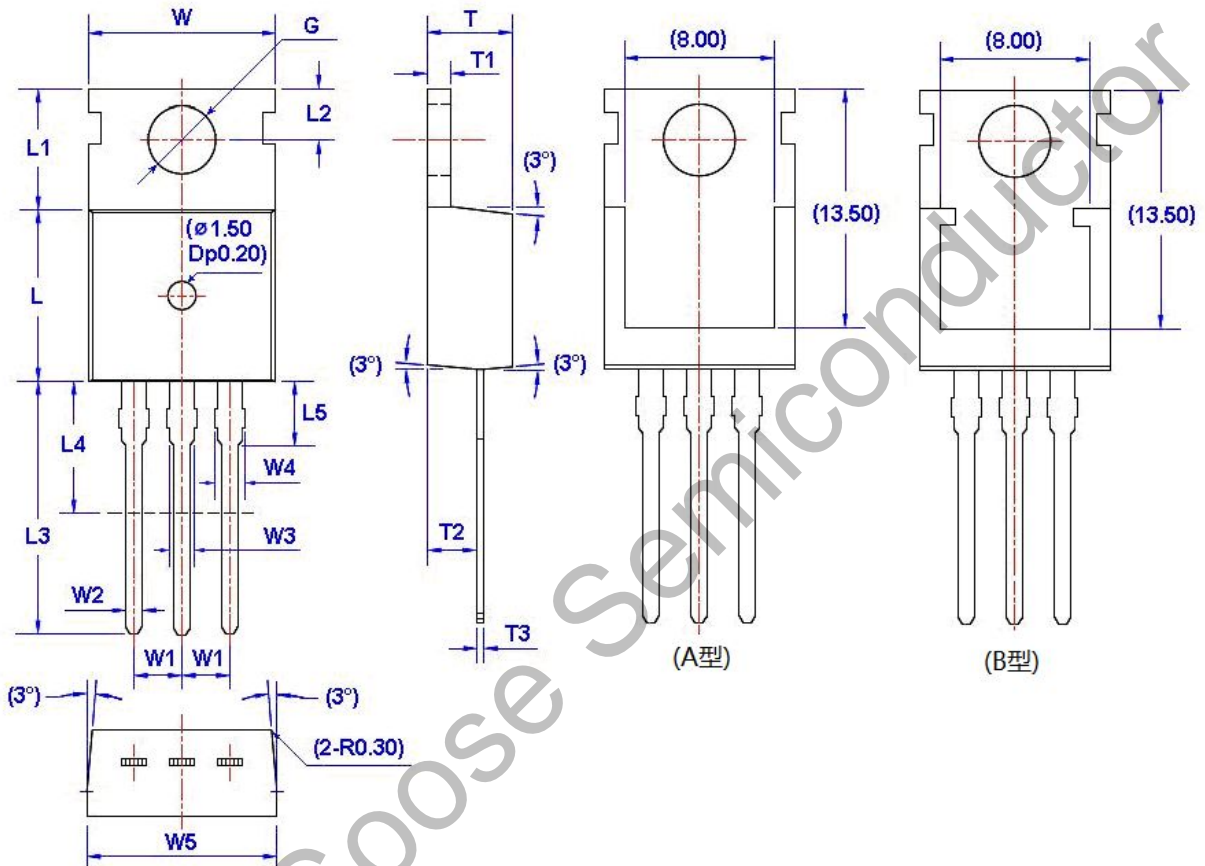

Figure 9. Power Derating

Package Dimension

TO-220

Unit:mm



| Symbol | Size       |       | Symbol | Size  |       | Symbol | Size |      | Symbol                    | Size |      |
|--------|------------|-------|--------|-------|-------|--------|------|------|---------------------------|------|------|
|        | Min        | Max   |        | Min   | Max   |        | Min  | Max  |                           | Min  | Max  |
| W      | 9.66       | 10.28 | W5     | 9.80  | 10.20 | L4**   | 6.20 | 6.60 | T3                        | 0.45 | 0.60 |
| W1     | 2.54 (TYP) |       | L      | 9.00  | 9.40  | L5     | 2.79 | 3.30 | G(Φ)                      | 3.50 | 3.70 |
| W2     | 0.70       | 0.95  | L1     | 6.40  | 6.80  | T      | 4.30 | 4.70 | Dimensions in Millimeters |      |      |
| W3     | 1.17       | 1.37  | L2     | 2.70  | 2.90  | T1     | 1.15 | 1.40 |                           |      |      |
| W4*    | 1.32       | 1.72  | L3     | 12.70 | 14.27 | T2     | 2.20 | 2.60 |                           |      |      |