

技术特性/Specifications:

额定电压 Rated voltage: 100V AC, DC
额定电流 Rated current: 3A AC, DC
接触电阻 Contact resistance: 20m Ω max
绝缘电阻 Insulation resistance: 1000M Ω min
耐压 Withstand voltage: 1000V AC/minute
环境温度 Ambient temperature: -40 $^{\circ}$ C~+105 $^{\circ}$ C
适用线规 Wire range: AWG#26~#22

REV.	REVISION DESCRIPTION	DATE	APPD
B	外形尺寸作调整	22.7.4	Wuhui

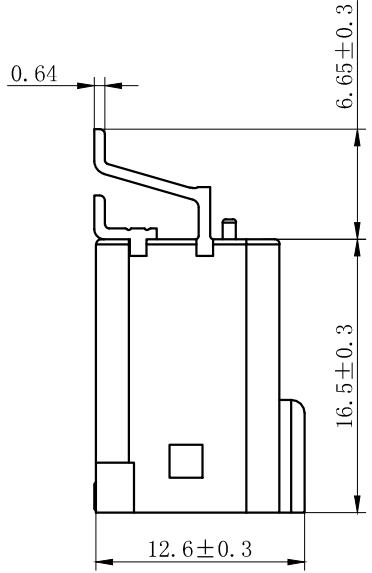
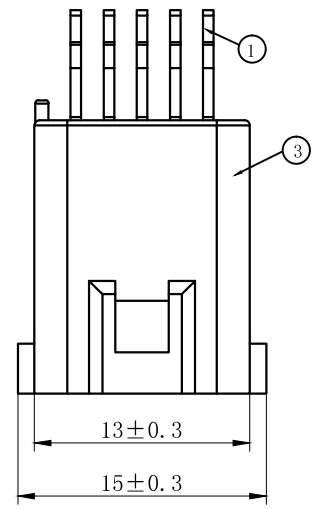
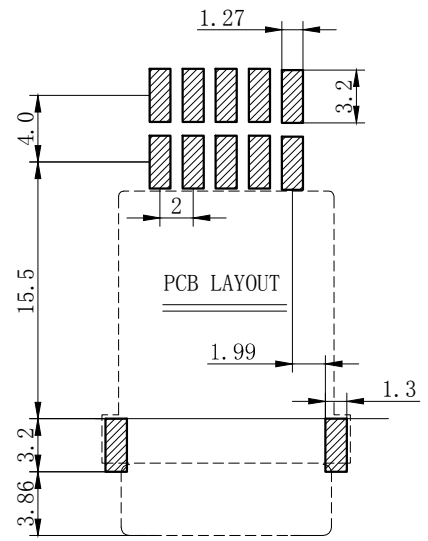
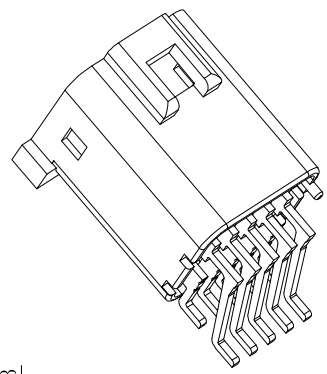
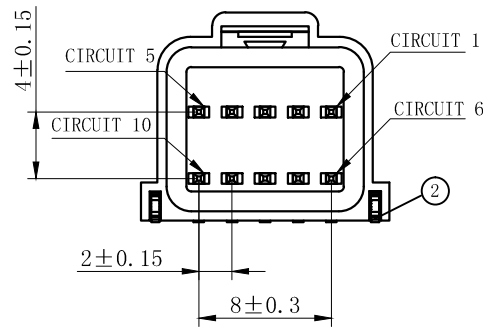

NOTES

Available in 10 Circuits.
 Mates with DL20023-Y Series Housing.
 Material : LCP UL94V-0.
 Pin Material : Brass.Tin-plated .
 Green Material RoHS Compliant.

序号	图号	名称	材料	数量	附件
3	③	基座	LCP	1	UL94V-0
2	②	焊片	黄铜	2	镀锡
1	①	接触件	黄铜	N*	镀锡

GENERAL TOLERANCES (UNLESS SPECIFIED)		ZHE JIANG DELI CONNECTORS CO ., LTD	
.X: ± 0.30	X° : ± 3.0°	PRODUCT NAME: DL20023-10AWB	
.XX: ± 0.15	.X° : ± 2.0°	TITLE: 2.00 mm Pitch Wire To Board SMT Wafer	
.XXX: ± 0.01	.XX° : ± 1.0°	DR:Chen Quan Long	DATE:22.05.19
FINISH: _____		CHKD: Wu Hui	DATE:22.05.19
DRAWING NO: GC-DL20023-XXWB-XXX-XX-X-XX		APPD: Ren An De	DATE:22.05.19
		SCALE: N/A	PAGE:1/1
		UNITS: mm	REV. : B

REV.	REVISION DESCRIPTION	DATE	APPD
------	----------------------	------	------

DL20023-2AS

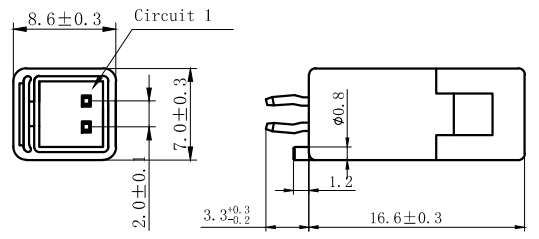

DL20023-6AS

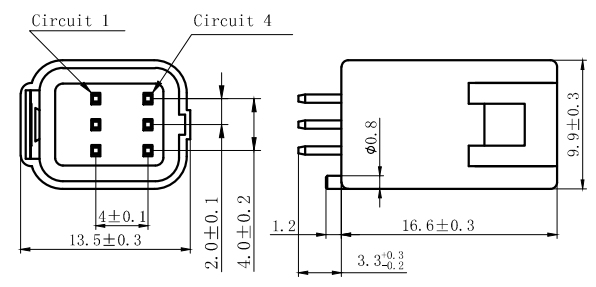

DL20023-3AS

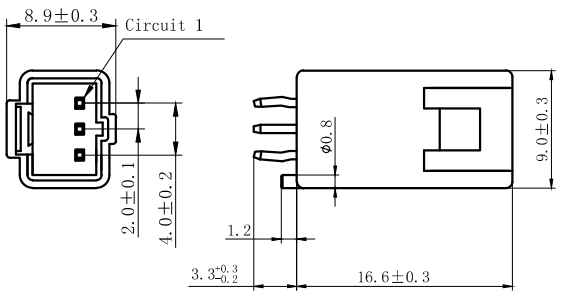

DL20023-8AS

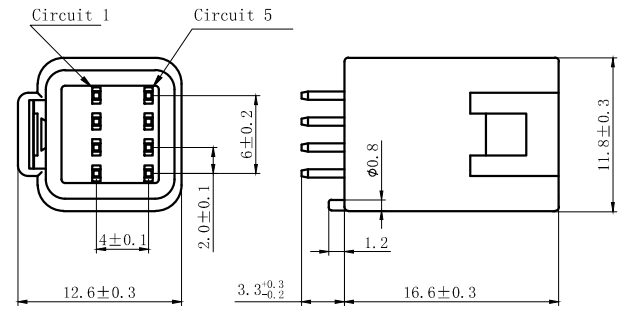

DL20023-4AS

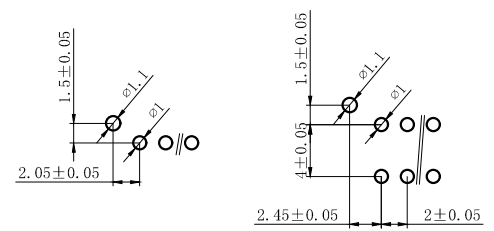
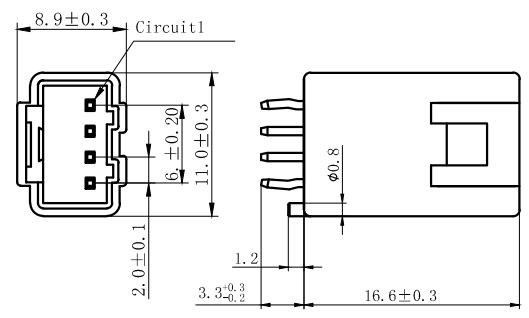

P. C. B LATOUT

NORES:

1. Rated voltage: 100V AC/DC
2. Rated current: 3A AC/DC
3. Contact resistance: $\leq 15 \text{ m}\Omega$
4. Insulation resistance: $\geq 1000 \text{ M}\Omega$
5. Withstand voltage: 1000V AC/minute
6. Ambient temperature: $-40^\circ\text{C} \sim 105^\circ\text{C}$
7. Materials: PBT UL94V-0(2).
8. Matched RoHS criteria

GENERAL TOLERANCES (UNLESS SPECIFIED)		ZHE JIANG DELI CONNECTORS CO., LTD	
.X: ± 0.30	X°: $\pm 3.0^\circ$	PRODUCT NAME: DL20023-AS	TITLE: 2.0 mm Pitch Wire To Board Wafer
.XX: ± 0.15	.X°: $\pm 2.0^\circ$	DR: Yuan Jun Rong	DATE: 20.10.12
.XXX: ± 0.01	.XX°: $\pm 1.0^\circ$	DATE: 20.10.12	PART NO:
FINISH:		CHKD: Wu Hui	DATE: 20.10.12
DRAWING NO:		APPD: Ren An De	DATE: 20.10.12
		SCALE: N/A	PAGE: 1/2
		UNITS: mm	REV.: A

REV.	REVISION DESCRIPTION	DATE	APPD

DL20023-10AS

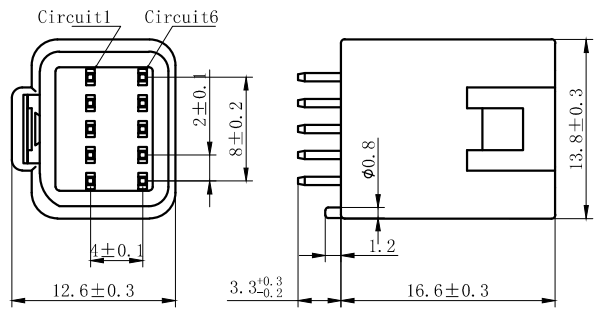

DL20023-12AS

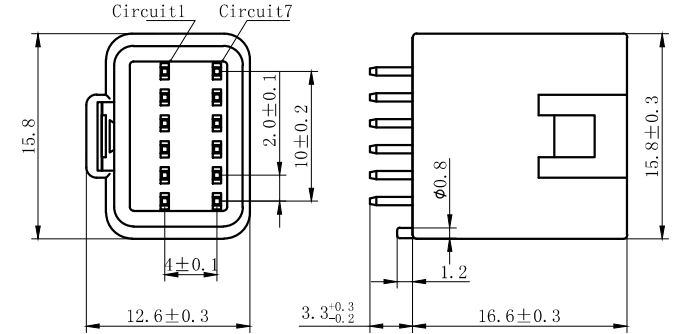

- NORES:
1. Rated voltage: 100V AC/DC
 2. Rated current: 3A AC/DC
 3. Contact resistance: $\leq 15 \text{ m}\Omega$
 4. Insulation resistance: $\geq 1000 \text{ M}\Omega$
 5. Withstand voltage: 1000V AC/minute
 6. Ambient temperature: $-40^\circ\text{C} \sim 105^\circ\text{C}$
 7. Materials: PBT UL94V-0(2).
 8. Matched RoHS criteria

DL20023-14AS

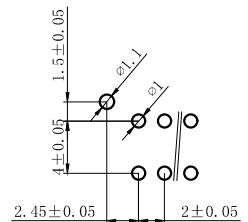
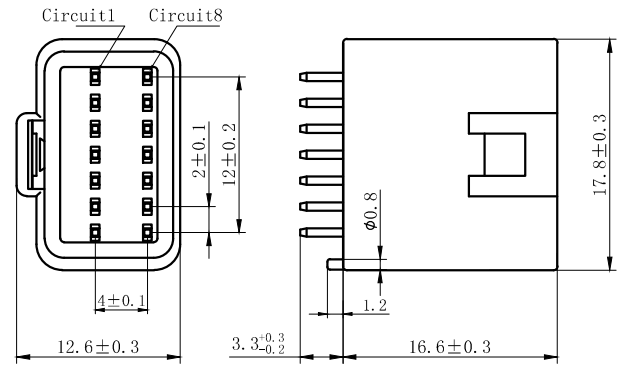

P. C. B LAYOUT

GENERAL TOLERANCES (UNLESS SPECIFIED)		ZHE JIANG DELI CONNECTORS CO., LTD			
.X: ± 0.30	X°: $\pm 3.0^\circ$	PRODUCT NAME: DL20023-AS		TITLE: 2.0 mm Pitch Wire To Board Wafer	
.XX: ± 0.15	.X°: $\pm 2.0^\circ$	DR: Yuan Jun Rong	DATE: 20.10.12	PART NO:	
.XXX: ± 0.01	.XX°: $\pm 1.0^\circ$	CHKD: Wu Hui	DATE: 20.10.12	SCALE: N/A	PAGE: 2/2
DRAWING NO:		APPD: Ren An De	DATE: 20.10.12	UNITS: mm	REV.: A

REV.	REVISION DESCRIPTION	DATE	APPD
------	----------------------	------	------

DL20023-2AWS

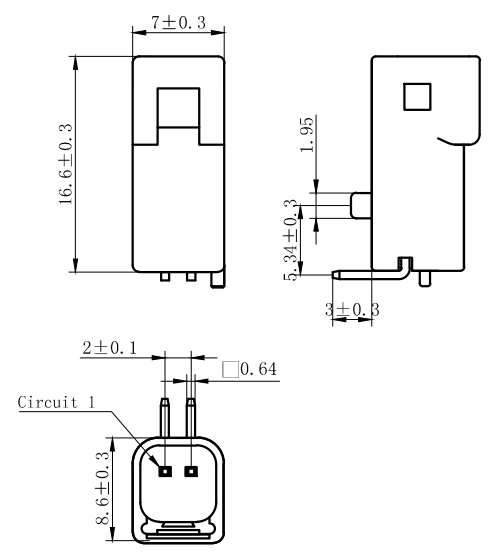

DL20023-3AWS

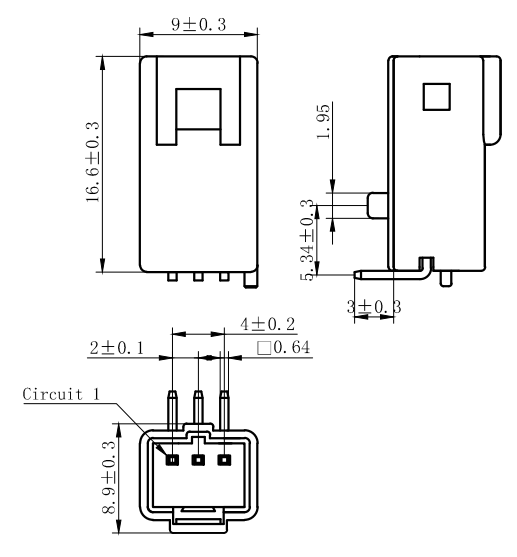

NORES:

1. Rated voltage: 100V AC.DC
2. Rated current: 3A AC DC
3. Contact resistance: ≤ 15 m Ω
4. Insulation resistance: ≥ 1000 M Ω
5. Withstand voltage: 1000V AC/minute
6. Ambient temprature: $-40^{\circ}\text{C} \sim 105^{\circ}\text{C}$
7. Materials: PBT UL94V-0(2).
8. Matched RoHS criteria

DL20023-4AWS

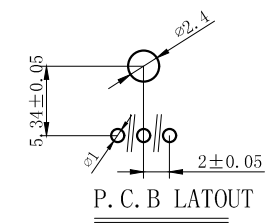
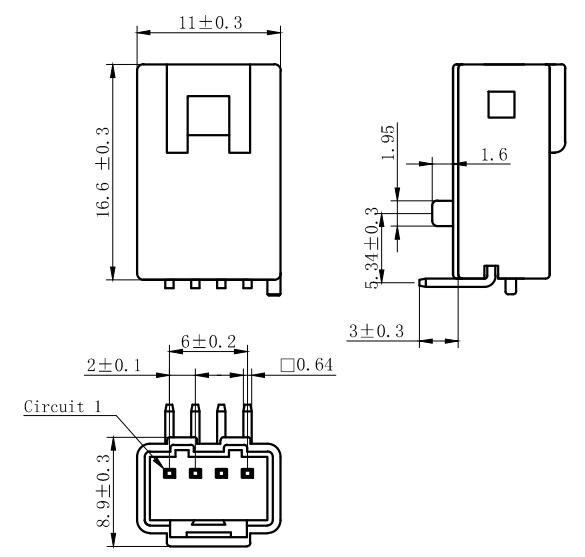

GENERAL TOLERANCES (UNLESS SPECIFIED)		ZHE JIANG DELI CONNECTORS CO., LTD			
.X: ± 0.30	X°: $\pm 3.0^{\circ}$	PRODUCT NAME: DL20023-AWS		TITLE: 2.0 mm Pitch Wire To Board Wafer	
.XX: ± 0.15	.X°: $\pm 2.0^{\circ}$	DR: Yuan Jun Rong	DATE: 20.10.12	PART NO:	
.XXX: ± 0.01	.XX°: $\pm 1.0^{\circ}$	CHKD: Wu Hui	DATE: 20.10.12	SCALE: N/A	PAGE: 1/3
DRAWING NO:		APPD: Ren An De	DATE: 20.10.12	UNITS: mm	REV.: A

DL20023-6AWS

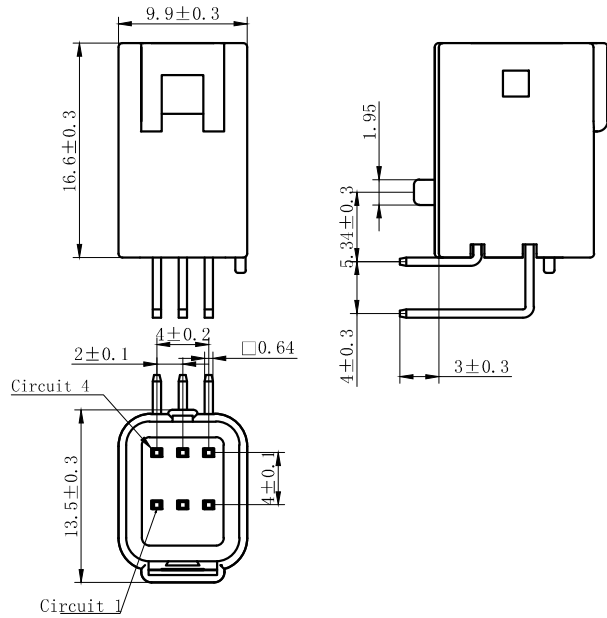

DL20023-8AWS

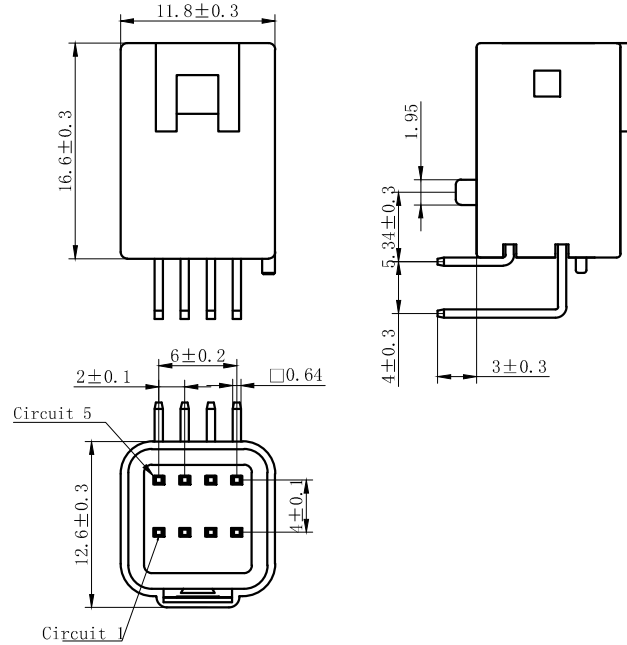

DL20023-10AWS

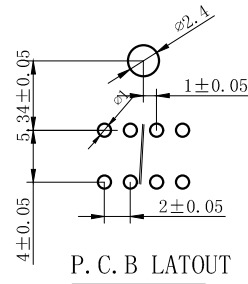
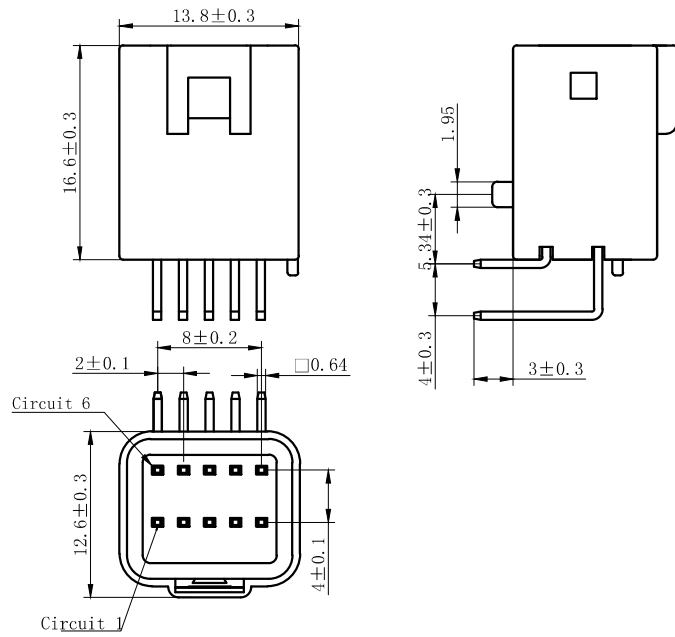

NORES:

1. Rated voltage: 100V AC/DC
2. Rated current: 3A AC/DC
3. Contact resistance: $\leq 15 \text{ m}\Omega$
4. Insulation resistance: $\geq 1000 \text{ M}\Omega$
5. Withstand voltage: 1000V AC/minute
6. Ambient temperature: $-40^\circ\text{C} \sim 105^\circ\text{C}$
7. Materials: PBT UL94V-0(2).
8. Matched RoHS criteria

GENERAL TOLERANCES (UNLESS SPECIFIED)		ZHE JIANG DELI CONNECTORS CO., LTD			
.X: ± 0.30	X°: $\pm 3.0^\circ$	PRODUCT NAME: DL20023-AWS		TITLE: 2.0 mm Pitch Wire To Board Wafer	
.XX: ± 0.15	.X°: $\pm 2.0^\circ$	DR: Yuan Jun Rong	DATE: 20.10.12	PART NO:	
.XXX: ± 0.01	.XX°: $\pm 1.0^\circ$	FINISH:	CHKD: Wu Hui	DATE: 20.10.12	SCALE: N/A
DRAWING NO:		APPD: Ren An De	DATE: 20.10.12	UNITS: mm	PAGE: 2/3
				REV.: A	

REV.	REVISION DESCRIPTION	DATE	APPD

DL20023-12AWS

DL20023-14AWS

NORES:

1. Rated voltage: 100V AC.DC
2. Rated current: 3A AC DC
3. Contact resistance: $\leq 15 \text{ m}\Omega$
4. Insulation resistance: $\geq 1000 \text{ M}\Omega$
5. Withstand voltage: 1000V AC/minute
6. Ambient temperature: $-40^{\circ}\text{C} \sim 105^{\circ}\text{C}$
7. Materials: PBT UL94V-0(2).
8. Matched RoHS criteria

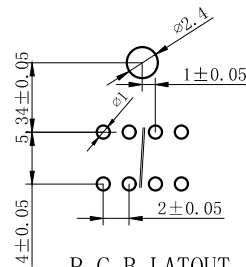
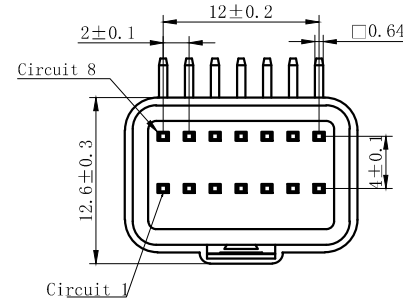
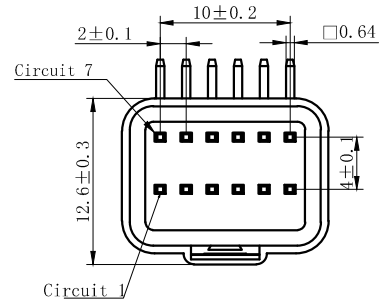
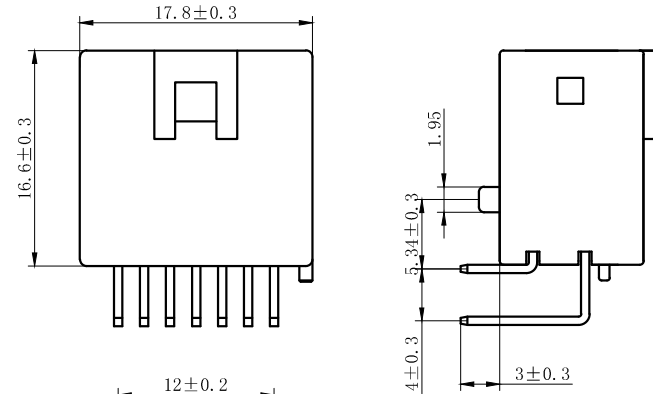
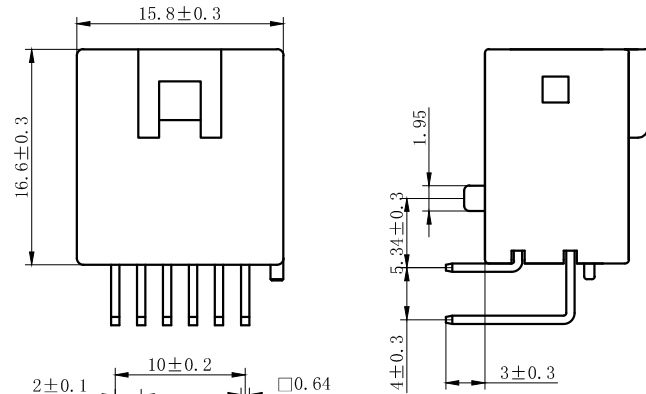

P. C. B LATOUT

GENERAL TOLERANCES (UNLESS SPECIFIED)		ZHE JIANG DELI CONNECTORS CO., LTD	
.X: ± 0.30	X°: ± 3.0°	PRODUCT NAME: DL20023-AWS	TITLE: 2.0 mm Pitch Wire To Board Wafer
.XX: ± 0.15	.X°: ± 2.0°	DR: Yuan Jun Rong	DATE: 20.10.12
.XXX: ± 0.01	.XX°: ± 1.0°	CHKD: Wu Hui	DATE: 20.10.12
DRAWING NO:		APPD: Ren An De	DATE: 20.10.12
		PART NO:	SCALE: N/A
			PAGE: 3/3
		UNITS: mm	REV.: A

DL20023-2Y

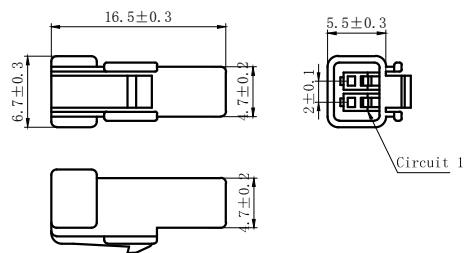

DL20023-3Y

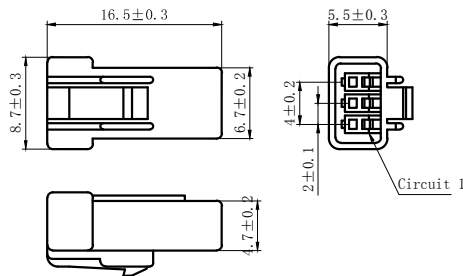

DL20023-8Y

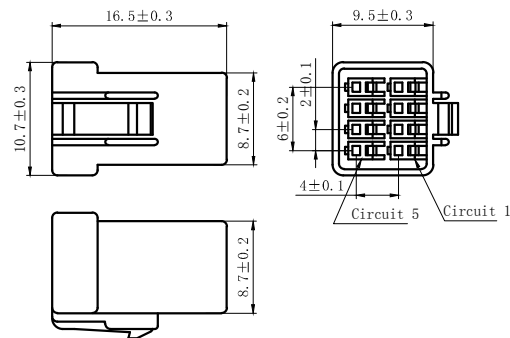

REV.	REVISION DESCRIPTION	DATE	APPD

DL20023-4Y

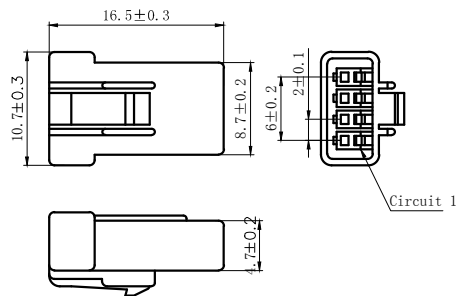

DL20023-6Y

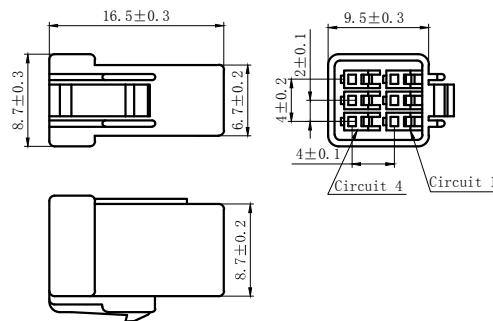

NOTES

Available in 02.03.04.06.08 Circuits.
 Mates with DL20023 Series Housing.
 Material : PBT UL94V-0(2).
 Accepts DL20023-T Crimp Terminal.
 Green Material RoHS Compliant.

GENERAL TOLERANCES (UNLESS SPECIFIED)		ZHE JIANG DELI CONNECTORS CO.,LTD	
. X: ± 0.30	X° ± 3.0°	PRODUCT NAME: DL20023-Y	TITLE: 2.0 mm Pitch Housing
. XX: ± 0.15	. X° ± 2.0°	DR:Chen Quan Long	DATE:21/08/01
. XXX: ± 0.01	. X° ± 1.0°	CHKD:Wu Hui	DATE:21/08/01
FINISH:		APPD:Ren An De	DATE:21/08/01
DRAWING NO:			

PART NO:	
SCALE: N/A	PAGE:1/2
UNITS: mm	REV.: A

REV.	REVISION DESCRIPTION	DATE	APPD

DL20023-10Y

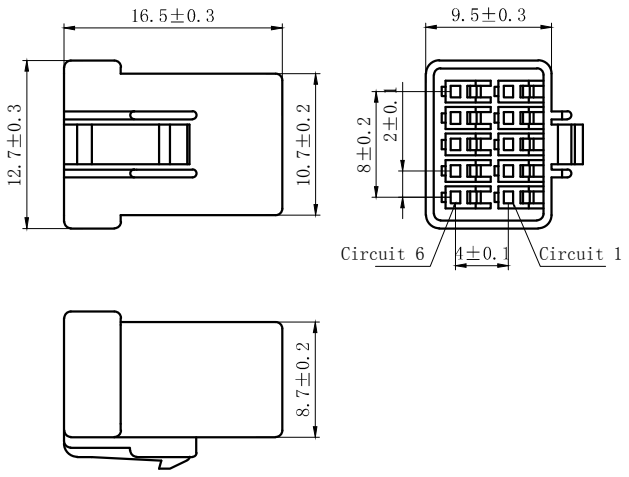

DL20023-12Y

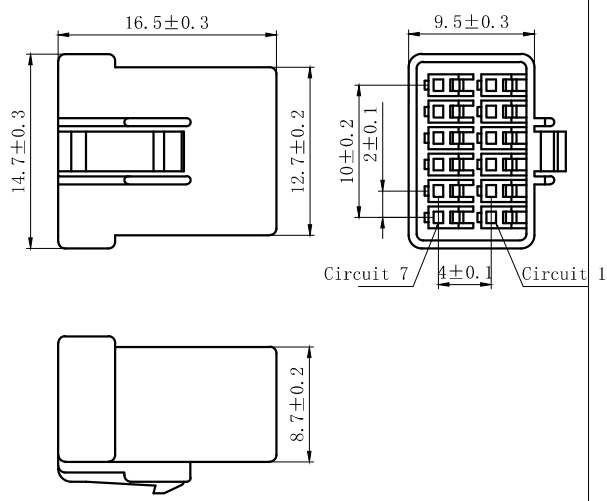

DL20023-14Y

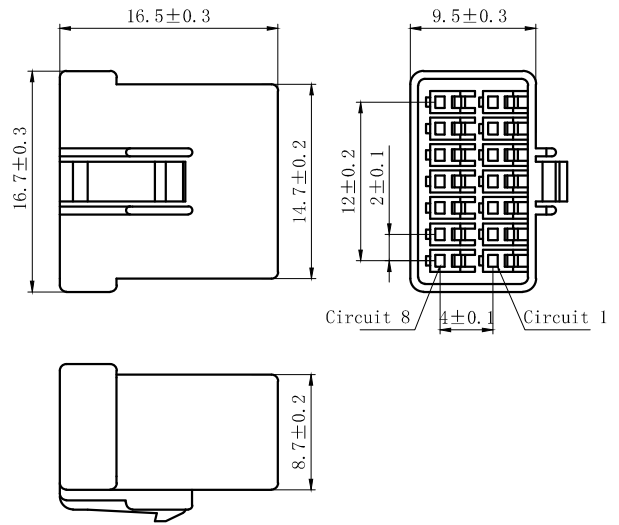

NOTES

Available in 10.12.14 Circuits.
 Mates with DL20023 Series Housing.
 Material : PBT UL94V-0(2).
 Accepts DL20023-T Crimp Terminal.
 Green Material RoHS Compliant.

GENERAL TOLERANCES (UNLESS SPECIFIED)		ZHE JIANG DELI CONNECTORS CO., LTD	
.X: ± 0.30	X° ± 3.0°	PRODUCT NAME: DL20023-Y	TITLE: 2.0 mm Pitch Housing
.XX: ± 0.15	.X° ± 2.0°	DR:Chen Quan Long	DATE:21/08/01
.XXX: ± 0.01	.X° ± 1.0°	CHKD:Wu Hui	DATE:21/08/01
FINISH:		APPD:Ren An De	DATE:21/08/01
DRAWING NO:			

A

B

C

D

E

F

A

B

C

D

E

F

1 2 3 4 5 6 7 8

1 2 3 4 5 6 7 8

DL20023-2Y-0.75

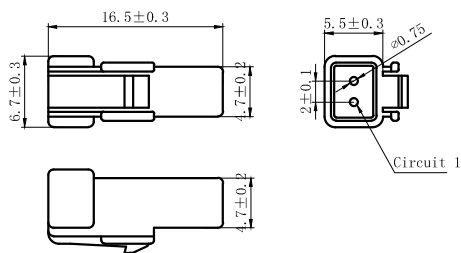

DL20023-3Y-0.75

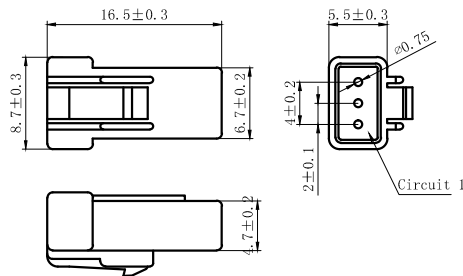

DL20023-8Y-0.75

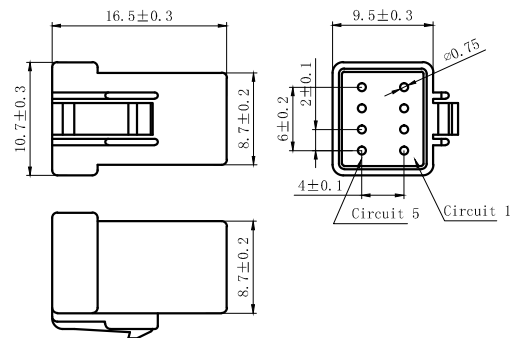

REV.	REVISION DESCRIPTION	DATE	APPD

DL20023-4Y-0.75

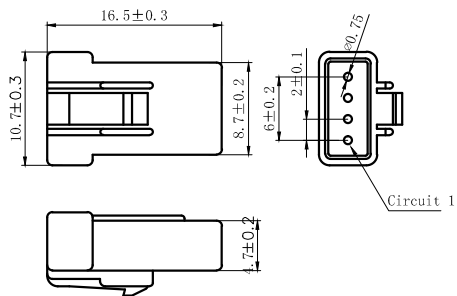

DL20023-6Y-0.75

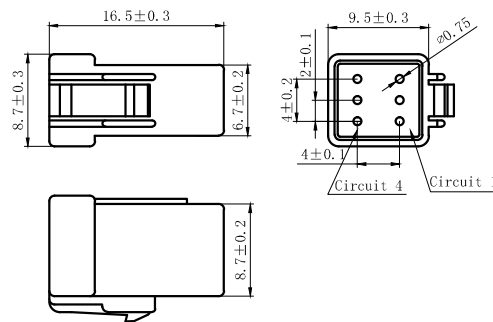

NOTES

Available in 02.03.04.06.08 Circuits.
 Mates with DL20023 Series Housing.
 Material : PBT UL94V-0(2).
 Accepts DL20023-T Crimp Terminal.
 Green Material RoHS Compliant.

GENERAL TOLERANCES (UNLESS SPECIFIED)		ZHE JIANG DELI CONNECTORS CO.,LTD	
.X: ± 0.30	X° ± 3.0°	PRODUCT NAME: DL20023-Y-0.75	TITLE: 2.0 mm Pitch Housing
.XX: ± 0.15	.X° ± 2.0°	DR:Chen Quan Long	DATE:21/08/01
.XXX: ± 0.01	.X° ± 1.0°	CHKD:Wu Hui	DATE:21/08/01
FINISH:		APPD:Ren An De	DATE:21/08/01
DRAWING NO:			

PART NO:	
SCALE: N/A	PAGE:1/2
UNITS: mm	REV.: A

REV.	REVISION DESCRIPTION	DATE	APPD

DL20023-10R-0.75

DL20023-12R-0.75

DL20023-14R-0.75

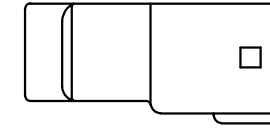
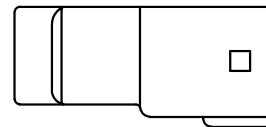
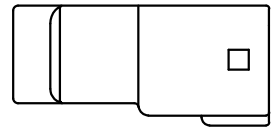
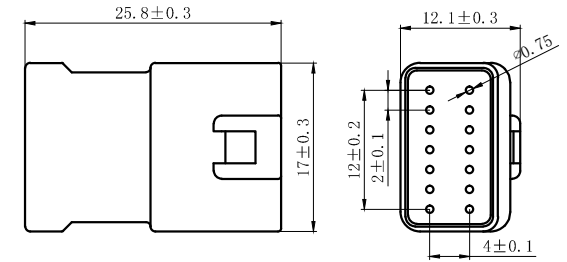
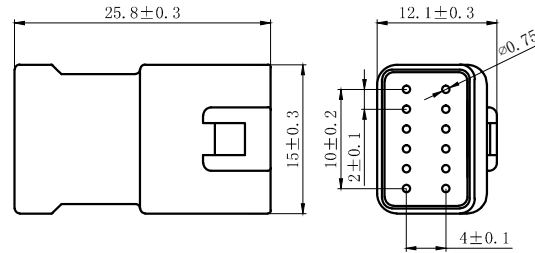
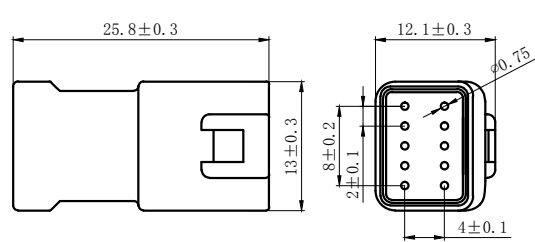

NOTES

Available in 10.12.14 Circuits.

Mates with DL20023-Y Series Housing.

Material : PBT UL94V-0(2).

Accepts DL20023-RT Crimp Terminal.

Green Material RoHS Compliant.

GENERAL TOLERANCES (UNLESS SPECIFIED)		ZHE JIANG DELI CONNECTORS CO., LTD	
.X: ± 0.30	X° : ± 3.0°	PRODUCT NAME: DL20023-R-0.75	TITLE: 2.0 mm Pitch Wire To Wire Receptacle Housing
.XX: ± 0.15	.X° : ± 2.0°	DR:Chen Quan Long	DATE:21/08/01
.XXX: ± 0.01	.XX° : ± 1.0°	DATE:21/08/01	SCALE: N/A
FINISH: _____		CHKD:Wu Hui	DATE:21/08/01
DRAWING NO:		APPD:Ren An De	DATE:21/08/01
		UNITS: mm	PAGE:2/2
			REV. : A

REV.	REVISION DESCRIPTION	DATE	APPD

DL20023-2R

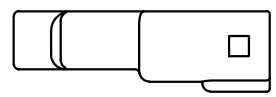
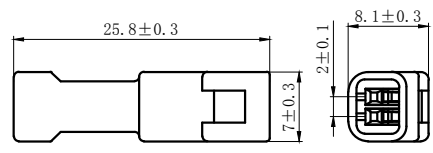

DL20023-3R

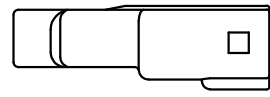
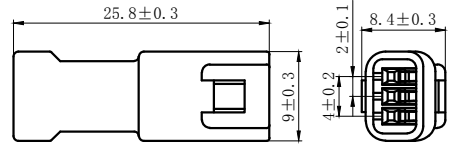

DL20023-8R

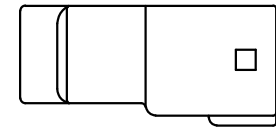
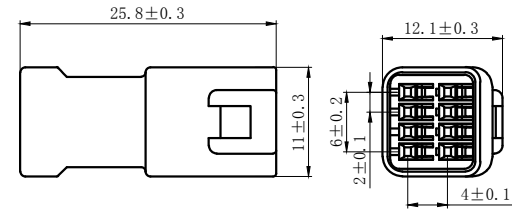

DL20023-4R

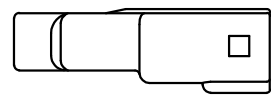
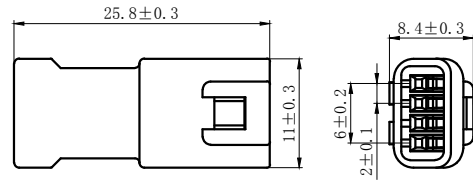

DL20023-6R

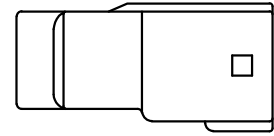
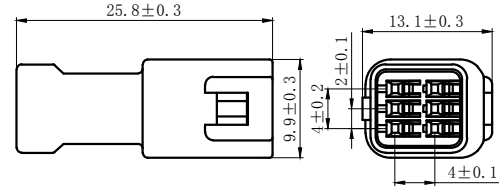

NOTES

Available in 02.03.04.06.08 Circuits.
 Mates with DL20023-Y Series Housing.
 Material : PBT UL94V-0(2).
 Accepts DL20023-RT Crimp Terminal.
 Green Material RoHS Compliant.

GENERAL TOLERANCES (UNLESS SPECIFIED)		ZHE JIANG DELI CONNECTORS CO., LTD	
.X: ± 0.30	X°: ± 3.0°	PRODUCT NAME:	TITLE:
.XX: ± 0.15	.X°: ± 2.0°	DL20023-R	2.0 mm Pitch Wire To Wire Receptacle Housing
.XXX: ± 0.01	.XX°: ± 1.0°	DR:Chen Quan Long	DATE:21/08/01
FINISH:		CHKD:Wu Hui	DATE:21/08/01
DRAWING NO:		APPD:Ren An De	DATE:21/08/01
		SCALE: N/A	PAGE:1/2
		UNITS: mm	REV.: A

REV.	REVISION DESCRIPTION	DATE	APPD

DL20023-10R

DL20023-12R

DL20023-14R

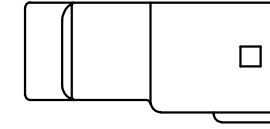
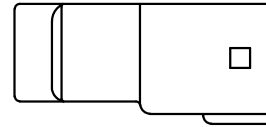
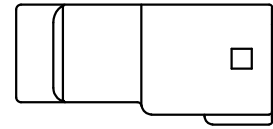
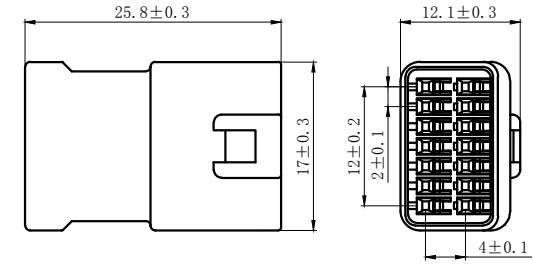
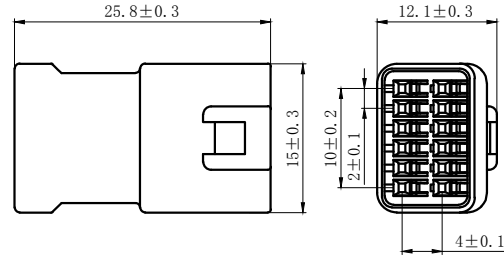
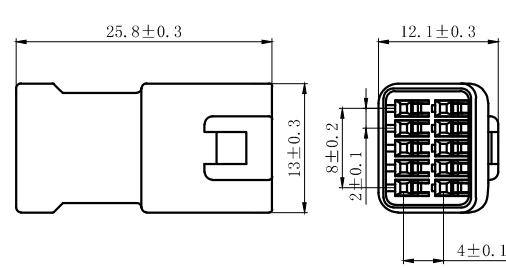

NOTES

- Available in 10.12.14 Circuits.
- Mates with DL20023-Y Series Housing.
- Material : PBT UL94V-0(2).
- Accepts DL20023-RT Crimp Terminal.
- Green Material RoHS Compliant.

GENERAL TOLERANCES (UNLESS SPECIFIED)		ZHE JIANG DELI CONNECTORS CO., LTD	
.X: ± 0.30	X° : ± 3.0°	PRODUCT NAME: DL20023-R	TITLE: 2.0 mm Pitch Wire To Wire Receptacle Housing
.XX: ± 0.15	.X° : ± 2.0°	DR:Chen Quan Long	DATE:21/08/01
.XXX: ± 0.01	.XX° : ± 1.0°	CHKD:Wu Hui	DATE:21/08/01
FINISH: _____		APPD:Ren An De	DATE:21/08/01
DRAWING NO:		UNITS: mm	REV. : A

REV.	REVISION DESCRIPTION	DATE	APPD

DL20023-2R-0.75

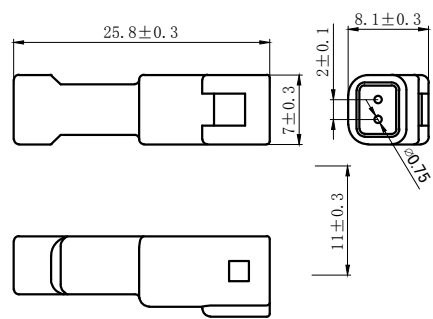

DL20023-3R-0.75

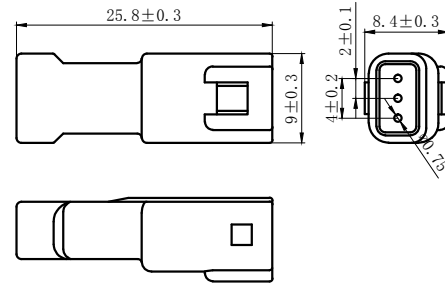

DL20023-8R-0.75

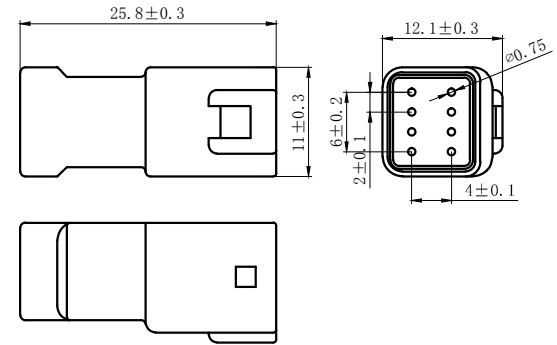

DL20023-4R-0.75

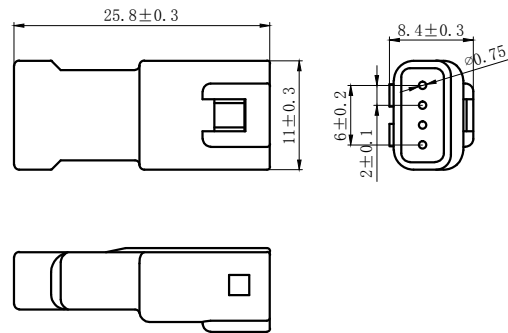

DL20023-6R-0.75

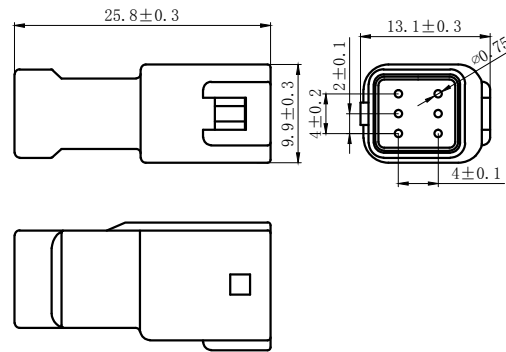

NOTES

Available in 02.03.04.06.08 Circuits.
Mates with DL20023-Y Series Housing.
Material : PBT UL94V-0(2).
Accepts DL20023-RT Crimp Terminal.
Green Material RoHS Compliant.

GENERAL TOLERANCES (UNLESS SPECIFIED)		ZHE JIANG DELI CONNECTORS CO., LTD	
.X: ± 0.30	X° : ± 3.0°	PRODUCT NAME: DL20023-R-0.75	TITLE: 2.0 mm Pitch Wire To Wire Receptacle Housing
.XX: ± 0.15	.X° : ± 2.0°	DR:Chen Quan Long	DATE:21/08/01
.XXX: ± 0.01	.XX° : ± 1.0°	CHKD:Wu Hui	DATE:21/08/01
FINISH:		APPD:Ren An De	DATE:21/08/01
DRAWING NO:		SCALE: N/A	PAGE:1/2
		UNITS: mm	REV.: A

DL20023-10Y-0.75

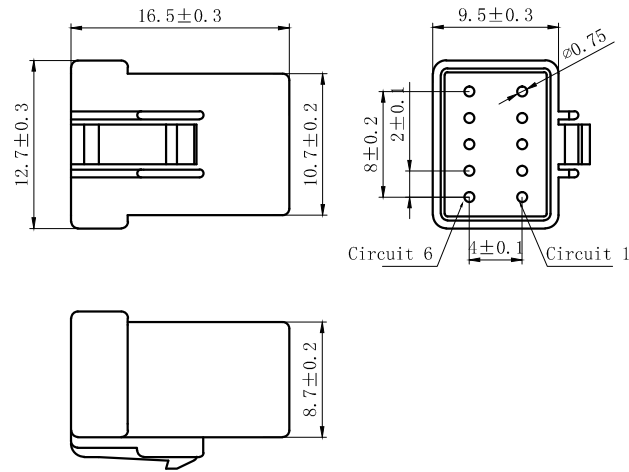

DL20023-12Y-0.75

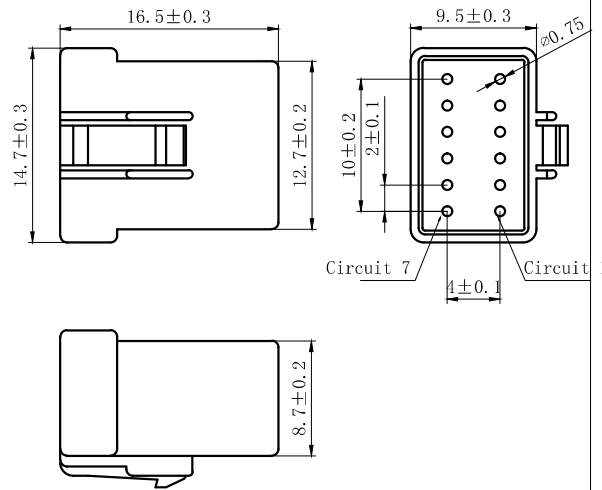

DL20023-14Y-0.75

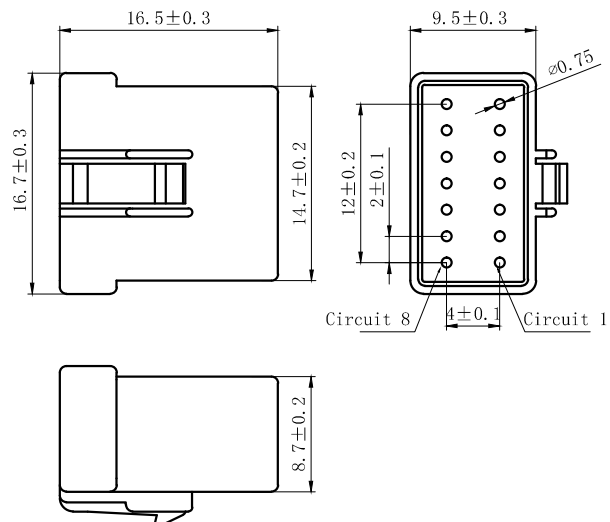

REV.	REVISION DESCRIPTION	DATE	APPD

NOTES

Available in 10.12.14 Circuits.
 Mates with DL20023 Series Housing.
 Material : PBT UL94V-0(2).
 Accepts DL20023-T Crimp Terminal.
 Green Material RoHS Compliant.

GENERAL TOLERANCES (UNLESS SPECIFIED)		ZHE JIANG DELI CONNECTORS CO.,LTD	
.X: ± 0.30	X° ± 3.0°	PRODUCT NAME: DL20023-Y-0.75	TITLE: 2.0 mm Pitch Housing
.XX: ± 0.15	.X° ± 2.0°	DR:Chen Quan Long	DATE:21/08/01
.XXX: ± 0.01	.X° ± 1.0°	CHKD:Wu Hui	DATE:21/08/01
FINISH: _____		APPD:Ren An De	DATE:21/08/01
DRAWING NO:			

REV.	REVISION DESCRIPTION	DATE	APPD

NOTES

Mates with DL20023-Y or DL20023-R Series Housing.

Material : PBT UL94V-0(2).

Green Material RoHS Compliant.

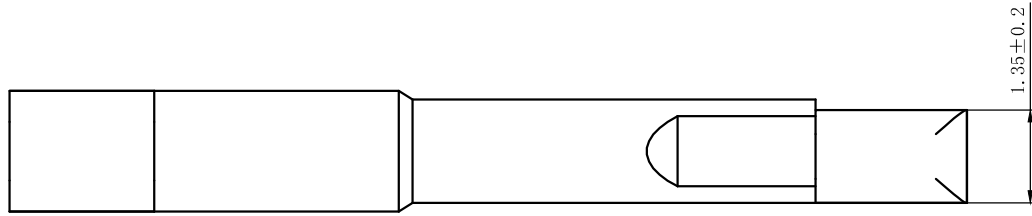
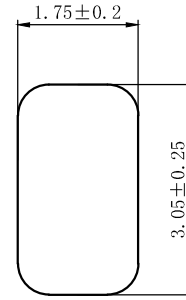
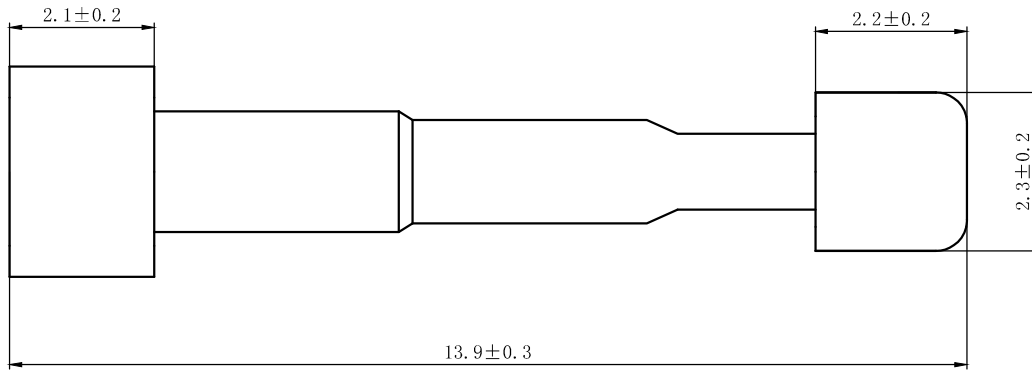

GENERAL TOLERANCES (UNLESS SPECIFIED)		ZHE JIANG DELI CONNECTORS CO., LTD	
.X: ± 0.30	X° : ± 3.0°	PRODUCT NAME: DL20023-1E	TITLE: 2.0 mm Pitch Wire To Wire Receptacle Stopper
.XX: ± 0.15	.X° : ± 2.0°	DR:KeXianQiang	DATE:17.10.12
.XXX: ± 0.01	.XX° : ± 1.0°	CHKD: Liu Bing	DATE:17.10.12
FINISH: _____		APPD:Ren An De	DATE:17.10.12
DRAWING NO:		SCALE: N/A	PAGE:1/1
		UNITS: mm	REV. : A

REV.	REVISION DESCRIPTION	DATE	APPD

NOTES

Used in DL20023-Y Series Housing.
 Accepts AWG #26~22 Wire Range.
 0.13~ 0.33 mm² .
 Insulation O. D. =1.4~1.7mm.
 Material : Phosphor Bronze .
 Finish: Tin plated.
 Qty/Reel: 10,000 PCS.
 Thickness: 0.25 mm.

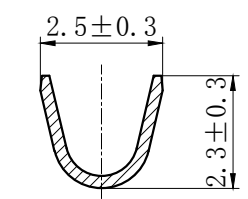
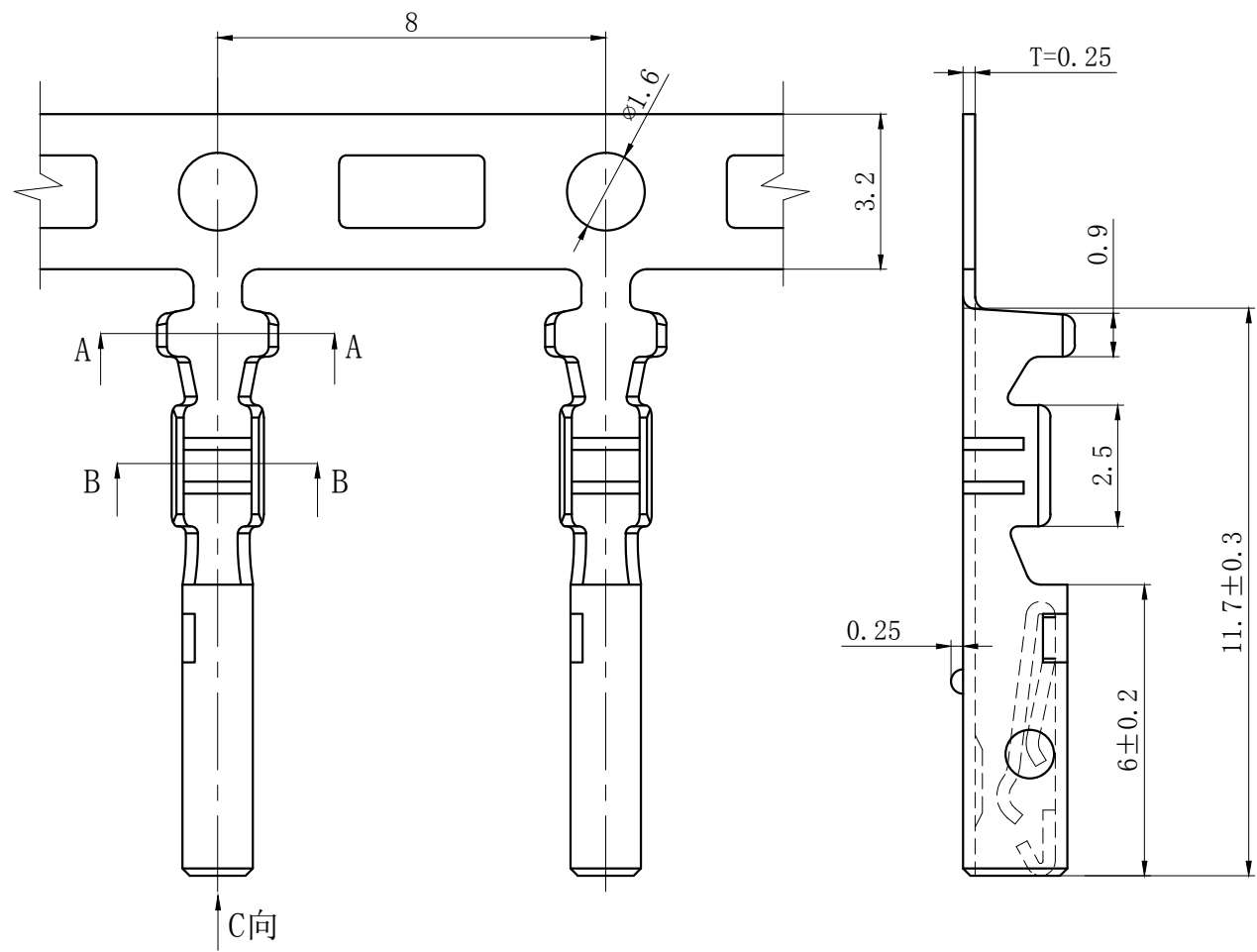

SECTION A-A

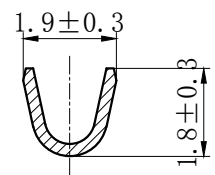

SECTION B-B

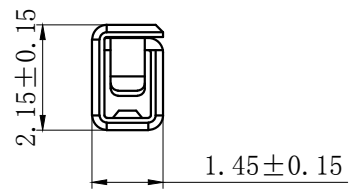

SECTION C-C

GENERAL TOLERANCES (UNLESS SPECIFIED)		ZHE JIANG DELI CONNECTORS CO., LTD	
.X: ± 0.25	X° : ± 3.0°	PRODUCT NAME: DL20023-T	TITLE: 2.00 mm Pitch Crimp Terminal
.XX: ± 0.15	.X° : ± 2.0°	DR:Chen Quan Long	DATE:20/12/23
.XXX: ± 0.01	.XX° : ± 1.0°	CHKD:Wu Hui	DATE:20/12/23
DRAWING NO:		APPD:Ren An De	DATE:20/12/23
		SCALE: N/A	PAGE: 1/1
		UNITS: mm	REV.: A

REV.	REVISION DESCRIPTION	DATE	APPD

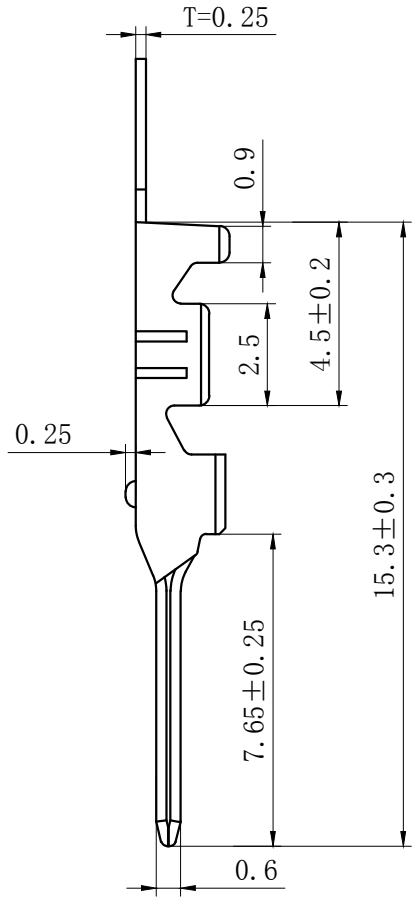
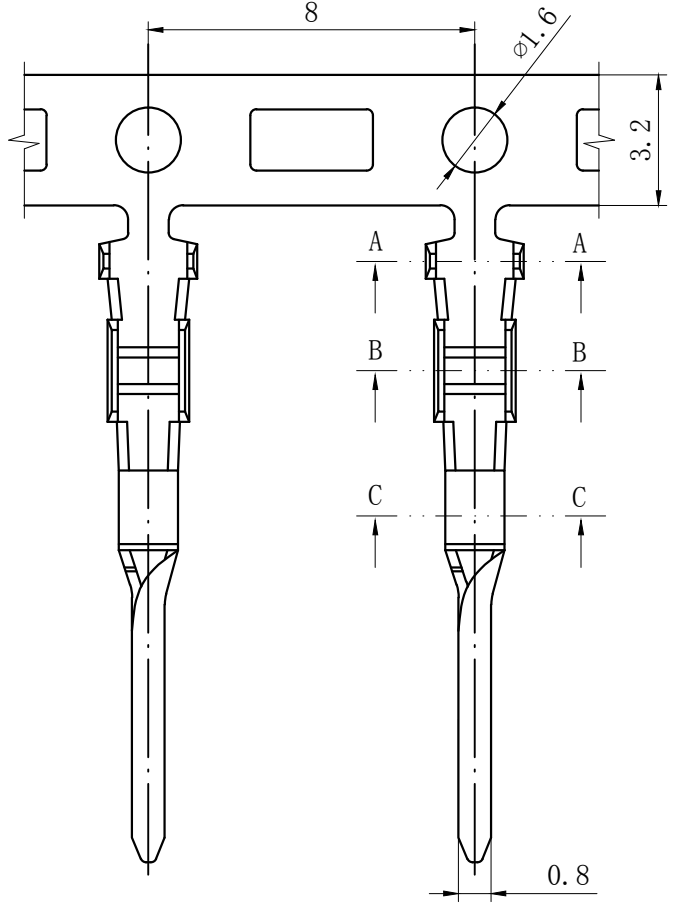

NOTES

Used in DL20023-R Series Housing.
 Accepts AWG #26~22 Wire Range.
 0.13~ 0.33 mm² .
 Insulation O.D.=1.4~1.7mm.
 Material : Phosphor Bronze .
 Finish: Tin plated.
 Qty/Reel: 10,000 PCS.
 Thickness: 0.25 mm.

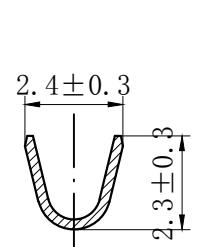

SECTION A-A

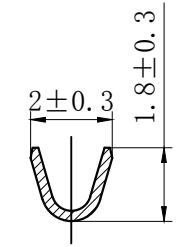

SECTION B-B

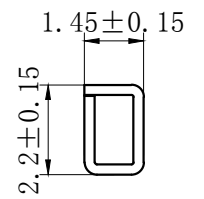

SECTION C-C

GENERAL TOLERANCES (UNLESS SPECIFIED)		ZHE JIANG DELI CONNECTORS CO., LTD	
.X: ± 0.25	X° : ± 3.0°	PRODUCT NAME: DL20023-RT	TITLE: 2.00 mm Pitch Wire To Wire Crimp Terminal
.XX: ± 0.15	.X° : ± 2.0°	DR:Chen Quan Long	DATE:20/12/23
.XXX: ± 0.01	.XX° : ± 1.0°	CHKD:Wu Hui	DATE:20/12/23
DRAWING NO:		APPD:Ren An De	DATE:20/12/23
		SCALE: N/A	PAGE: 1/1
		UNITS: mm	REV.: A