



WGF65R900G

Features:

- Super Junction technology
- Much lower Ron*A Performance for On-state efficiency
- Better efficiency due to very low FOM
- Ultra-fast body diode
- VDSS=650V, ID=6A
- $R_{DS(on)} : 0.78\Omega$ (Typ) @VG=10V



TO-220F

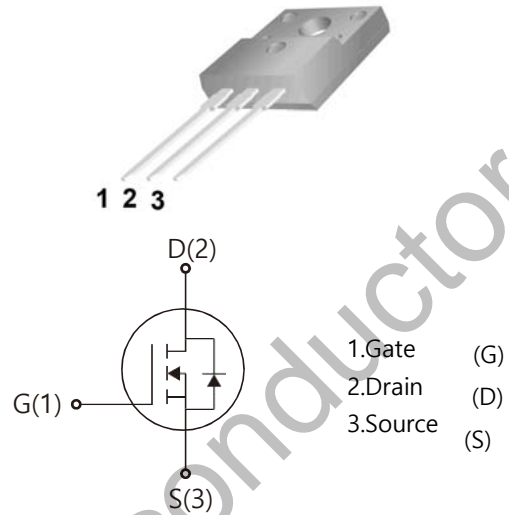

Absolute Maximum Ratings

Parameter	Symbol	Value	Unit
Drain-source voltage	V_{DS}	650	V
Continuous drain current	I_D	6.0	A
$T_C = 25^\circ C$		4.0	
$T_C = 100^\circ C$			
Pulsed drain current ($T_C = 25^\circ C$, t_p limited by T_{jmax})	$I_{D\ pulse}$	25	A
Avalanche energy, single pulse ($L=60mH$, $R_g=30\Omega$)	E_{AS}	60	mJ
Gate-Source voltage	V_{GS}	± 30	V
Power dissipation ($T_C = 25^\circ C$)	P_{tot}	71	W
Operating junction and storage temperature	T_j, T_{stg}	-55...+150	$^\circ C$

Thermal Resistance

Parameter	Symbol	Value	Unit
Thermal resistance, junction – case. Max	R_{thJC}	1.76	$^\circ C/W$
Thermal resistance, junction – ambient. Max	R_{thJA}	134	

Electrical Characteristic (at $T_j = 25\text{ }^\circ\text{C}$, unless otherwise specified)

Parameter	Symbol	Value			Unit	Test Condition
		min.	typ.	max.		
Static Characteristic						
Drain-source breakdown voltage	BV_{DSS}	700	-	-	V	$V_{GS}=0V, I_D=250\mu A$
Gate threshold voltage	$V_{GS(th)}$	3	3.5	4	V	$V_{DS}=V_{GS}, I_D=250\mu A$
Zero gate voltage drain current	I_{DSS}	-	-	1	μA	$V_{DS}=700V, V_{GS}=0V$ $T_C=25^\circ C$ $T_C=150^\circ C$
Gate-source leakage current	I_{GSS}	-	-	100	nA	$V_{GS}=\pm 30V, V_{DS}=0V$
Drain-source on-state resistance	$R_{DS(on)}$	-	0.78	0.90	Ω	$V_{GS}=10V, I_D=3A,$ $T_C=25^\circ C$ $T_C=150^\circ C$
Transconductance	g_{fs}	-	5	-	S	$V_{DS}=20V, I_D=3A$
Dynamic Characteristic						
Input Capacitance	C_{iss}	-	327	-	pF	$V_{GS}=0V, V_{DS}=100V, f=1MHz$
Output Capacitance	C_{oss}	-	25	-		
Reverse Transfer Capacitance	C_{rss}	-	23	-		
Gate Total Charge	Q_G	-	11	-	nC	$V_{GS}=10V, V_{DS}=480V, I_D=3A,$ $f=1MHz$
Gate-Source charge	Q_{gs}	-	2.5	-		
Gate-Drain charge	Q_{gd}	-	4.6	-		
Turn-on delay time	$t_{d(on)}$	-	12.6	-	ns	$T_j=25^\circ C, V_{GS}=10V, I_D=3A,$ $V_{DS}=400V, R_g=25\Omega$
Rise time	t_r	-	13.4	-		
Turn-off delay time	$t_{d(off)}$	-	50	-		
Fall time	t_f	-	61	-		
Gate resistance	R_G	-	9.0	-	Ω	$V_{GS}=0V, V_{DS}=0V, f=1MHz$

Body Diode Characteristic

Parameter	Symbol	Value			Unit	Test Condition
		min.	typ.	max.		
Body Diode Forward Voltage	V_{SD}	0.5	0.84	1	V	$V_{GS}=0V, I_{SD}=3A$
Body Diode Reverse Recovery Time	t_{rr}	-	185	-	ns	$I_{sd}=3A$ $dI/dt=100A/\mu s, V_{ds}=100V$
Body Diode Reverse Recovery Charge	Q_{rr}	-	1.47	-	μC	

Typical Performance Characteristics

Fig 1. Output Characteristics (Tj=25°C)

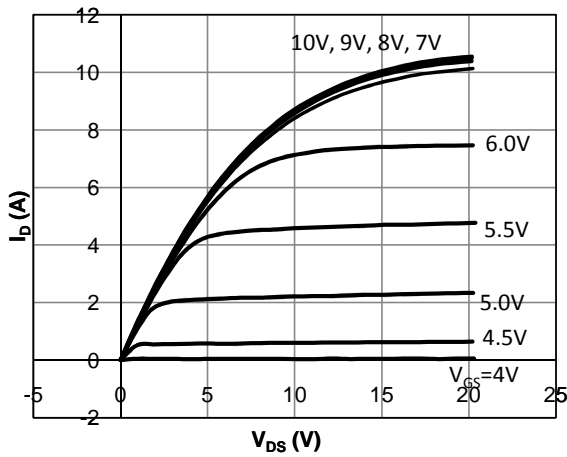

Fig 2. Output Characteristics (Tj=150°C)

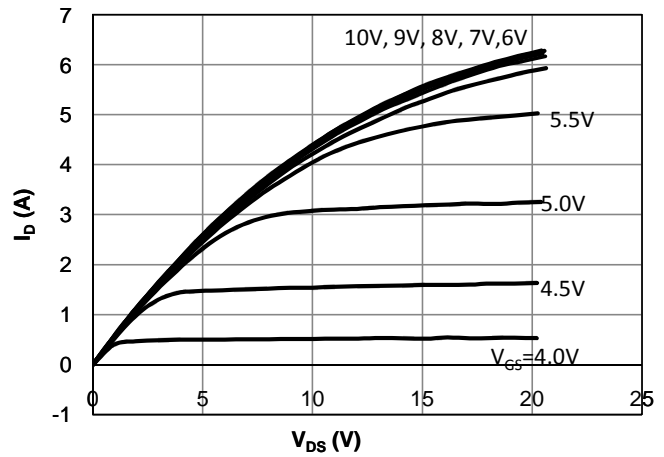

Fig 3: Transfer Characteristics

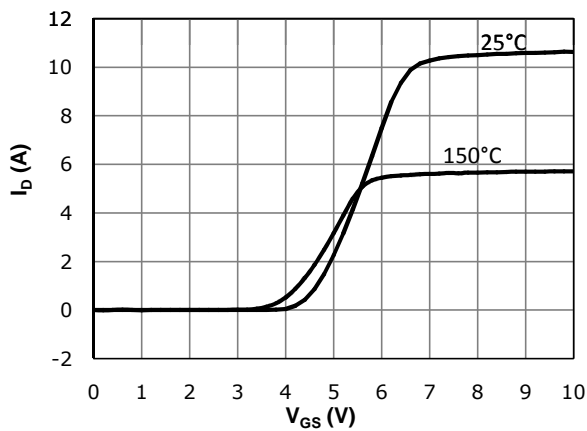

Fig 4: V_{TH} Vs Tj Temperature Characteristics

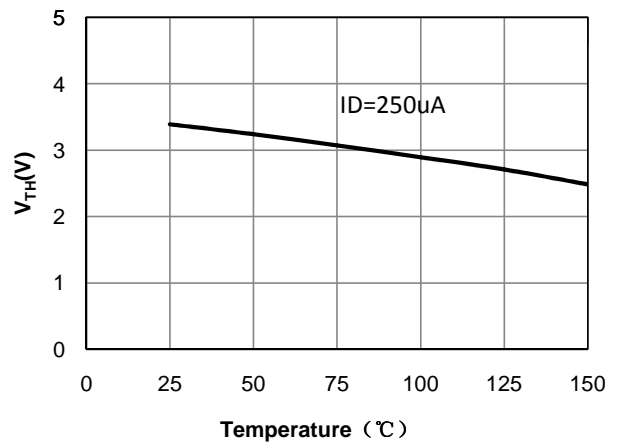

Fig 5: $R_{DS(on)}$ Vs I_{DS} Characteristics ($T_c = 25^\circ\text{C}$)

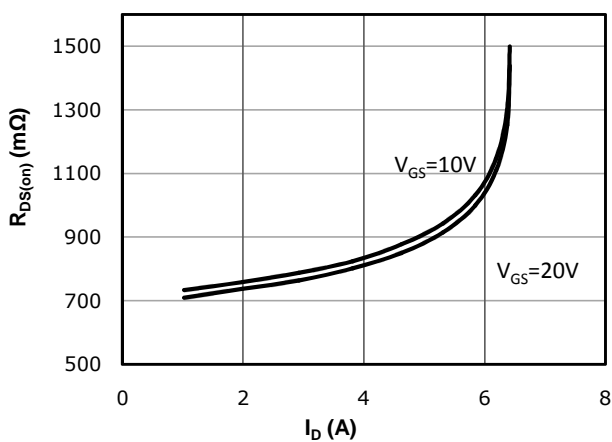

Fig 6: $R_{DS(on)}$ vs. Temperature

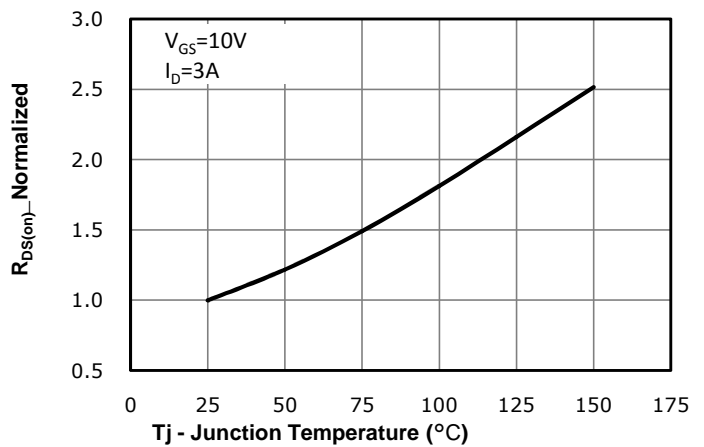

Fig 7: BVdss vs. Temperature

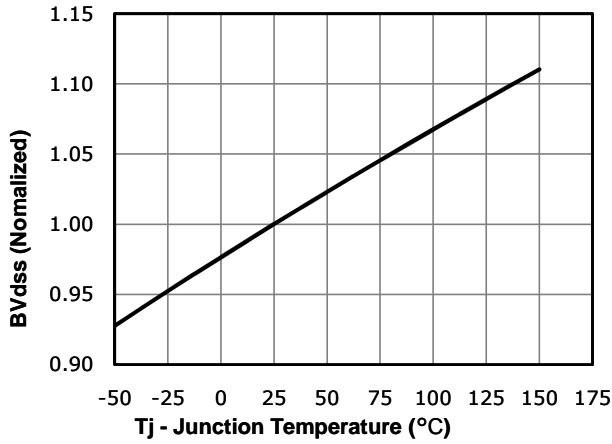

Fig 8: Rds(on) vs Gate Voltage

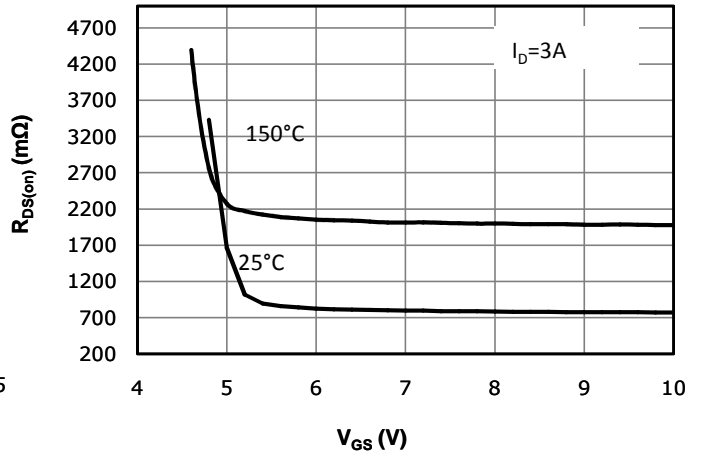

Fig 9: Body-diode Forward Characteristics

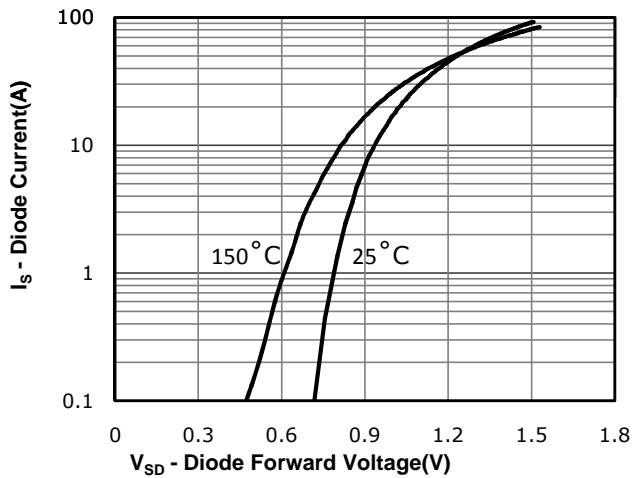

Fig 10: Gate Charge Characteristics

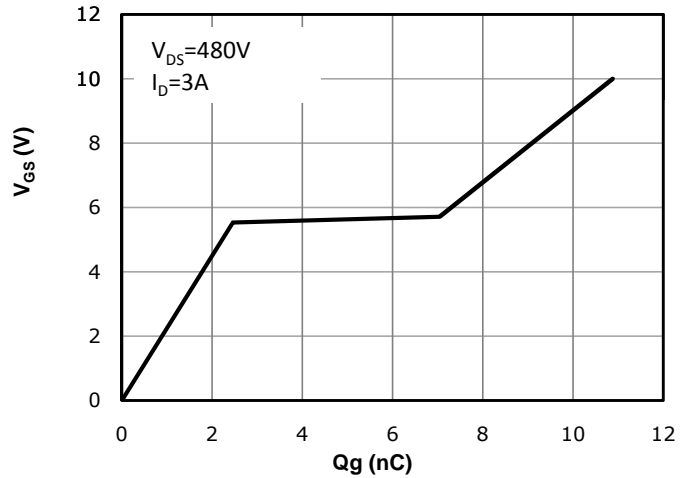

Fig 11: Capacitance Characteristics

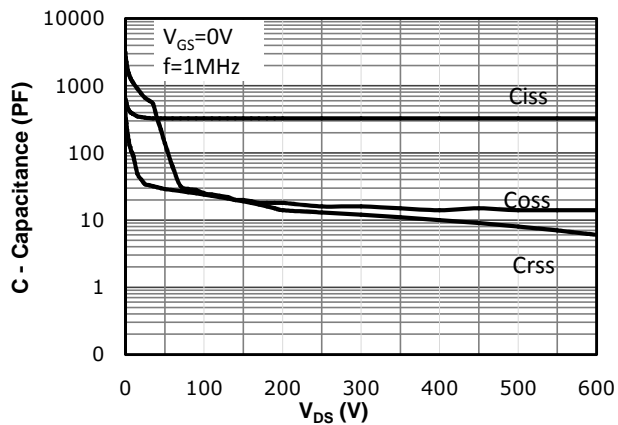

Fig 12: Safe Operating Area

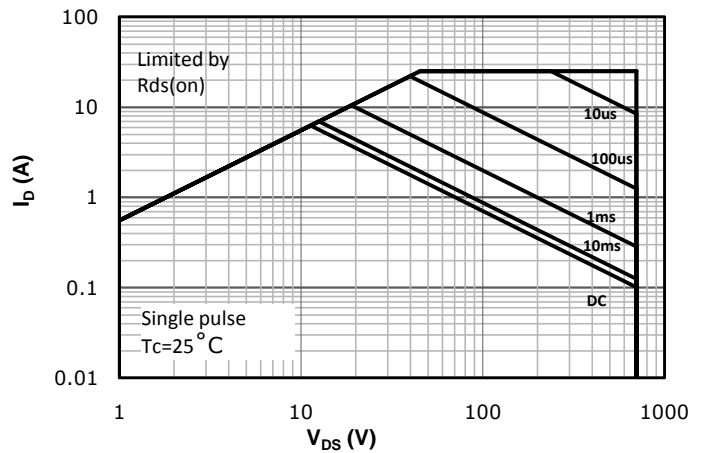
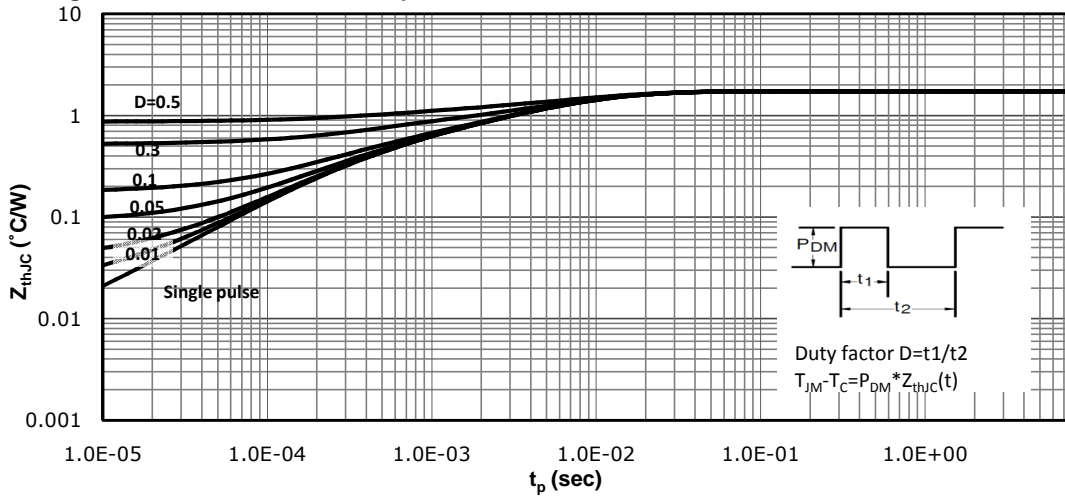

Fig 13: Max. Transient Thermal Impedance



WildGoose Semiconductor

Test Circuit & Waveform

Gate Charge Test Circuit & Waveform

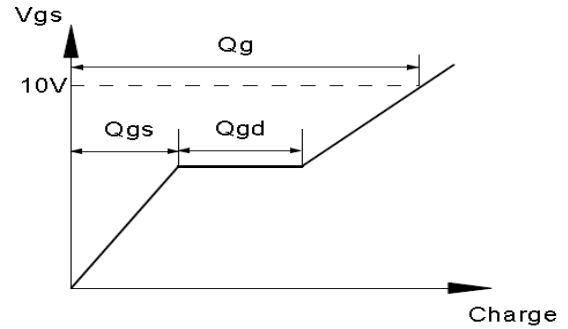
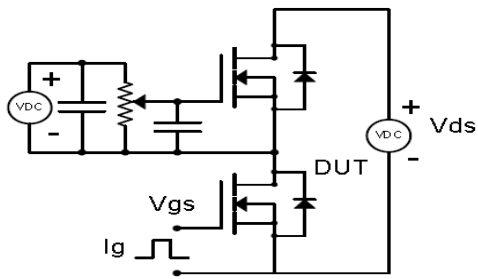

Resistive Switching Test Circuit & Waveforms

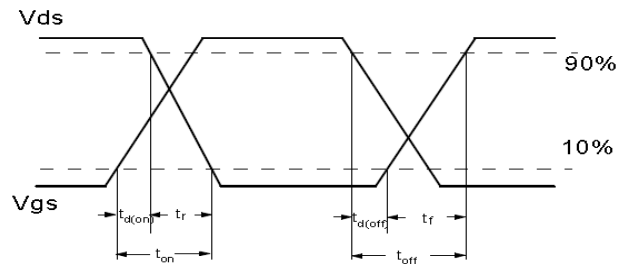
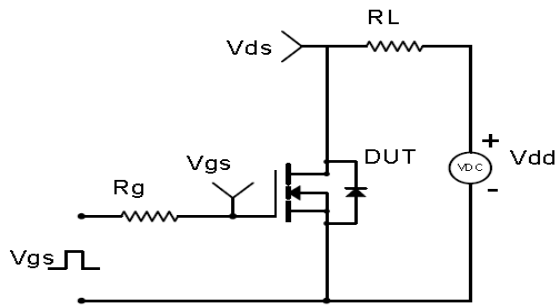

Unclamped Inductive Switching (UIS) Test Circuit & Waveforms

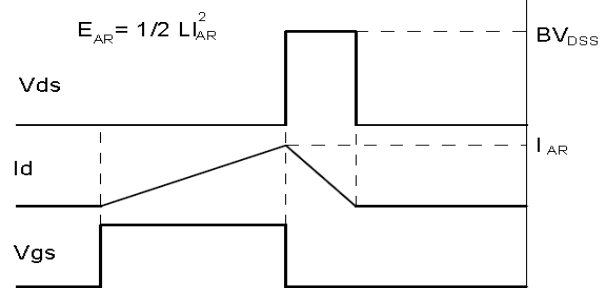
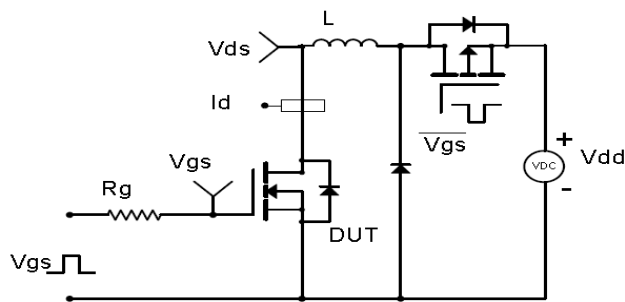

Diode Recovery Test Circuit & Waveforms

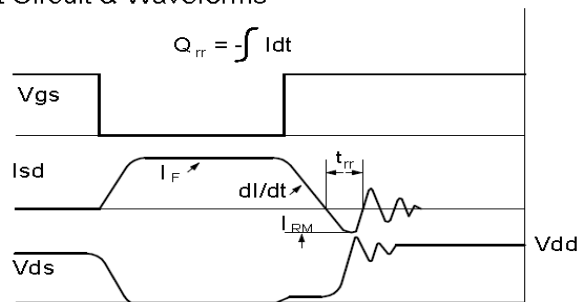
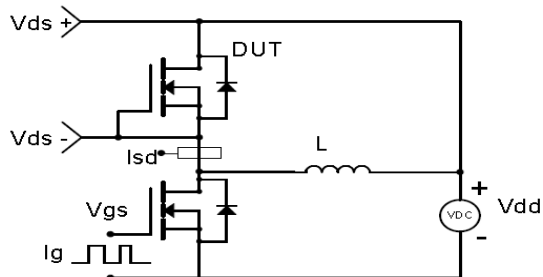

Package Dimension

TO-220F

Unit: mm

