

# HIGH POWER THICK FILM CHIP RESISTOR

TYPE CRGH SERIES | AEC-Q200 QUALIFIED

## INTRODUCTION

The resistive element is screen printed and fired, and a passivation layer added. Each resistor is trimmed to tolerance by laser. The pre-scribed tile is then broken into strips, the end plating fired on, and the strips broken into individual components. Final termination finish is electroplated matte Sn over a Ni barrier layer. This high power resistor is now AEC-200 Qualified.

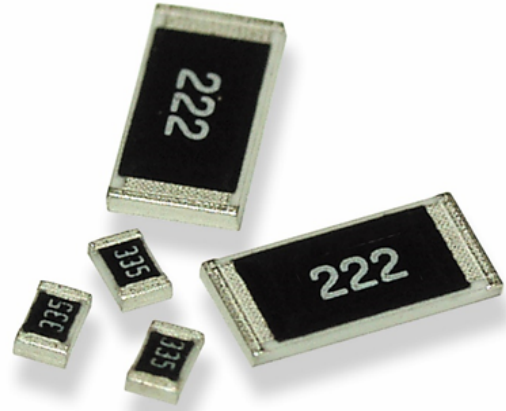

## FEATURES

- Thick film resistors with high power to size ratio, ideally suited to industrial and general purpose use
- Value range from 1Ω to 10MΩ
- Seven Package sizes
- Terminal finish matte Sn over Ni
- AEC-Q200 Qualified

## CHARACTERISTICS - ELECTRICAL

Type	0402	0603	0805	1206	1210	2010	2512
Power Rating (W) @70°C	0.1	0.2	0.33	0.5	0.75	1	2
Resistance Range E24 Standard Values E96 by negotiation	1Ω - 10MΩ						
Tolerance	1% - 5%						
Max. Working Voltage (V)	50	50	150	200	200	200	250
Max. Overload Voltage (V)	100	100	300	400	500	500	500
Dielectric strength	100	300	500	500	500	500	500
Temperature Range	-55°C - 155°C						
Ambient Temperature	70°C						

### Notes:

1. \* Rated continuous working voltage (RCWV) shall be determined from  $RCWV = \sqrt{\text{Rated Power} \times \text{Resistance Value}}$ , or Maximum RCWV listed above, whichever is less
2. \*\*Recommended Circuit Board Design - If this device is anticipated to run at full continuous power then action to improve the cooling should be taken. This can be a metal substrate, copper pad left under the chip, an opening in the PCB or enlarged silver conductor pads each end.

# High Power Thick Film Chip Resistor

Type CRGH Series I AEC-Q200 Qualified

## DERATING CURVE

Resistors shall have a power rating based on continuous load operation at an ambient temperature of 70°C. For temperature more than 70°C, the load shall be derated as shown below

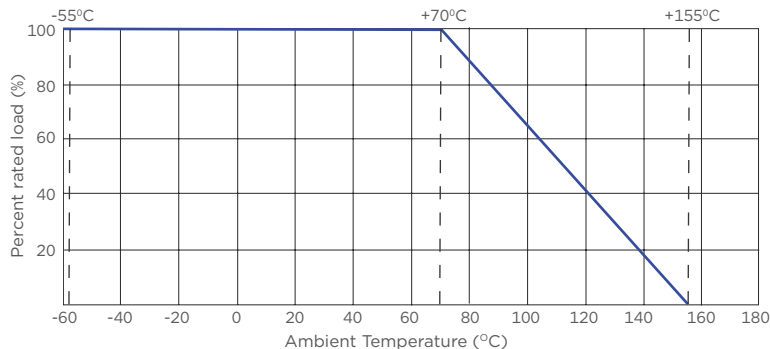

## VOLTAGE RATING

Resistors shall have a rated direct-current (DC) continuous working voltage or an approximate sine-wave root-mean-square (RMS) alternating-current (AC) continuous working voltage at commercial-line frequency and waveform corresponding to the power rating, as determined from the following formula:

$$RCWV = \sqrt{P \times R}$$

Where:

RCWV = Rated DC or RMS AC continuous working voltage at commercial-line frequency and waveform (volt)

P = Power Rating (watt)

R = Nominal Resistance (ohm)

In no case shall the rated DC or RMS AC continuous working voltage be greater than the applicable maximum value.

## CONSTRUCTION

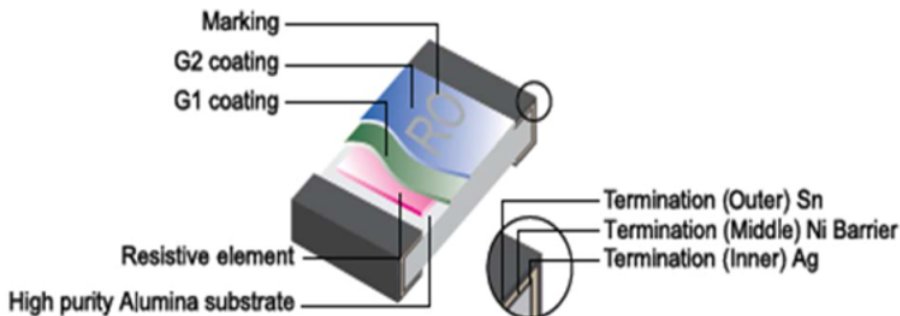

## DIMENSIONS (mm)

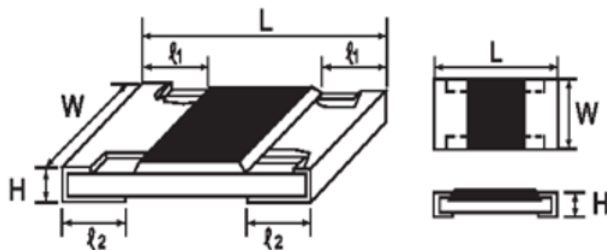

# High Power Thick Film Chip Resistor

Type CRGH Series I AEC-Q200 Qualified

## DIMENSIONS (mm)

Type	L	W	H	Ø1	Ø2
0402	1.00 ± 0.10	0.50 ± 0.05	0.35 ± 0.05	0.20 ± 0.10	0.25 ± 0.10
0603	1.60 ± 0.10	0.80 + 0.15/ - 0.10	0.45 ± 0.10	0.30 ± 0.20	0.30 ± 0.20
0805	2.00 ± 0.15	1.25 + 0.15/- 0.10	0.55 ± 0.10	0.40 ± 0.20	0.40 ± 0.20
1206	3.10 ± 0.15	1.55 + 0.15/- 0.10	0.55 ± 0.10	0.45 ± 0.20	0.45 ± 0.20
1210	3.10 ± 0.10	2.60 + 0.15/- 0.10	0.55 ± 0.10	0.50 ± 0.20	0.50 ± 0.20
2010	5.00 ± 0.10	2.50 + 0.15	0.55 ± 0.10	0.60 ± 0.25	0.50 ± 0.20
2512	6.35 ± 0.10	3.20 + 0.15	0.55 ± 0.10	0.60 ± 0.25	0.50 ± 0.20

## ENVIRONMENTAL CHARACTERISTICS

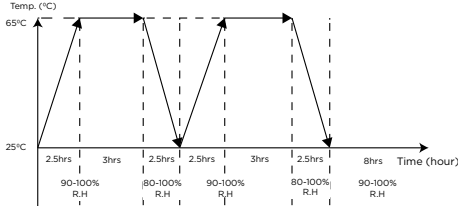
Characteristics	Standards	Test Methods (AEC Q-200)
Operational Life	±(1.0%+0.1Ω)max.	125°C, at 35% of operating power, 1000H(1.5 hours “ON”, 0.5 hour “OFF”). (MIL-STD-202 Method 108)
	<100mΩ	Apply to rate current for 0Ω
Electrical Characterization	1Ω≤R≤10Ω : ±400PPM/°C 10Ω≤R≤100Ω±±200PPM/°C 100≤R≤10MΩ±±100PPM/°C	Parametrically test lot and sample size requirements, summary to show Min, Max, Mean and Standard deviation at room as well as Min and Max operating temperature. (User Spec)
External Visual	No mechanical damage	Electrical test not required. Inspect device construction, marking and workmanship (MIL-STD-883 Method 2009)
Physical Dimension	Reference 2.0 Dimension Standards	Verify physical dimensions to the applicable device detail specification. Note: User(s) and suppliers spec. Electrical test not required. (JESD22 MH Method JB-100)
Resistance to Solvent	Marking Unsmearred	Note: Add Aqueous wash chemical – OKEM Clean or equivalent. Do not use banned solvents. (MIL-STD-202 Method 215)
Terminal Strength	Not broken	Force of 1.8kg for 60 seconds (JIS-C-6429)
High Temperature Exposure (Storage)	±(1.0%+0.1Ω)max.	1000hrs. @T=155°C. Unpowered. Measurement at 24±2 hours after test conclusion. (MIL-STD-202 Method 108)
	<50mΩ	Apply to rate current for 0Ω
Temperature Cycling	Resistance change rate is ±(0.5%+0.1Ω)max.	1000 Cycles (-55°C to +155°C). Measurement at 24±2 hours after test conclusion. (JESD22 Method JA-104)
	<50mΩ	Apply to rate current for 0Ω
Moisture Resistance	Resistance change rate is ±(0.5%+0.1Ω)max.	 <p>T=24 hours / cycle. Unpowered. Measurement at 24±2 hours after test conclusion. (MIL-STD-202 Method 106)</p>

# High Power Thick Film Chip Resistor

Type CRGH Series I AEC-Q200 Qualified

## ENVIRONMENTAL CHARACTERISTICS

Characteristics	Standards	Test Methods (AEC Q-200)																								
Biased Humidity	Resistance change rate is $\pm(1.0\%+0.1\Omega)$ max.	10% rated power, 85°C/85%RH, 1000H, Measurement at 24 hours after test conclusion. (MIL-STD-202 Method 103)																								
	<100mΩ	Apply to rate current for 0Ω																								
Mechanical Shock	Resistance change rate is $\pm(1.0\%+0.1\Omega)$ max.	Wave Form: Tolerance for half sine shock pulse. Peak value is 100g's. Normal duration (D) is 6. (MIL-STD202 Method 213)																								
Vibration	Resistance change rate is $\pm(1.0\%+0.1\Omega)$ max.	5g's for 20min., 12 cycle each of 3 orientations. Note: Use 8"*5"PCB. 031" thick 7 secure points (onone) long side and 2 secure points at corners of opposite sides. Parts mounted within 2' from any secure point. Test from 10-2000Hz. (MIL-STD-202 Method 204)																								
Thermal Shock	Resistance change rate is $\pm(1.0\%+0.1\Omega)$ max.	-55°C/=155°C, Note: Number of cycles required -300, Maximum transfer time -20 seconds, Dwell time -15 minutes. Air-Air. (MIL-STD-202 Method 107)																								
	<50mΩ	Apply to rate current for 0Ω																								
ESD	Resistance change rate is $\pm(10\%+0.1\Omega)$ max.	With the electrometer in direct contact with the discharge tip, verify the voltage setting at levels of $\pm 500V$ , $\pm 1KV$ , $\pm 2KV$ , $\pm 4KV$ , $\pm 8KV$ , The electrometer reading shall be within $\pm 10\%$ for voltages from 500V to $\leq 800V$ . (AEC-Q200-002)																								
	<table border="1"> <thead> <tr> <th>Type</th> <th>Max Voltage</th> <th>Class</th> </tr> </thead> <tbody> <tr> <td>0402</td> <td>0.5KV</td> <td>1B</td> </tr> <tr> <td>0603</td> <td>1KV</td> <td>1C</td> </tr> <tr> <td>0805</td> <td>2KV</td> <td>2</td> </tr> <tr> <td>1206</td> <td>3KV</td> <td>2</td> </tr> <tr> <td>1210</td> <td>6KV</td> <td>3A</td> </tr> <tr> <td>2010</td> <td>6KV</td> <td>3A</td> </tr> <tr> <td>2512</td> <td>10KV</td> <td>3B</td> </tr> </tbody> </table>		Type	Max Voltage	Class	0402	0.5KV	1B	0603	1KV	1C	0805	2KV	2	1206	3KV	2	1210	6KV	3A	2010	6KV	3A	2512	10KV	3B
	Type		Max Voltage	Class																						
	0402		0.5KV	1B																						
	0603		1KV	1C																						
	0805		2KV	2																						
	1206		3KV	2																						
	1210		6KV	3A																						
2010	6KV	3A																								
2512	10KV	3B																								
Solderability	95% coverage Min.	For both leaded and SMD. Electrical test not required. Magnification 50X Conditions: a. Method B 4hrs at 155°C dry heat, the dip in bath with 245°C,5s. b. Method B: at 215°C,5S. c. Method D: at 260°C, 60s. (J-STD-002)																								
Flammability	No ignition of the tissue paper or scorching of the pinewood board	V-0 or V-1 are acceptable. Electrical test not required. (UL-94)																								
Board Flex	$\pm(1.0\%+0.05\Omega)$ max	2mm (Min) (JIS-C-6429)																								
	<50mΩ	Apply to rate current for 0Ω																								
Flame Retardance	No flame	Temperature sensing at 500°C, Voltage power subjected to 32VDC current clamped up to 500ADC and decreased in 1.0VDC/hour. (AEC-Q200-001)																								
Resistance to Soldering Heat	Resistance change rate is $\pm(1.0\%+0.05\Omega)$ max	Condition B No per-heat of samples. Note: single wave solder-procedure 2 for SMD and procedure 1 for leaded with solder within 1.5mm of device body. (MIL-STD-202 Method 210)																								
	<50mΩ	Apply to rate current for 0Ω																								

\*Sulfuration test: H2S 3-5PPM 50°C $\pm$ 2°C 91%-93%RH 1000H

# High Power Thick Film Chip Resistor

Type CRGH Series I AEC-Q200 Qualified

## MARKING

E24 series 0603 - 2512 3 Digits - first two digits denote significant figures of resistance and third digit denotes number of zeros thereafter.

Example



Marking for E96 Series 0805 - 2512 4 digits - First three digits denote significant figures of resistance and fourth digit denotes number of zeros thereafter.

Example

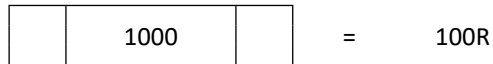

For ohmic values below 100R letter "R" denotes decimal point.

Example



0402 size chips are not marked

0603 E96 3 digit marking.

Resistance Code from table on next page, and Multiplier code from table below

## MULTIPLIER CODE

Code	A	B	C	D	E	F	G	H	X	Y	Z
Mutiplier	10 <sup>0</sup>	10 <sup>1</sup>	10 <sup>2</sup>	10 <sup>3</sup>	10 <sup>4</sup>	10 <sup>5</sup>	10 <sup>6</sup>	10 <sup>7</sup>	10 <sup>-1</sup>	10 <sup>-2</sup>	10 <sup>-3</sup>

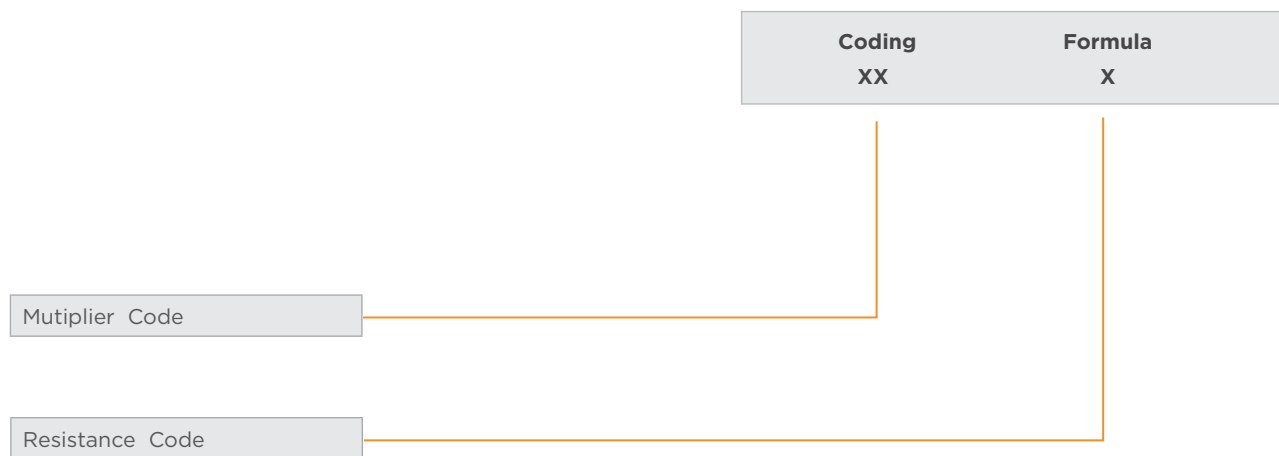

### Example:

10.2K Ω = 102 ↓ 02	X	10 Ω = 2C ↓ C
33.2 Ω = 332 ↓ 51	X	10 <sup>-1</sup> Ω = 51X ↓ X

# High Power Thick Film Chip Resistor

Type CRGH Series I AEC-Q200 Qualified

Value	Code	Value	Code	Value	Code	Value	Code		
100	1	162	21	261	41	422	61	698	82
102	2	165	22	267	42	432	62	715	83
105	3	169	23	274	43	442	63	732	84
107	4	174	24	280	44	453	64	750	85
110	5	178	25	287	45	464	65	768	86
113	6	182	26	294	46	475	66	787	87
115	7	187	27	301	47	487	67	806	88
118	8	191	28	309	48	499	68	825	89
121	9	196	29	316	49	511	69	845	90
124	10	200	30	324	50	523	70	866	91
127	11	205	31	332	51	536	71	887	92
130	12	210	32	340	52	549	72	909	93
133	13	215	33	348	53	562	73	931	94
137	14	221	34	357	54	576	74	953	95
140	15	226	35	365	55	590	75	976	96
143	16	232	36	374	56	604	76		
147	17	237	37	383	57	619	77		
150	18	243	38	392	58	634	78		
154	19	249	39	402	59	649	79		
158	20	255	40	412	60	665	80		

## LABEL

Label shall be marked with the following item:

- A. Nominal Resistance and Resistance Tolerance
- B. Power Rating and Size
- C. Quantity and description
- D. Part No.
- E. Lot No.

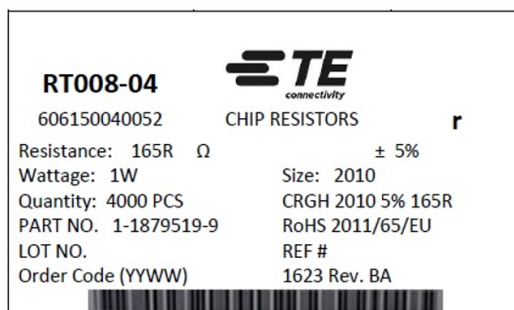

# High Power Thick Film Chip Resistor

Type CRGH Series I AEC-Q200 Qualified

## PACKAGING SPECIFICATION

### BOX DIMENSIONS (mm)

#### Paper Taping

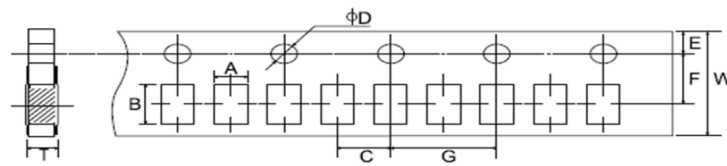

Type	A $\pm 0.1$	B $\pm 0.1$	C $\pm 0.05$	$\phi D +0.1 -0$	E $\pm 0.1$	F $\pm 0.05$	G $\pm 0.1$	W $\pm 0.2$	T $\pm 0.05$
0402	0.65	1.2	2.0	1.5	1.75	3.5	4.0	8.0	0.42

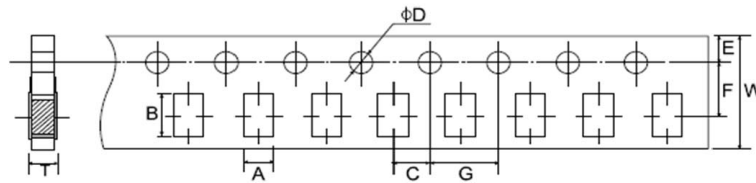

Type	A $\pm 0.2$	B $\pm 0.2$	C $\pm 0.05$	$\phi D +0.1 -0$	E $\pm 0.1$	F $\pm 0.05$	G $\pm 0.1$	W $\pm 0.2$	T $\pm 0.1$
0603	1.10	1.90	2.0	1.5	1.75	3.5	4.0	8.0	0.67
0805	1.65	2.40	2.0	1.5	1.75	3.5	4.0	8.0	0.81
1206	2.00	3.60	2.0	1.5	1.75	3.5	4.0	8.0	0.81
1210	2.80	3.50	2.0	1.5	1.75	3.5	4.0	8.0	0.75

#### Embossed Taping

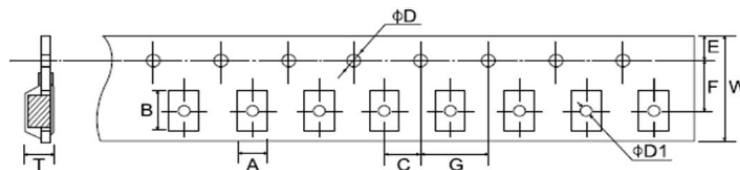

Type	A $\pm 0.2$	B $\pm 0.2$	C $\pm 0.05$	$\phi D +0.1 -0$	E $\pm 0.1$	F $\pm 0.05$	G $\pm 0.1$	W $\pm 0.2$	T $\pm 0.01$
2010	2.90	5.60	2.0	1.5	1.75	5.5	4.0	12.0	1.00
2512	3.50	6.70	2.0	1.5	1.75	5.5	4.0	12.0	1.00

### PEELING STRENGTH OF TOP COVER TAPE

Test Condition: 0.1 to 0.7 N at a peel-off speed of 300 mm / min.

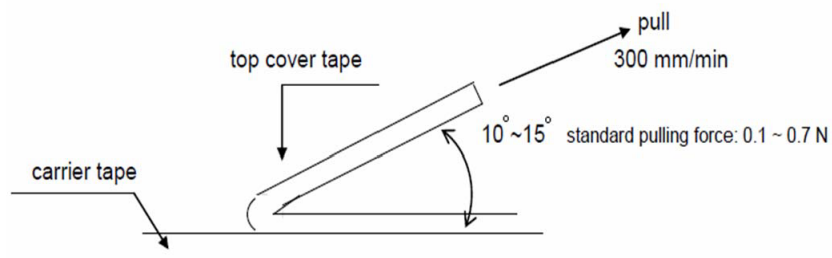

# High Power Thick Film Chip Resistor

Type CRGH Series I AEC-Q200 Qualified

## REEL DIMENSION (mm)

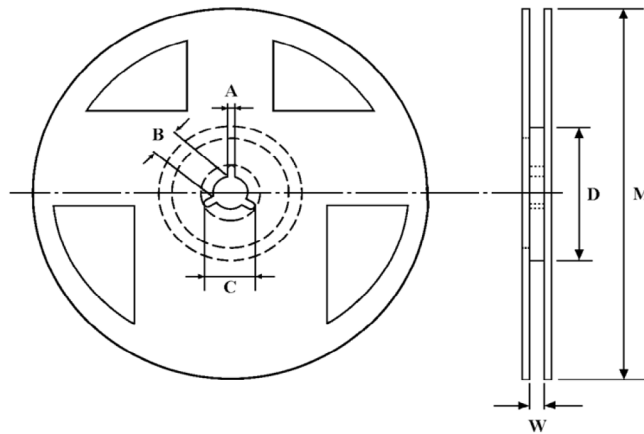

Type	Packaging	Quantity Per Reel	A ± 0.5	B ± 0.5	C ± 0.5	D ± 1.00	M ± 2	W ± 1.00
0402	Paper	10,000 pcs	2	13	21	60	178	10
0603	Paper	5,000 pcs	2	13	21	60	178	10
0805	Paper	5,000 pcs	2	13	21	60	178	10
1206	Paper	5,000 pcs	2	13	21	60	178	10
1210	Paper	5,000 pcs	2	13	21	60	178	10
2010	Embossed	4,000 pcs	2	13	21	60	178	13.8
2512	Embossed	4,000 pcs	2	13	21	60	178	13.8

## RECOMMENDED SOLDER PAD

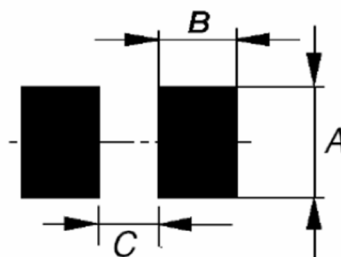

Type	A Width (mm)	B Width (mm)	C Width (mm)
0402	0.6	0.6	0.5
0603	1.0	1.0	0.6
0805	1.3	1.2	1.0
1206	1.8	1.2	2.2
1210	2.8	1.2	2.1
2010	3.0	1.5	3.8
2512	3.0	1.5	5.0



# High Power Thick Film Chip Resistor

Type CRGH Series I AEC-Q200 Qualified

---

## ENVIRONMENT RELATED SUBSTANCE

This product complies to EU RoHS directive, EU PAHs directive, EU PFOS directive and Halogen free.

## OZONE LAYER DEPLETING SUBSTANCES

Ozone depleting substances are not used in our manufacturing process of this product.

This product is not manufactured using Chloro fluorocarbons (CFCs), Hydrochlorofluorocarbons (HCFCs), Hydrobromofluorocarbons (HBFCs) or other ozone depleting substances in any phase of the manufacturing process.

## STORAGE CONDITION (MSL1)

The performance of these products, including the solderability, is guaranteed for a year from the date of arrival at your company, provided that they remain packed as they were when delivered and stored at a temperature of  $25^{\circ}\text{C} \pm 10^{\circ}\text{C}$  and a relative humidity of  $60\%RH \pm 10\%RH$ , chemical and dust free atmosphere.

Even within the above guarantee periods, do not store these products in the following conditions otherwise, their electrical performance and/or solderability may be deteriorated, and the packaging materials (e.g., taping materials) may be deformed or deteriorated, resulting in mounting failures.

1. In salty air or in air with a high concentration of corrosive gas, such as  $\text{Cl}_2$ ,  $\text{H}_2\text{S}$ ,  $\text{NH}_3$ ,  $\text{SO}_2$ , or  $\text{NO}_2$ .
2. In direct sunlight.

## ORDERING INFORMATION

**Part Number**  
**CRGH 0603 J 10K**

### Common Part

<b>CRGH</b>	High Power Thick Film Chip Resistor
-------------	-------------------------------------

### Size

<b>0402</b>
<b>0603</b>
<b>0805</b>
<b>1206</b>
<b>1210</b>
<b>2010</b>
<b>2512</b>

### Tolerance

<b>F</b>	1%
<b>J</b>	5%

### Resistance Value

<b>1R0</b>	1 ohm = 1000 milliohms
<b>1K0</b>	1K ohm = 1000 ohms
<b>100K</b>	100K ohm = 100000 ohms
<b>1M0</b>	1M ohm = 1000000 ohms

## te.com

©2023 TE Connectivity. All Rights Reserved.

TE Connectivity, TE connectivity (logo) and Every Connection Counts are trademarks. All other logos, products and/or company names referred to herein might be trademarks of their respective owners.

While TE has made every reasonable effort to ensure the accuracy of the information in this document, TE does not guarantee that it is error-free, nor does TE make any other representation, warranty or guarantee that the information is accurate, correct, reliable or current. TE reserves the right to make any changes to the information contained herein without prior notice. TE Connectivity assumes only those obligations set forth in the terms and conditions for this product and shall in no event be liable for any incidental, indirect, or consequential damages arising out of the sale, resale, use, or misapplication of the product. TE expressly disclaims any implied warranties with respect to the information contained herein, including, but not limited to, implied warranties of merchantability or fitness for a particular purpose. Dimensions, specifications and/or information contained herein are for reference purposes only and are subject to change without notice. Consult TE for the latest dimensions, specifications and/or information. Users of TE Connectivity products must make their own assessment as to whether the respective product is suitable for the respective desired application.

1773204-1 REV:G 08/23 ED