

962928-1 ✓ ACTIVE

AMP | Maxi Power Timer

TE Internal #: 962928-1

Automotive Terminals, Receptacle, Mating Tab Width 9.5 mm [.375 in], Tab Thickness 1.2 mm [.047 in], 13 – 11 AWG Wire Size, Maxi Power Timer

[View on TE.com >](#)



Terminals & Splices > Automotive Terminals > TIMER, RECEPTACLE AND TAB



Terminal Type: **Receptacle**

Mating Tab Width: **9.5 mm [.375 in]**

Mating Tab Thickness: **1.2 mm [.047 in]**

Terminal Transmits: **41 – 100 A (High Power)**

Wire Size: **13 – 11 AWG**

[All TIMER, RECEPTACLE AND TAB \(330\)](#)

Features

Product Type Features

Sealable	No
Primary Locking Feature	Locking Lance

Contact Features

Contact Size	9.5mm
Contact Fabrication	Stamped & Formed
Wire Contact Termination Area Plating Material	Tin
Typical Current Rating	78 A
Crimp Type	F-Crimp
Terminal Type	Receptacle
Mating Tab Width	9.5 mm[.375 in]
Mating Tab Thickness	1.2 mm[.047 in]
Interface Plating	Tin (Sn)

Termination Features

Termination Method to Wire & Cable	Crimp
Product Terminates To	Wire

Dimensions



Compatible Insulation Diameter Range	3.3 – 4.7 mm [.13 – .185 in]
Wire Size	2.5 – 4 mm ²
Wire Size Search	11 AWG, 12 AWG, 13 AWG
Tab Length	37.5 mm [1.47 in]

Usage Conditions

Insulation Option	Uninsulated
Operating Temperature (Max)	130 °C [266 °F]
Operating Temperature Range	-40 – 130 °C [-40 – 266 °F]

Operation/Application

Compatible With Wire Base Material	Copper
------------------------------------	--------

Industry Standards

Compatible With Agency/Standards Products	IEC 664/664A (DIN VDE 0110)
---	-----------------------------

Packaging Features

Packaging Quantity	600
Packaging Method	Reel

Other

Terminal Transmits	41 – 100 A (High Power)
--------------------	-------------------------

Product Compliance

[For compliance documentation, visit the product page on TE.com>](#)

EU RoHS Directive 2011/65/EU	Compliant
EU ELV Directive 2000/53/EC	Compliant
China RoHS 2 Directive MIIT Order No 32, 2016	No Restricted Materials Above Threshold
EU REACH Regulation (EC) No. 1907/2006	Current ECHA Candidate List: JUNE 2023 (235) Candidate List Declared Against: JUNE 2023 (235) Does not contain REACH SVHC
Halogen Content	Low Halogen - Br, Cl, F, I < 900 ppm per homogenous material. Also BFR/CFR/PVC Free
Solder Process Capability	Not applicable for solder process capability

Product Compliance Disclaimer

This information is provided based on reasonable inquiry of our suppliers and represents our current actual knowledge based on the information they provided. This information is subject to change. The part numbers that TE has identified as EU RoHS compliant have a maximum concentration of 0.1% by weight in homogenous materials for lead, hexavalent chromium, mercury, PBB, PBDE, DBP, BBP, DEHP, DIBP, and 0.01% for cadmium, or qualify for an exemption to these limits as defined in the Annexes of Directive 2011/65/EU (RoHS2). Finished electrical and electronic equipment products will be CE marked as required by Directive 2011/65/EU. Components may not be CE marked. Additionally, the part numbers that TE has identified as EU ELV compliant have a maximum concentration of 0.1% by weight in homogenous materials for lead, hexavalent chromium, and mercury, and 0.01% for cadmium, or qualify for an exemption to these limits as defined in the Annexes of Directive 2000/53/EC (ELV). Regarding the REACH Regulation, the information TE provides on SVHC in articles for this part number is based on the latest European Chemicals Agency (ECHA) 'Guidance on requirements for substances in articles' posted at this URL: <https://echa.europa.eu/guidance-documents/guidance-on-reach>

Compatible Parts



TE Part # 963764-2
TAB 9.5x1.2 CONTACT CF SRC Sn



TE Part # 1-1579007-7
EXTRACTION TOOL



TE Part # 1801616-1
FUSES HOLDER 10 MINIFUSES



TE Part # 1801617-1
FUSES AND RELAYS HOLDER 6 MINIFUSES



TE Part # 1801618-1
RELAY 40A HOLDER



TE Part # 1801619-1
RELAY 70A HOLDER



TE Part # 1801620-1
2 MICRORELAYS HOLDER



TE Part # 2-953615-2
MODULAR RELAY HLDR 50-60A



TE Part # 2151283-2
OCEAN_2.0_Applicator-S-155F210OV



TE Part # 2151492-2
OCEAN_2.0_Applicator-S-155F210F



TE Part # 7-2151283-7
OCEAN_2.0_SPARE_PART_KIT-155F210OV



TE Part # 7-2151492-7
OCEAN_2.0_SPARE_PART_KIT-155F210F



TE Part # 2151492-1
OC-AT-S-FM-155F210F-001-0211



TE Part # 3-1579017-5
HT33-SDE DIE SET, MPT 2.5 - 4.0 SQ. MM



TE Part # 1563255-1
2POS,MPT,REC HSG



TE Part # 1-953615-1
MODULAR RELAY HLDR 50-60A

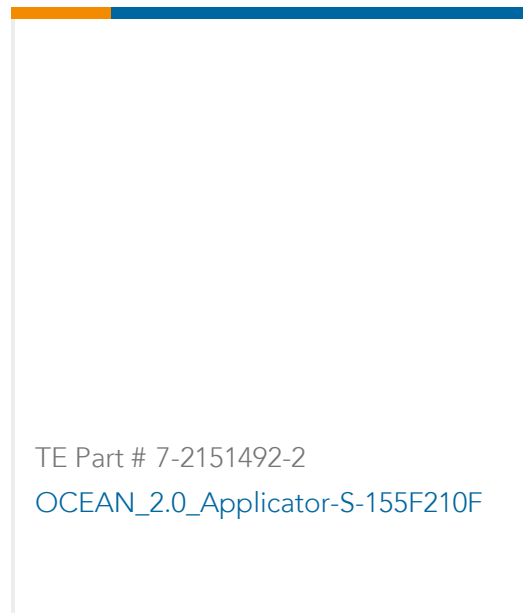

Also in the Series | Maxi Power Timer

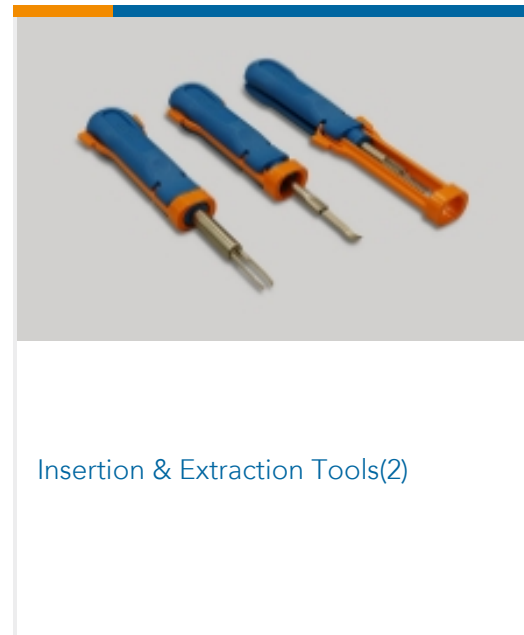
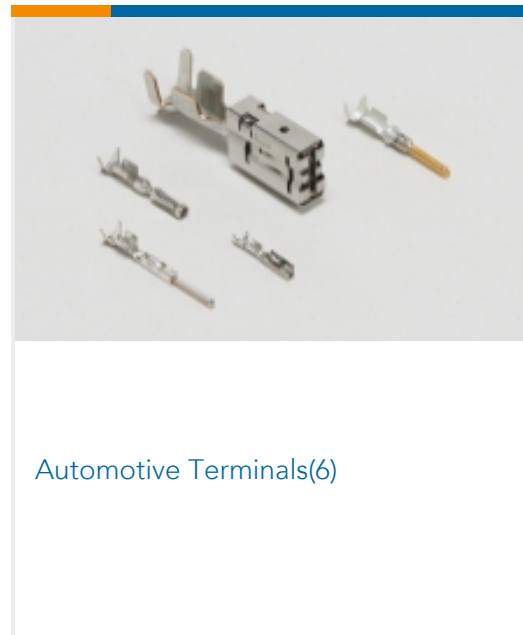
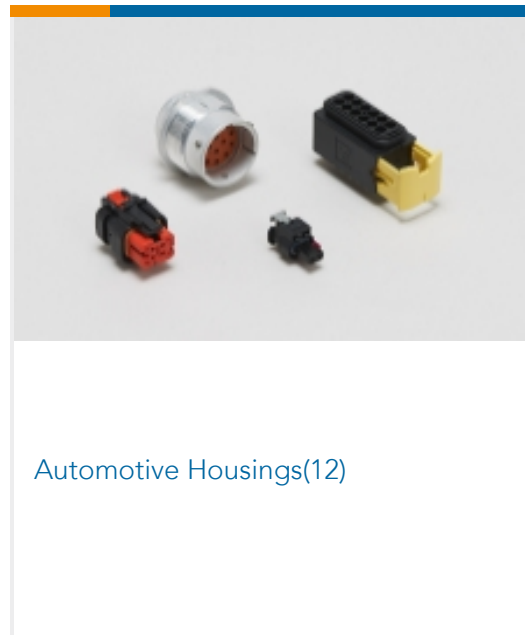

Customers Also Bought

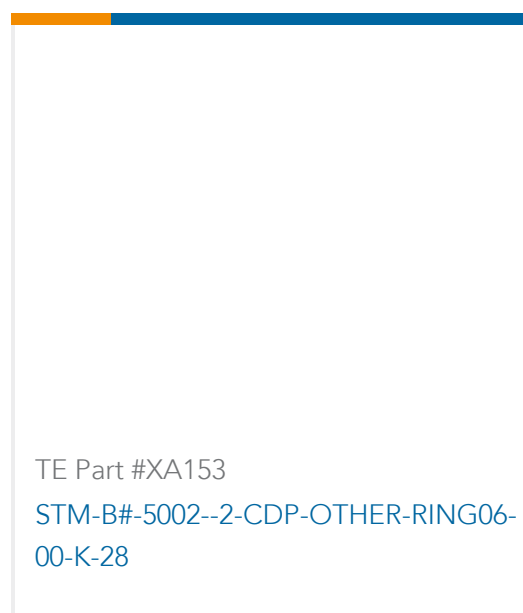
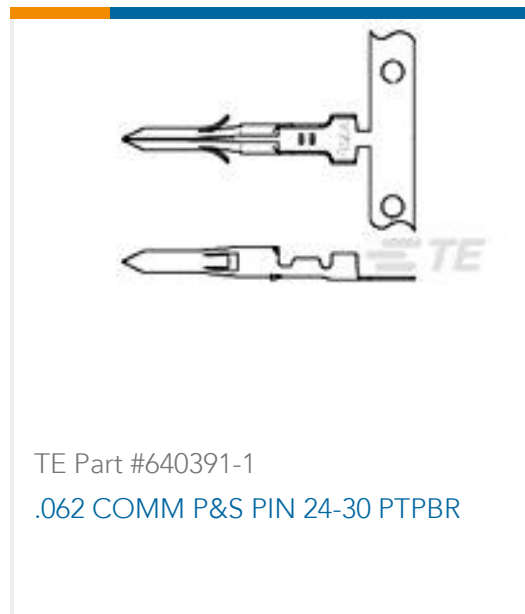



Documents

Product Drawings

[MPT REC 9.5 Contact SRC Sn](#)

English

CAD Files

Customer View Model

[ENG_CVM_962928-1_A4.3d_igs.zip](#)

English

Customer View Model

[ENG_CVM_962928-1_A4.3d_stp.zip](#)

English

Customer View Model

[ENG_CVM_962928-1_A4.2d_dxf.zip](#)

English

[3D PDF](#)

English

By downloading the CAD file I accept and agree to the [Terms and Conditions](#) of use.

Datasheets & Catalog Pages

[Timer Interconnection System](#)

English

Product Specifications

[Application Specification](#)

German

[Application Specification](#)

English

[Application Specification](#)

English