

61116-4 ✓ ACTIVE

MATE-N-LOK | Commercial MATE-N-LOK

TE Internal #: 61116-4

Pin Contact, Tin, 250 VAC, Locking Lance Contact Retention, 24 – 18 AWG Wire Size, .2 – .82 mm² Wire Size, Crimp, Commercial MATE-N-LOK

[View on TE.com >](#)



Connectors > Contacts > Connector Contacts



Contact Type: **Pin**

Contact Mating Area Plating Material: **Tin**

Wire Contact Termination Area Plating Material: **Tin**

Operating Voltage: **250 VAC**

Contact Retention Within Housing: **With**

Features

Product Type Features

Discrete Wire Type	Stranded
--------------------	----------

Electrical Characteristics

Operating Voltage	250 VAC
-------------------	---------

Contact Features

Mating Pin Diameter	2.13 mm[.084 in]
---------------------	------------------

Wire Contact Termination Area Plating Material Finish	Matte
---	-------

Contact Shape & Form	Round
----------------------	-------

Contact Orientation	Straight
---------------------	----------

Barrel Type	Open
-------------	------

Contact Type	Pin
--------------	-----

Contact Mating Area Plating Material	Tin
--------------------------------------	-----

Wire Contact Termination Area Plating Material	Tin
--	-----

Contact Retention Within Housing	With
----------------------------------	------

Contact Base Material	Phosphor Bronze
-----------------------	-----------------



Contact Current Rating (Max)	15 A
------------------------------	------

Termination Features

Termination Method to Wire & Cable	Crimp
Product Terminates To	Wire & Cable

Mechanical Attachment

Wire Insulation Support	Without
Contact Retention Type Within Housing	Locking Lance

Dimensions

Compatible Insulation Diameter Range	2.54 mm[.1 in]
Wire Size	.2 – .82 mm ²

Usage Conditions

Operating Temperature Range	-55 – 105 °C[-67 – 221 °F]
-----------------------------	----------------------------

Operation/Application

Circuit Application	Power
---------------------	-------

Packaging Features

Packaging Quantity	8000
Packaging Method	Reel

Product Compliance

[For compliance documentation, visit the product page on TE.com>](#)

EU RoHS Directive 2011/65/EU	Compliant
EU ELV Directive 2000/53/EC	Compliant
China RoHS 2 Directive MIIT Order No 32, 2016	No Restricted Materials Above Threshold
EU REACH Regulation (EC) No. 1907/2006	Current ECHA Candidate List: JUNE 2023 (235) Candidate List Declared Against: JUNE 2023 (235) Does not contain REACH SVHC
Halogen Content	Low Halogen - Br, Cl, F, I < 900 ppm per homogenous material. Also BFR/CFR/PVC Free
Solder Process Capability	Not applicable for solder process capability

Product Compliance Disclaimer

This information is provided based on reasonable inquiry of our suppliers and represents our current actual knowledge based on the information they provided. This information is subject to change. The part numbers that TE has identified as EU RoHS compliant have a maximum concentration of 0.1% by weight in homogenous materials for lead, hexavalent chromium, mercury, PBB, PBDE, DBP, BBP, DEHP, DIBP, and 0.01% for cadmium, or qualify for an exemption to these limits as defined in the Annexes of Directive 2011/65/EU (RoHS2). Finished electrical and electronic equipment products will be CE marked as required by Directive 2011/65/EU. Components may not be CE marked. Additionally, the part numbers that TE has identified as EU ELV compliant have a maximum concentration of 0.1% by weight in homogenous materials for lead, hexavalent chromium, and mercury, and 0.01% for cadmium, or qualify for an exemption to these limits as defined in the Annexes of Directive 2000/53/EC (ELV). Regarding the REACH Regulation, the information TE provides on SVHC in articles for this part number is based on the latest European Chemicals Agency (ECHA) 'Guidance on requirements for substances in articles' posted at this URL: <https://echa.europa.eu/guidance-documents/guidance-on-reach>

Compatible Parts





Also in the Series | Commercial MATE-N-LOK

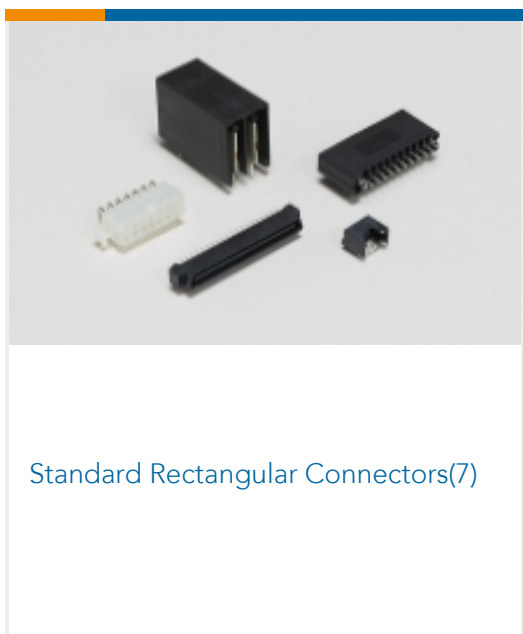
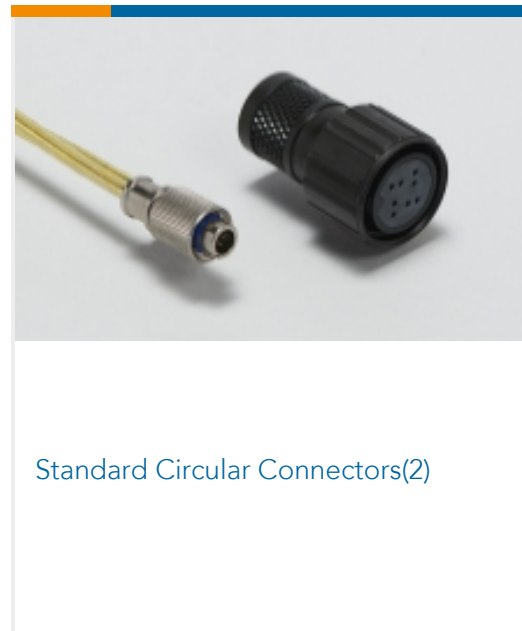
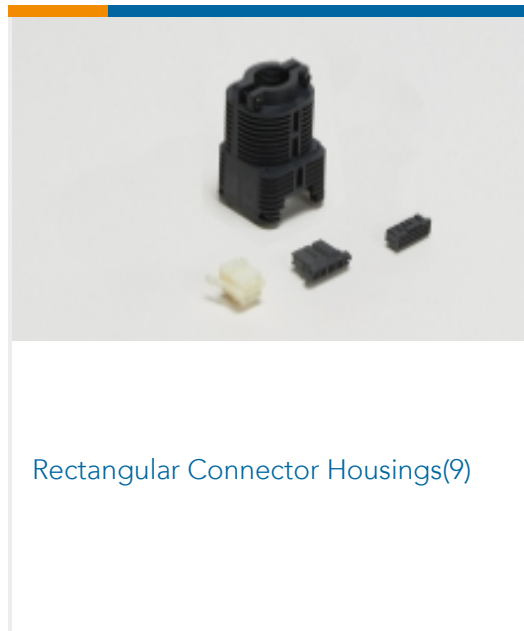
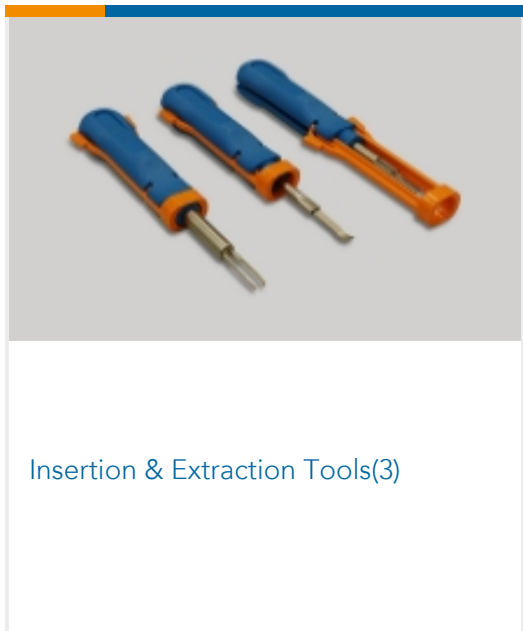
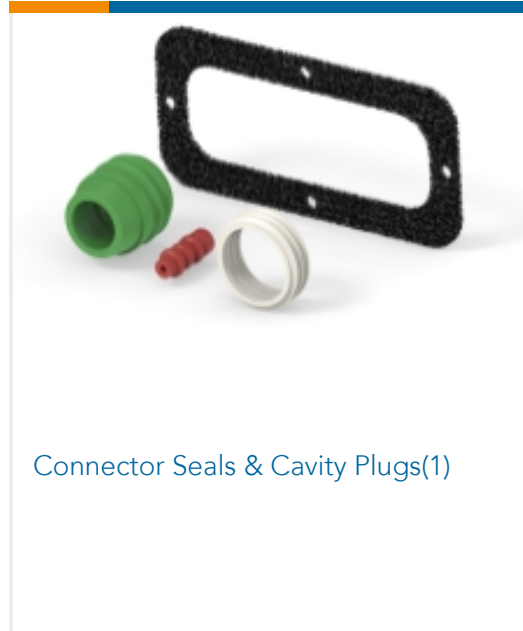
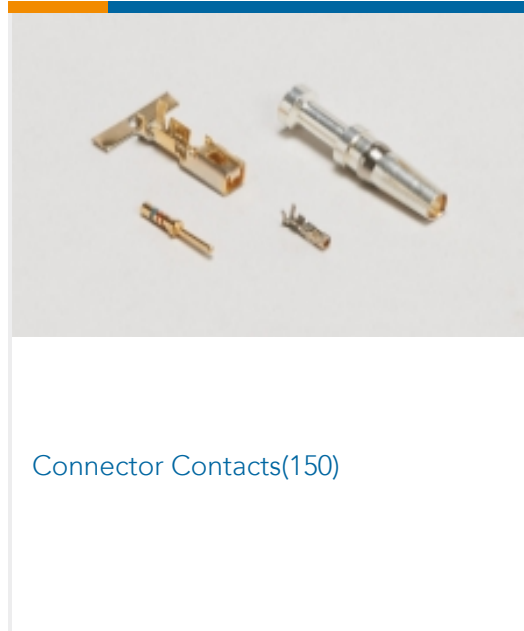
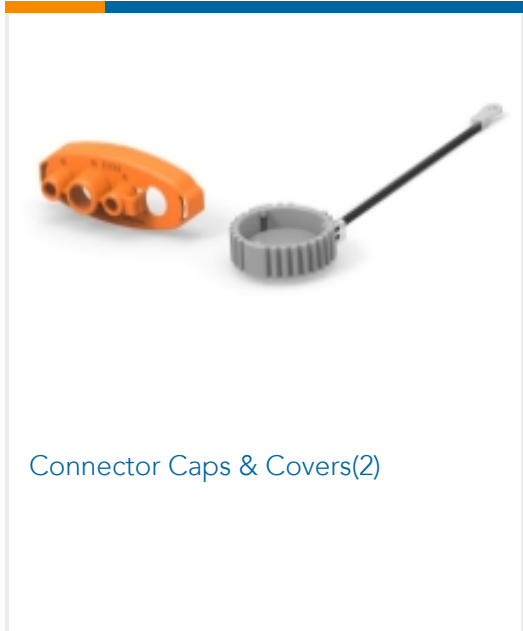

Customers Also Bought



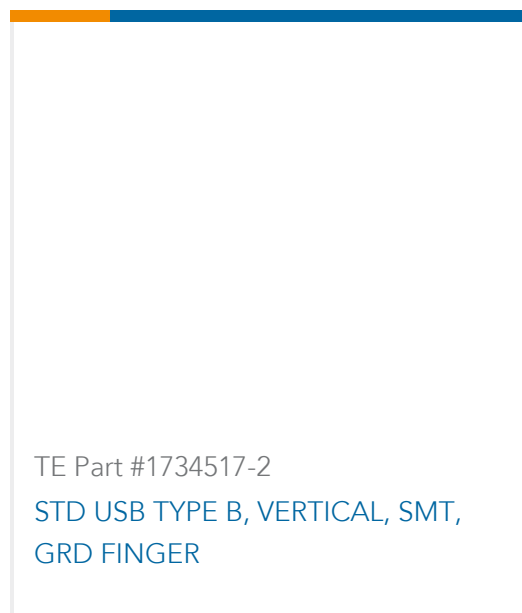
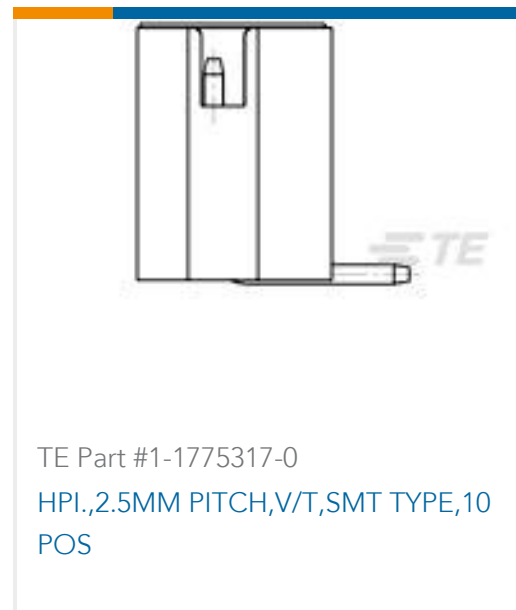

Documents

CAD Files

3D PDF

3D

Customer View Model

[ENG_CVM_CVM_61116-4_BL.2d_dxf.zip](#)

English

Customer View Model

[ENG_CVM_CVM_61116-4_BL.3d_igs.zip](#)

English

Customer View Model

[ENG_CVM_CVM_61116-4_BL.3d_stp.zip](#)

English

By downloading the CAD file I accept and agree to the [Terms and Conditions](#) of use.

Datasheets & Catalog Pages

[SOFT_SHELL_PIN_SOCKET_CONNECTORS_STANDARD_DENSITY](#)

English

Product Specifications

[Application Specification](#)

English