

181270-3 ✓ ACTIVE

AMPMODU | AMPMODU IV/V

TE Internal #: 181270-3

Socket Contact, Gold, 40 VAC, 60 VDC, 22 – 26 AWG Wire Size, .32
– .13 mm² Wire Size, 631.52 – 256.56 CMA Wire Size, Crimp,
AMPMODU IV/V

[View on TE.com >](#)



Connectors > Contacts > Connector Contacts

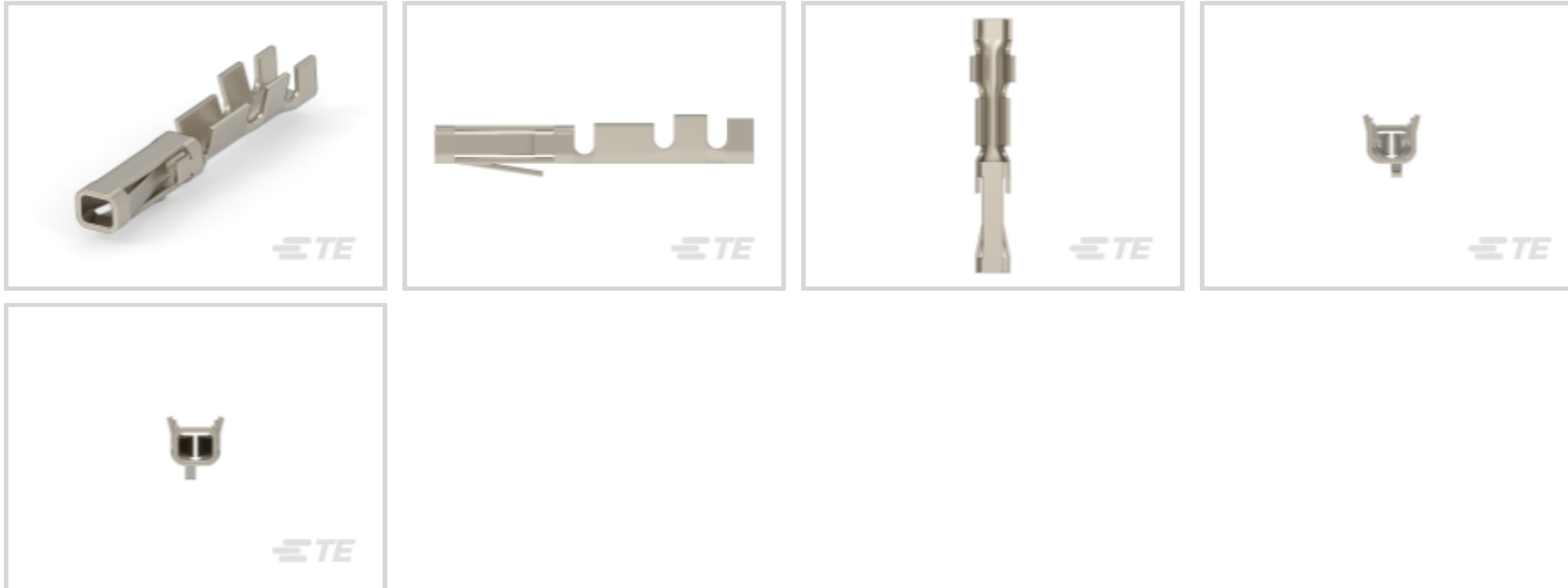

Contact Type: **Socket**

Contact Mating Area Plating Material: **Gold**

Wire Contact Termination Area Plating Material: **Gold Flash**

Operating Voltage: **60 VDC**

Features

Product Type Features

Applied Pressure	Standard
------------------	----------

Electrical Characteristics

Termination Resistance	7 mΩ
Operating Voltage	60 VDC

Contact Features

Mating Square Post Dimension	.63 mm[.025 in]
Contact Type	Socket
Contact Mating Area Plating Material	Gold
Wire Contact Termination Area Plating Material	Gold Flash
Contact Base Material	Phosphor Bronze
Contact Current Rating (Max)	3 A

Termination Features

Termination Method to Wire & Cable	Crimp
Product Terminates To	Printed Circuit Board



Mechanical Attachment

Wire Insulation Support	With
-------------------------	------

Dimensions

Compatible Insulation Diameter Range	.9 – 1.55 mm [.035 – .061 in]
Wire Size	631.52 – 256.56 CMA

Usage Conditions

Operating Temperature Range	-40 – 80 °C [-40 – 176 °F]
-----------------------------	----------------------------

Operation/Application

Circuit Application	Signal
---------------------	--------

Packaging Features

Packaging Method	Reel
------------------	------

Product Compliance

[For compliance documentation, visit the product page on TE.com>](#)

EU RoHS Directive 2011/65/EU	Compliant
EU ELV Directive 2000/53/EC	Compliant
China RoHS 2 Directive MIIT Order No 32, 2016	No Restricted Materials Above Threshold
EU REACH Regulation (EC) No. 1907/2006	Current ECHA Candidate List: JUNE 2023 (235) Candidate List Declared Against: JUNE 2023 (235) Does not contain REACH SVHC
Halogen Content	Low Halogen - Br, Cl, F, I < 900 ppm per homogenous material. Also BFR/CFR/PVC Free
Solder Process Capability	Not applicable for solder process capability

Product Compliance Disclaimer

This information is provided based on reasonable inquiry of our suppliers and represents our current actual knowledge based on the information they provided. This information is subject to change. The part numbers that TE has identified as EU RoHS compliant have a maximum concentration of 0.1% by weight in homogenous materials for lead, hexavalent chromium, mercury, PBB, PBDE, DBP, BBP, DEHP, DIBP, and 0.01% for cadmium, or qualify for an exemption to these limits as defined in the Annexes of Directive 2011/65/EU (RoHS2). Finished electrical and electronic equipment products will be CE marked as required by Directive 2011/65/EU. Components may not be CE marked. Additionally, the part numbers that TE has identified as EU ELV compliant have a maximum concentration of 0.1% by weight in homogenous materials for lead, hexavalent chromium, and mercury, and 0.01% for cadmium, or qualify for an exemption to these limits as defined in the Annexes of Directive 2000/53/EC (ELV). Regarding the REACH Regulation, the information TE provides on SVHC in articles for this part number is based on the latest European Chemicals Agency (ECHA) 'Guidance on requirements for substances in articles' posted at this URL: <https://echa.europa.eu/guidance-documents/guidance-on-reach>

Compatible Parts



TE Part # 58535-1
PRO-CRIMPER ASSY MODU MODII



TE Part # 280514
AMPMODU II REC. HSG, SINGLE ROW, 12 POS.



TE Part # 280366
AMPMODU II REC. HSG DUAL ROW, 16 POS.



TE Part # 280365
AMPMODU, DBL ROW, CONTACT REC



TE Part # 280361
AMPMODU II REC. HSG, SINGLE ROW 8 POS



TE Part # 280515
AMPMODU II REC. HSG, DUAL ROW, 24 POS.



TE Part # 280360
AMPMODU II REC. HSG, SINGLE ROW 6 POS



TE Part # 280513
AMPMODU II REC. HSG, DUAL ROW, 18 POS



TE Part # 280359
AMPMODU II REC. HSG, SINGLE ROW, 4 POS.



TE Part # 280368
AMPMODU II REC. HSG, DUAL ROW, 30 POS.



TE Part # 280363
AMPMODU II REC. HSG, SINGLE ROW, 15 POS.



TE Part # 284123-1
AMPMODU II REC. HSG, DUAL ROW, 10 POS.



TE Part # 58654-1
PRO-CRIMP TL & DIE MOD II



TE Part # 280362
AMPMODU II REC. HSG, SINGLE ROW, 10 POS.



TE Part # 280358
AMPMODU II REC. HSG, SINGLE ROW 2 POS



TE Part # 280512
AMPMODU II REC. HSG, SINGLE ROW, 9 POS.



TE Part # 281018
AMPMODU II REC. HSG, DUAL ROW, 36 POS.

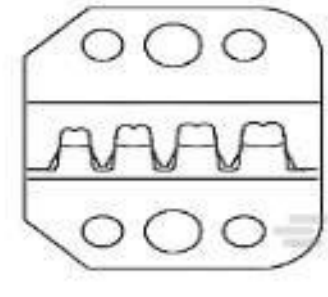

TE Part # 58535-2
PRO-CRIMPER ASSY MODU



TE Part # 280364
AMPMODU II COSI REC. HSG, SGL ROW, 22POS

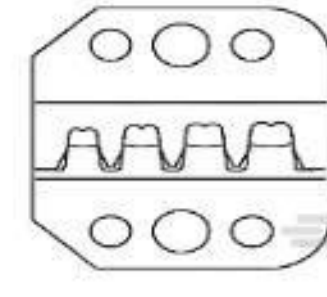

TE Part # 58654-2
PRO-CRIMPER DIE SET ONLY

Also in the Series | **AMPMODU IV/V**

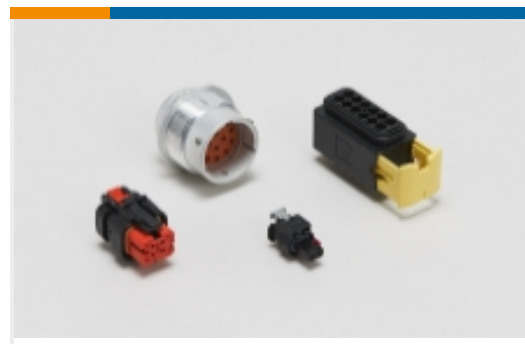

Automotive Housings(1)

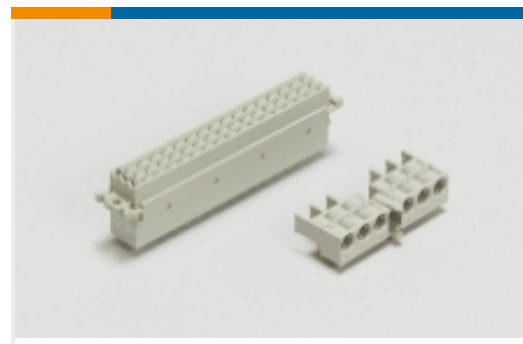

Backplane Connector Housings(1)



Connector Caps & Covers(18)

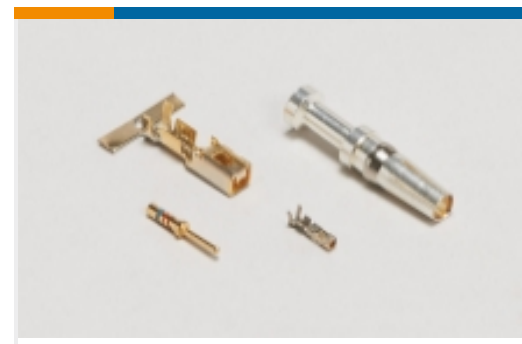

Connector Contacts(322)



Connector Hardware(13)



Connector Strain Relief(3)



Insertion & Extraction Tools(4)

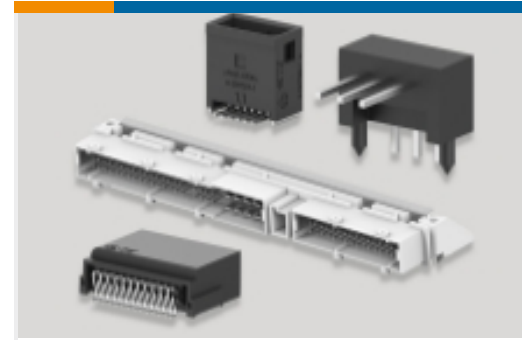

PCB Headers & Receptacles(931)



Rectangular Connector Housings(5)



Standard Rectangular Connectors(8)



Wire-to-Board Connector Assemblies & Housings(444)

Customers Also Bought



TE Part #316040-6
DYNAMIC D-5 REC CONT S L/P

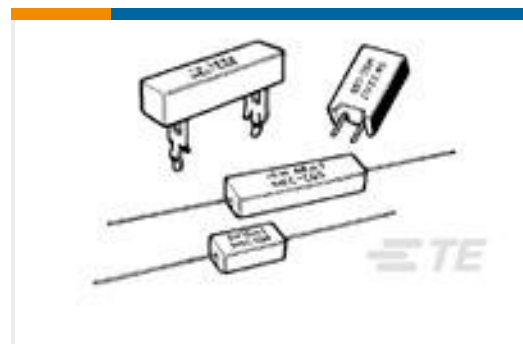

TE Part #1-1623788-2
SOM5 2R2 5% (WIRE)



TE Part #280361
AMPMODU II REC. HSG, SINGLE ROW 8 POS



TE Part #280359
AMPMODU II REC. HSG, SINGLE ROW, 4 POS.



TE Part #1658998-1
Mini DIN, 8 pos, R/A, Shield

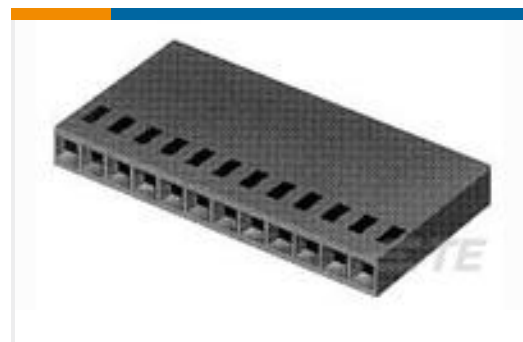

TE Part #2-87499-1
12 MODIV HSG SR MRKD .100CL

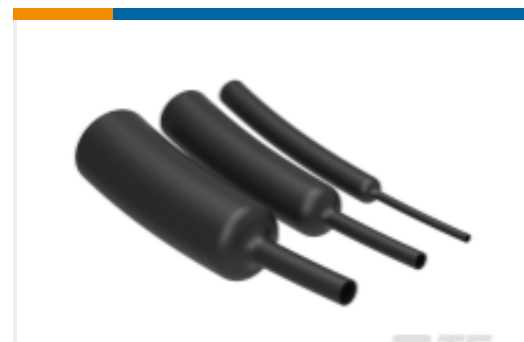

TE Part #7344214001
RNF-3000 Heat Shrink Tubing



TE Part #064004-E
SMCQ 50 M AB VW 3-04 * 2,8 0003 137 E001

Documents



Product Drawings

MOD 2 BUCHSE

English

CAD Files

3D PDF

3D

Customer View Model

[ENG_CVM_CVM_181270-3_AN_c-181270-3-an.2d_dxf.zip](#)

English

Customer View Model

[ENG_CVM_CVM_181270-3_AN_c-181270-3-an.3d_igs.zip](#)

English

Customer View Model

[ENG_CVM_CVM_181270-3_AN_c-181270-3-an.3d_stp.zip](#)

English

By downloading the CAD file I accept and agree to the [Terms and Conditions](#) of use.

Product Specifications

Application Specification

English