

176282-4 ✓ ACTIVE

AMP Universal Power

TE Internal #: 176282-4

Rectangular Power Connectors, Housing, Receptacle, Wire-to-Wire,
2 Position, 3.96 mm [.156 in] Centerline, Wire & Cable, UL 94V-0,
AMP Universal Power

[View on TE.com >](#)



Connectors > Power Connectors > Rectangular Power > Rectangular Power Connectors

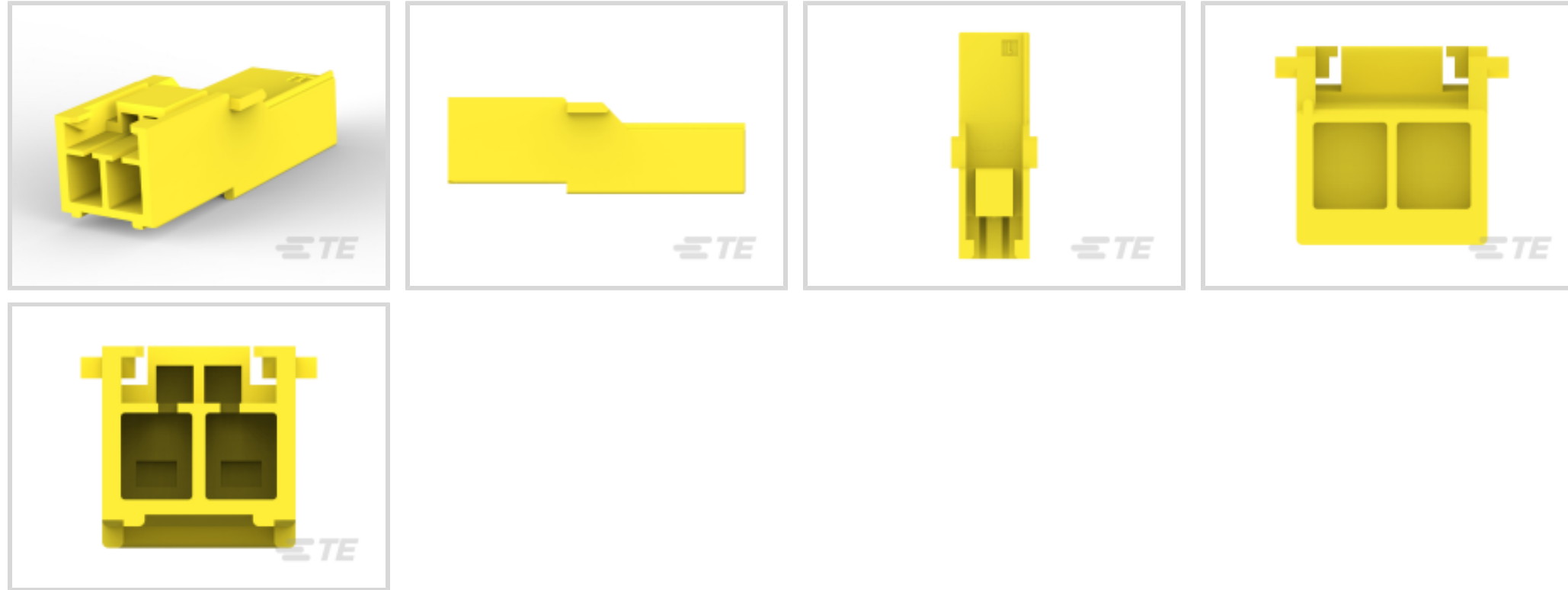

Rectangular Power Connector Type: **Housing**

Connector & Housing Type: **Receptacle**

Connector System: **Wire-to-Wire**

Number of Positions: **2**

Centerline (Pitch): **3.96 mm [.156 in]**

Features

Product Type Features

Rectangular Power Connector Type	Housing
Connector & Housing Type	Receptacle
Connector System	Wire-to-Wire
Sealable	No
Connector & Contact Terminates To	Wire & Cable

Configuration Features

Number of Positions	2
Number of Power Positions	0
Number of Signal Positions	0
Number of Rows	1

Electrical Characteristics

Operating Voltage	300 VAC
-------------------	---------

Contact Features

Contact Layout	Inline
----------------	--------



Contact Base Material	Copper Alloy
Contact Current Rating (Max)	7 A
Contact Retention Within Housing	Without
Contact Type	Tab

Termination Features

Termination Method to Wire & Cable	Crimp
------------------------------------	-------

Mechanical Attachment

Strain Relief	Without
Mating Alignment Type	Polarization
Mating Retention	With
Mating Alignment	With
Panel Mount Feature	Without
PCB Mount Retention	With
Mating Retention Type	Latch
Connector Mounting Type	Cable Mount (Free-Hanging)

Housing Features

Centerline (Pitch)	3.96 mm [.156 in]
Housing Color	Yellow
Housing Material	PA 6/6

Dimensions

Connector Height	8.4 mm [.33 in]
Product Length	29 mm [1.14 in]

Usage Conditions

Operating Temperature Range	-30 – 105 °C [-22 – 221 °F]
-----------------------------	-----------------------------

Operation/Application

Circuit Application	Power & Signal
---------------------	----------------

Industry Standards

UL Flammability Rating	UL 94V-0
Glow Wire Rating	Standard Part - Not Glow Wire

Packaging Features

Packaging Quantity	1000
--------------------	------



Packaging Method

Bag

Product Compliance

[For compliance documentation, visit the product page on TE.com>](#)

EU RoHS Directive 2011/65/EU	Compliant
EU ELV Directive 2000/53/EC	Compliant
China RoHS 2 Directive MIIT Order No 32, 2016	No Restricted Materials Above Threshold
EU REACH Regulation (EC) No. 1907/2006	Current ECHA Candidate List: JUNE 2023 (235) Candidate List Declared Against: JUNE 2023 (235) Does not contain REACH SVHC
Halogen Content	Low Halogen - Br, Cl, F, I < 900 ppm per homogenous material. Also BFR/CFR/PVC Free
Solder Process Capability	Not applicable for solder process capability

Product Compliance Disclaimer

This information is provided based on reasonable inquiry of our suppliers and represents our current actual knowledge based on the information they provided. This information is subject to change. The part numbers that TE has identified as EU RoHS compliant have a maximum concentration of 0.1% by weight in homogenous materials for lead, hexavalent chromium, mercury, PBB, PBDE, DBP, BBP, DEHP, DIBP, and 0.01% for cadmium, or qualify for an exemption to these limits as defined in the Annexes of Directive 2011/65/EU (RoHS2). Finished electrical and electronic equipment products will be CE marked as required by Directive 2011/65/EU. Components may not be CE marked. Additionally, the part numbers that TE has identified as EU ELV compliant have a maximum concentration of 0.1% by weight in homogenous materials for lead, hexavalent chromium, and mercury, and 0.01% for cadmium, or qualify for an exemption to these limits as defined in the Annexes of Directive 2000/53/EC (ELV). Regarding the REACH Regulation, the information TE provides on SVHC in articles for this part number is based on the latest European Chemicals Agency (ECHA) 'Guidance on requirements for substances in articles' posted at this URL: <https://echa.europa.eu/guidance-documents/guidance-on-reach>

Compatible Parts



TE Part # 175153-1
UNIV POWER TAB CONT L/P



TE Part # 175149-1
UNIVERSAL POWER CONN TAB



TE Part # 176271-1
AMP UNIVERSAL POWER PLUG 2P



TE Part # 175150-1
UNIVERSAL POWER CONN TAB

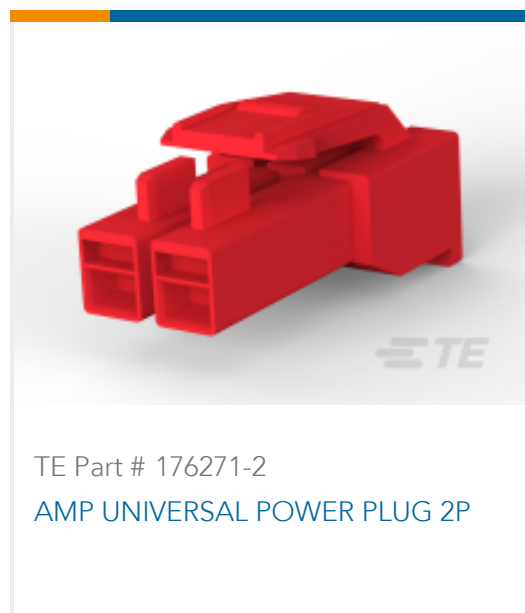
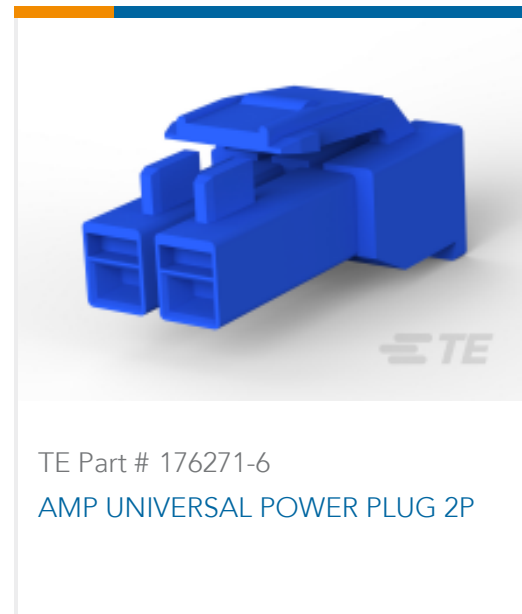
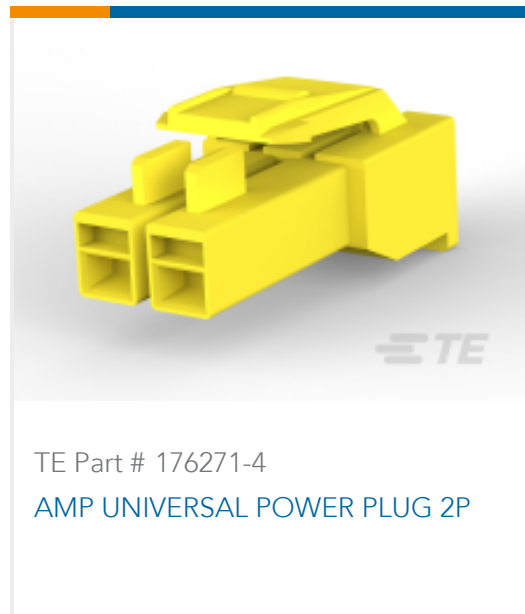

Also in the Series | AMP Universal Power

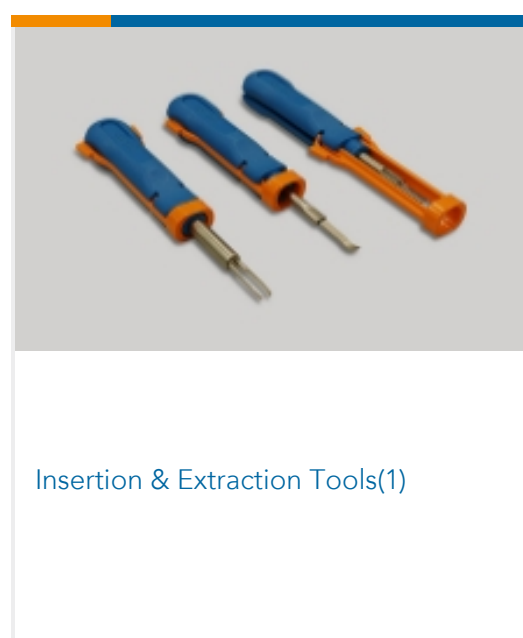
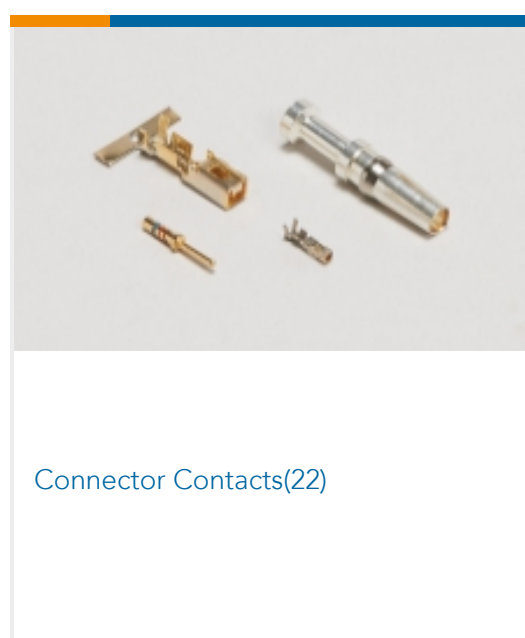

Customers Also Bought

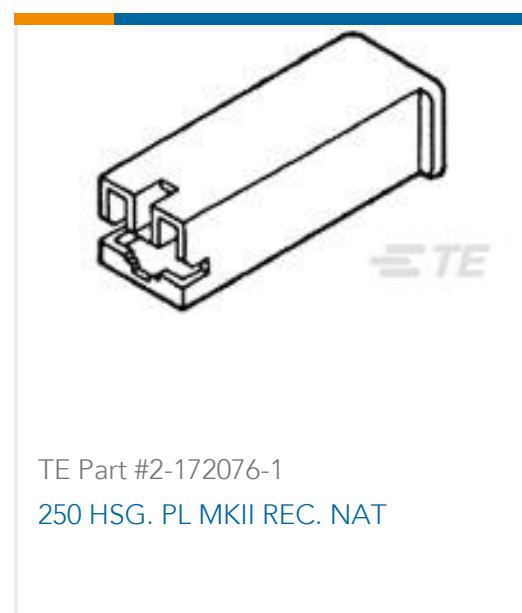



Documents

Product Drawings

[AMP UNIVERSAL POWER CAP 2P](#)

English

CAD Files

Customer View Model

[ENG_CVM_CVM_176282-4_L.2d_dxf.zip](#)

English

[3D PDF](#)

3D

Customer View Model

[ENG_CVM_CVM_176282-4_L.3d_igs.zip](#)

English

Customer View Model

[ENG_CVM_CVM_176282-4_L.3d_stp.zip](#)

English

By downloading the CAD file I accept and agree to the [Terms and Conditions](#) of use.

Product Specifications

[Crimping of Universal Power Contact](#)

English

[Product Specification](#)

Japanese

[AMP Universal Power Connector](#)

Japanese

Instruction Sheets

[AMP UNIVERSAL POWER CONNECTOR SERIES](#)

English

[Instruction Sheet \(non U.S.\)](#)

English

Agency Approvals

[UL Report](#)

English

176282-4

Rectangular Power Connectors, Housing, Receptacle, Wire-to-Wire, 2 Position, 3.96 mm [.156 in] Centerline, Wire & Cable, UL 94V-0, AMP Universal Power

