

Data sheet | Item number: 745-3254

PCB terminal block; 4 mm<sup>2</sup>; Pin spacing 12.5 mm; 4-pole; CAGE CLAMP®;  
4,00 mm<sup>2</sup>; gray

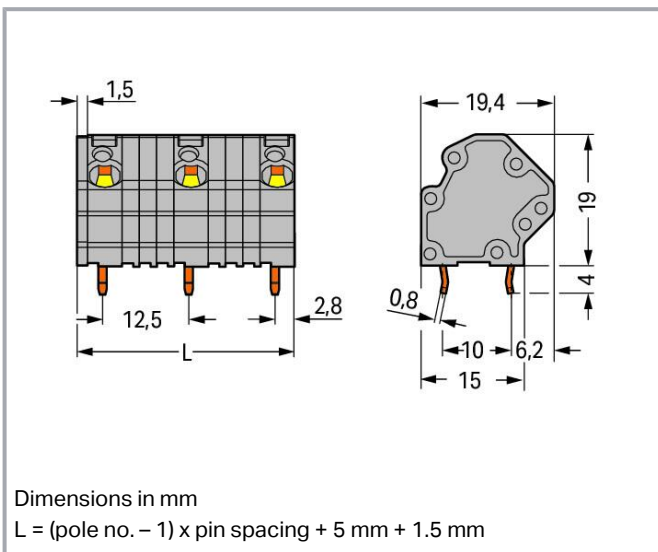

[www.wago.com/745-3254](http://www.wago.com/745-3254)

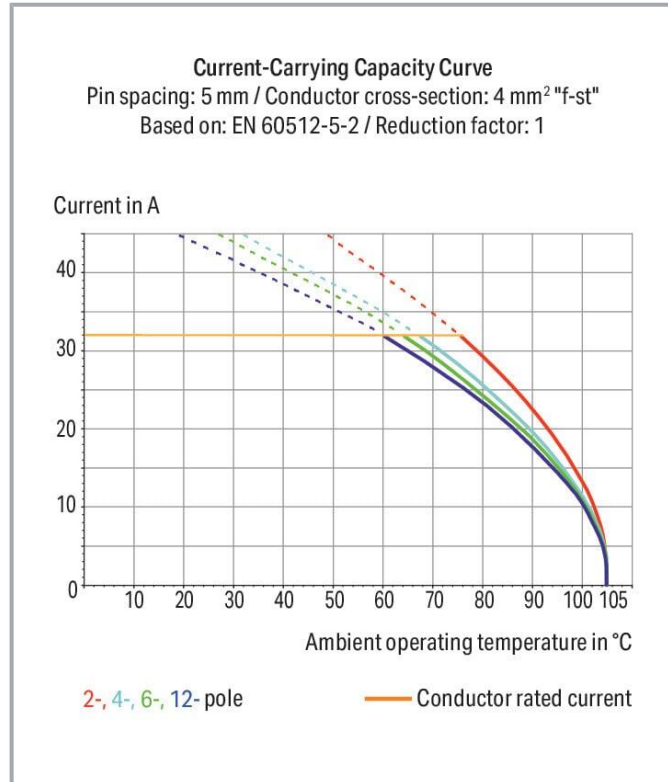
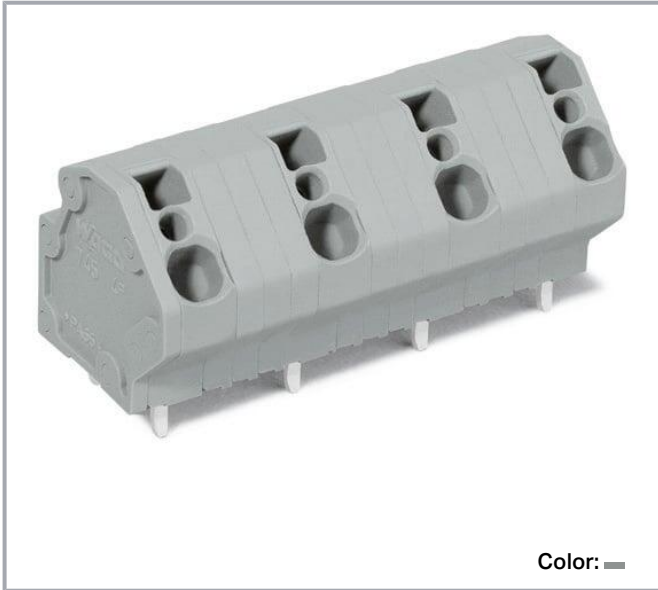

Subject to changes. Please also observe the further product documentation!

WAGO GmbH & Co. KG  
Hansastr. 27  
32423 Minden  
Phone: +49571 887-0 | Fax: +49571 887-169  
Email: [info.de@wago.com](mailto:info.de@wago.com) | Web: [www.wago.com](http://www.wago.com)

Do you have any questions about our products?  
We are always happy to take your call at +49 (571) 887-44222.



## Item description

- Terminal strips with screwdriver-actuated CAGE CLAMP® connection
- Versions with Ex approval
- Mixed-color PCB terminal strips from factory
- Space-saving configuration of terminal strips when placed behind each other
- Custom color combinations
- Double solder pins for high mechanical stability
- Integrated testing tap

## Data

### Notes

Variants:

Other pole numbers

Versions for Ex e II and Ex i

Versions for Ex i

Other colors

Mixed-color PCB connector strips

Direct marking

Other versions (or variants) can be requested from WAGO Sales or configured at <https://configurator.wago.com/>.

## Electrical data

### Ratings per IEC/EN

| Ratings per                   | IEC/EN 60664-1   |
|-------------------------------|--|
| Nominal voltage (III/3)       | 1000 V   |
| Rated impulse voltage (III/3) | 8 kV   |
| Rated voltage (III/2)         | 1000 V   |
| Rated impulse voltage (III/2) | 8 kV   |
| Nominal voltage (II/2)        | 1000 V   |
| Rated surge voltage (II/2)    | 8 kV   |
| Rated current                 | 32 A   |
| Legend (ratings)              | (III / 2) $\triangleq$ Overvoltage category III / Pollution degree 2 |

### Ratings per UL

| Approvals per                  | UL 1059 |
|--------------------------------|---------|
| Rated voltage UL (Use Group B) | 600 V   |
| Rated current UL (Use Group B) | 20 A    |

Subject to changes. Please also observe the further product documentation!

WAGO GmbH & Co. KG

Hansastr. 27

32423 Minden

Phone: +49571 887-0 | Fax: +49571 887-169

Email: [info.de@wago.com](mailto:info.de@wago.com) | Web: [www.wago.com](http://www.wago.com)

Do you have any questions about our products?

We are always happy to take your call at +49 (571) 887-44222.



|                                |       |
|--------------------------------|-------|
| Rated voltage UL (Use Group C) | 600 V |
| Rated current UL (Use Group C) | 20 A  |

### Ratings per CSA

|                                 |       |
|---------------------------------|-------|
| Approvals per                   | CSA   |
| Rated voltage CSA (Use Group B) | 600 V |
| Rated current CSA (Use Group B) | 20 A  |
| Rated voltage CSA (Use Group C) | 600 V |
| Rated current CSA (Use Group C) | 20 A  |

### Connection data

|                            |   |
|----------------------------|---|
| Connection points          | 4 |
| Total number of potentials | 4 |
| Number of connection types | 1 |
| Number of levels           | 1 |

### Connection 1

|   |  |
|---|--|
| Connection technology                             | CAGE CLAMP®                                |
| Actuation type                                    | Operating tool                             |
| Solid conductor                                   | 0.08 ... 4 mm <sup>2</sup> / 28 ... 12 AWG |
| Fine-stranded conductor                           | 0.08 ... 4 mm <sup>2</sup> / 28 ... 12 AWG |
| Fine-stranded conductor; with insulated ferrule   | 0.25 ... 2.5 mm <sup>2</sup>               |
| Fine-stranded conductor; with uninsulated ferrule | 0.25 ... 2.5 mm <sup>2</sup>               |
| Strip length                                      | 8 ... 9 mm / 0.31 ... 0.35 inches          |
| Conductor connection direction to PCB             | 45 °                                       |
| Pole number                                       | 4  |

### Physical data

|                                      |                          |
|--------------------------------------|--------------------------|
| Pin spacing                          | 12.5 mm / 0.492 inches   |
| Width                                | 44 mm / 1.732 inches     |
| Height                               | 23 mm / 0.906 inches     |
| Height from the surface              | 19 mm / 0.748 inches     |
| Depth                                | 19.4 mm / 0.764 inches   |
| Solder pin length                    | 4 mm                     |
| Solder pin dimensions                | 0.8 x 1.2 mm             |
| Drilled hole diameter with tolerance | 1.5 <sup>(+0.1)</sup> mm |

Subject to changes. Please also observe the further product documentation!



## PCB contact

|                                     |  |
|-------------------------------------|--|
| PCB contact                         | THT                                      |
| Solder pin arrangement              | over the entire terminal strip (in-line) |
| Number of solder pins per potential | 2  |

## Material data

|                             |  |
|-----------------------------|--|
| Note (material data)        | Information on material specifications can be found here |
| Color                       | gray   |
| Material group              | I  |
| Insulation material         | Polyamide (PA66)   |
| Flammability class per UL94 | V0   |
| Clamping spring material    | Chrome-nickel spring steel (CrNi)                        |
| Contact material            | Electrolytic copper (E <sub>Cu</sub> )                   |
| Contact plating             | Tin  |
| Fire load                   | 0.24 MJ  |
| Weight                      | 11.7 g   |

## Environmental requirements

|                         |                 |
|-------------------------|-----------------|
| Limit temperature range | -60 ... +105 °C |
|-------------------------|-----------------|

## Commercial data

|                       |                                |
|-----------------------|--------------------------------|
| Product Group         | 4 (Printed Circuit Connectors) |
| eCl@ss 10.0           | 27-44-04-01                    |
| eCl@ss 9.0            | 27-44-04-01                    |
| ETIM 8.0              | EC002643                       |
| ETIM 7.0              | EC002643                       |
| ECCN                  | NO DATA                        |
| PU (SPU)              | 72 pcs                         |
| Packaging type        | box                            |
| Country of origin     | PL                             |
| GTIN                  | 4045454001094                  |
| Customs tariff number | 85369010000                    |

Subject to changes. Please also observe the further product documentation!





## Environmental Product Compliance

RoHS Compliance Status



Compliant, No Exemption

## Approvals / Certificates

### General approvals

| Logo   | Approval                                | Additional Approval Text | Certificate name |
|--|---|--------------------------|------------------|
|    | CCA<br>DEKRA Certification B.V.         | EN 60947                 | NTR NL-7095      |
|    | CCA<br>DEKRA Certification B.V.         | EN 60947                 | 71-112275        |
|    | CSA<br>DEKRA Certification B.V.         | C22.2 No. 158            | 1604421          |
|  | cURus<br>Underwriters Laboratories Inc. | UL 1059                  | E45172           |

### Declarations of conformity and manufacturer's declarations

| Logo   | Approval   | Additional Approval Text | Certificate name |
|--|--|--------------------------|------------------|
|  | EU-Declaration of Conformity<br>WAGO GmbH & Co. KG | -                        | -                |
|  | UK-Declaration of Conformity<br>WAGO GmbH & Co. KG | -                        | -                |

## Optional accessories

### Testing and measuring

Testing accessories

Subject to changes. Please also observe the further product documentation!













WAGO GmbH & Co. KG  
 Hansastr. 27  
 32423 Minden  
 Phone: +49571 887-0 | Fax: +49571 887-169  
 Email: [info.de@wago.com](mailto:info.de@wago.com) | Web: [www.wago.com](http://www.wago.com)

Do you have any questions about our products?  
 We are always happy to take your call at +49 (571) 887-44222.

**Item no.: 210-136**

Test plug; 2 mm Ø; with 500 mm cable; red

[www.wago.com/210-136](http://www.wago.com/210-136)**Ferrule**

| Ferrule   |   |  |
|---|---|--|
|    | <b>Item no.: 216-106</b><br>Ferrule; Sleeve for 2.5 mm <sup>2</sup> / AWG 14; uninsulated; electro-tin plated; silver-colored   | <a href="http://www.wago.com/216-106">www.wago.com/216-106</a> |
|    | <b>Item no.: 216-123</b><br>Ferrule; Sleeve for 1 mm <sup>2</sup> / AWG 18; uninsulated; electro-tin plated; silver-colored   | <a href="http://www.wago.com/216-123">www.wago.com/216-123</a> |
|    | <b>Item no.: 216-122</b><br>Ferrule; Sleeve for 0.75 mm <sup>2</sup> / AWG 20; uninsulated; electro-tin plated; silver-colored  | <a href="http://www.wago.com/216-122">www.wago.com/216-122</a> |
|    | <b>Item no.: 216-124</b><br>Ferrule; Sleeve for 1.5 mm <sup>2</sup> / AWG 16; uninsulated; electro-tin plated   | <a href="http://www.wago.com/216-124">www.wago.com/216-124</a> |
|    | <b>Item no.: 216-142</b><br>Ferrule; Sleeve for 0.75 mm <sup>2</sup> / 18 AWG; uninsulated; electro-tin plated; electrolytic copper; gastight crimped; acc. to DIN 46228, Part 1/08.92                | <a href="http://www.wago.com/216-142">www.wago.com/216-142</a> |
|    | <b>Item no.: 216-132</b><br>Ferrule; Sleeve for 0.34 mm <sup>2</sup> / AWG 24; uninsulated; electro-tin plated  | <a href="http://www.wago.com/216-132">www.wago.com/216-132</a> |
|    | <b>Item no.: 216-121</b><br>Ferrule; Sleeve for 0.5 mm <sup>2</sup> / AWG 22; uninsulated; electro-tin plated; silver-colored   | <a href="http://www.wago.com/216-121">www.wago.com/216-121</a> |
|  | <b>Item no.: 216-143</b><br>Ferrule; Sleeve for 1 mm <sup>2</sup> / AWG 18; uninsulated; electro-tin plated; electrolytic copper; gastight crimped; acc. to DIN 46228, Part 1/08.92                   | <a href="http://www.wago.com/216-143">www.wago.com/216-143</a> |
|  | <b>Item no.: 216-131</b><br>Ferrule; Sleeve for 0.25 mm <sup>2</sup> / AWG 24; uninsulated; electro-tin plated; silver-colored  | <a href="http://www.wago.com/216-131">www.wago.com/216-131</a> |
|  | <b>Item no.: 216-141</b><br>Ferrule; Sleeve for 0.5 mm <sup>2</sup> / 20 AWG; uninsulated; electro-tin plated; electrolytic copper; gastight crimped; acc. to DIN 46228, Part 1/08.92                 | <a href="http://www.wago.com/216-141">www.wago.com/216-141</a> |
|  | <b>Item no.: 216-152</b><br>Ferrule; Sleeve for 0.34 mm <sup>2</sup> / AWG 24; uninsulated; electro-tin plated  | <a href="http://www.wago.com/216-152">www.wago.com/216-152</a> |
|  | <b>Item no.: 216-151</b><br>Ferrule; Sleeve for 0.25 mm <sup>2</sup> / AWG 24; uninsulated; electro-tin plated  | <a href="http://www.wago.com/216-151">www.wago.com/216-151</a> |
|  | <b>Item no.: 216-144</b><br>Ferrule; Sleeve for 1.5 mm <sup>2</sup> / AWG 16; uninsulated; electro-tin plated; electrolytic copper; gastight crimped; acc. to DIN 46228, Part 1/08.92; silver-colored | <a href="http://www.wago.com/216-144">www.wago.com/216-144</a> |
|  | <b>Item no.: 216-223</b><br>Ferrule; Sleeve for 1 mm <sup>2</sup> / AWG 18; insulated; electro-tin plated; red  | <a href="http://www.wago.com/216-223">www.wago.com/216-223</a> |
|  | <b>Item no.: 216-241</b><br>Ferrule; Sleeve for 0.5 mm <sup>2</sup> / 20 AWG; insulated; electro-tin plated; electrolytic copper; gastight crimped; acc. to DIN 46228, Part 4/09.90; white            | <a href="http://www.wago.com/216-241">www.wago.com/216-241</a> |

Subject to changes. Please also observe the further product documentation!

WAGO GmbH &amp; Co. KG

Hansastr. 27















32423 Minden

Phone: +49571 887-0 | Fax: +49571 887-169

Email: [info.de@wago.com](mailto:info.de@wago.com) | Web: [www.wago.com](http://www.wago.com)

Do you have any questions about our products?

We are always happy to take your call at +49 (571) 887-44222.

|   |  |  |
|---|--|--|
|    | <b>Item no.: 216-242</b><br>Ferrule; Sleeve for 0.75 mm <sup>2</sup> / 18 AWG; insulated; electro-tin plated; electrolytic copper; gastight crimped; acc. to DIN 46228, Part 4/09.90; gray | <a href="http://www.wago.com/216-242">www.wago.com/216-242</a> |
|    | <b>Item no.: 216-222</b><br>Ferrule; Sleeve for 0.75 mm <sup>2</sup> / 18 AWG; insulated; electro-tin plated; gray   | <a href="http://www.wago.com/216-222">www.wago.com/216-222</a> |
|    | <b>Item no.: 216-221</b><br>Ferrule; Sleeve for 0.5 mm <sup>2</sup> / 20 AWG; insulated; electro-tin plated; white   | <a href="http://www.wago.com/216-221">www.wago.com/216-221</a> |
|    | <b>Item no.: 216-224</b><br>Ferrule; Sleeve for 1.5 mm <sup>2</sup> / AWG 16; insulated; electro-tin plated; black   | <a href="http://www.wago.com/216-224">www.wago.com/216-224</a> |
|    | <b>Item no.: 216-243</b><br>Ferrule; Sleeve for 1 mm <sup>2</sup> / AWG 18; insulated; electro-tin plated; electrolytic copper; gastight crimped; acc. to DIN 46228, Part 4/09.90; red     | <a href="http://www.wago.com/216-243">www.wago.com/216-243</a> |
|    | <b>Item no.: 216-244</b><br>Ferrule; Sleeve for 1.5 mm <sup>2</sup> / AWG 16; insulated; electro-tin plated; electrolytic copper; gastight crimped; acc. to DIN 46228, Part 4/09.90; black | <a href="http://www.wago.com/216-244">www.wago.com/216-244</a> |
|    | <b>Item no.: 216-263</b><br>Ferrule; Sleeve for 1 mm <sup>2</sup> / AWG 18; insulated; electro-tin plated; electrolytic copper; gastight crimped; acc. to DIN 46228, Part 4/09.90; red     | <a href="http://www.wago.com/216-263">www.wago.com/216-263</a> |
|    | <b>Item no.: 216-246</b><br>Ferrule; Sleeve for 2.5 mm <sup>2</sup> / AWG 14; insulated; electro-tin plated; electrolytic copper; gastight crimped; acc. to DIN 46228, Part 4/09.90; blue  | <a href="http://www.wago.com/216-246">www.wago.com/216-246</a> |
|   | <b>Item no.: 216-266</b><br>Ferrule; Sleeve for 2.5 mm <sup>2</sup> / AWG 14; insulated; electro-tin plated; electrolytic copper; gastight crimped; acc. to DIN 46228, Part 4/09.90; blue  | <a href="http://www.wago.com/216-266">www.wago.com/216-266</a> |
|  | <b>Item no.: 216-264</b><br>Ferrule; Sleeve for 1.5 mm <sup>2</sup> / AWG 16; insulated; electro-tin plated; electrolytic copper; gastight crimped; acc. to DIN 46228, Part 4/09.90; black | <a href="http://www.wago.com/216-264">www.wago.com/216-264</a> |
|  | <b>Item no.: 216-286</b><br>Ferrule; Sleeve for 2.5 mm <sup>2</sup> / AWG 14; insulated; electro-tin plated; electrolytic copper; gastight crimped; acc. to DIN 46228, Part 4/09.90; blue  | <a href="http://www.wago.com/216-286">www.wago.com/216-286</a> |
|  | <b>Item no.: 216-262</b><br>Ferrule; Sleeve for 0.75 mm <sup>2</sup> / 18 AWG; insulated; electro-tin plated; electrolytic copper; gastight crimped; acc. to DIN 46228, Part 4/09.90; gray | <a href="http://www.wago.com/216-262">www.wago.com/216-262</a> |
|  | <b>Item no.: 216-321</b><br>Ferrule; Sleeve for 0.25 mm <sup>2</sup> / AWG 24; insulated; electro-tin plated; yellow   | <a href="http://www.wago.com/216-321">www.wago.com/216-321</a> |
|  | <b>Item no.: 216-322</b><br>Ferrule; Sleeve for 0.34 mm <sup>2</sup> / 22 AWG; insulated; electro-tin plated; light turquoise  | <a href="http://www.wago.com/216-322">www.wago.com/216-322</a> |
| <b>Tool</b>   |  |  |
| Operating tool  |  |  |
|  | <b>Item no.: 210-657</b><br>Operating tool; Blade: 3.5 x 0.5 mm; with a partially insulated shaft; short; multicoloured  | <a href="http://www.wago.com/210-657">www.wago.com/210-657</a> |

Subject to changes. Please also observe the further product documentation!



Item no.: 210-658

Operating tool; Blade: 3.5 x 0.5 mm; with a partially insulated shaft; angled; short; multicoloured

[www.wago.com/210-658](http://www.wago.com/210-658)



Item no.: 210-720

Operating tool; Blade: 3.5 x 0.5 mm; with a partially insulated shaft; multicoloured

[www.wago.com/210-720](http://www.wago.com/210-720)

## Downloads

### Documentation

#### Additional Information

|                        |            |        |          |
|------------------------|------------|--------|----------|
| Technical Section      | 2019 Apr 3 | pdf    | Download |
| Technical explanations |            | 2.1 MB |          |

## CAD/CAE-Data

### CAD data

|                       |     |          |
|-----------------------|-----|----------|
| 2D/3D Models 745-3254 | URL | Download |
|-----------------------|-----|----------|

### CAE data

|                            |     |          |
|----------------------------|-----|----------|
| EPLAN Data Portal 745-3254 | URL | Download |
|----------------------------|-----|----------|

|                       |     |          |
|-----------------------|-----|----------|
| ZUKEN Portal 745-3254 | URL | Download |
|-----------------------|-----|----------|

### PCB Design

|   |     |          |
|---|-----|----------|
| Symbol and Footprint via Ultra Librarian 745-3254 | URL | Download |
|---|-----|----------|

CAX data for your PCB design, consisting of "schematic symbols and PCB footprints", allow easy integration of the WAGO component into your development environment.

#### Supported formats:

- Accel EDA 14 & 15
- Altair
- Altium 6 to current version
- Autodesk Fusion 360
- Cadence Allegro
- DesignSpark

Subject to changes. Please also observe the further product documentation!





- Eagle Libraries
- KiCad
- Mentor Graphics
- BoardStation
- Mentor Graphics Design Architect
- Mentor Graphics Design
- Expedition 99 and 2000
- OrCAD 9.X PCB and Capture
- PADS PowerPCB 3, 3.5, 4.X, and 5.X
- PADS PowerPCB and PowerLogic 3.0
- PCAD 2000, 2001, 2002, 2004, and 2006
- Pulsonix 8.5 or newer
- STL
- 3D STEP
- TARGET 3001!
- View Logic ViewDraw
- Quadcept
- Zuken CadStar 3 and 4
- Zuken CR-5000 and CR-8000
- Zuken eCADSTAR 2020 and 2021 Zuken CR-5000 and CR-8000

PCB Component Libraries (EDA), PCB CAD Library Ultra Librarian

---

Symbol and Footprint via SamacSys 745-3254

[URL](#)

[Download](#)

CAx data for your PCB design, consisting of "schematic symbols and PCB footprints", allow easy integration of the WAGO component into your development environment.

Supported formats:

- 3D (stp)
- Altium
- CADSTAR
- Capture
- CircuitStudio
- CR-5000
- CR-8000
- DEHDL
- DesignSpark PCB
- DesignSpark PCB PRO

—  
Subject to changes. Please also observe the further product documentation!

---

WAGO GmbH & Co. KG

Hansastr. 27

32423 Minden

Phone: +49571 887-0 | Fax: +49571 887-169

Email: [info.de@wago.com](mailto:info.de@wago.com) | Web: [www.wago.com](http://www.wago.com)

Do you have any questions about our products?

We are always happy to take your call at +49 (571) 887-44222.



- DipTrace
- EAGLE
- Easy-PC
- EasyEDA
- eCADSTAR
- KiCad
- OrCAD\_Allegro16
- PADS
- Proteus
- Pulsonix
- Quadcept
- SOLIDWORKS PCB
- TARGET 3001!
- xDX Designer
- Xpedition

PCB Component Libraries (EDA), PCB CAD Library SamacSys Electronic Component Search Engine

---

#### Asset Administration Shell

|                                     |                     |                          |
|-------------------------------------|---------------------|--------------------------|
| Asset Administration Shell 745-3254 | <a href="#">URL</a> | <a href="#">Download</a> |
|-------------------------------------|---------------------|--------------------------|

---

#### Environmental Product Compliance

##### Compliance Search

|  |                     |                          |
|--|---------------------|--------------------------|
| Environmental Product Compliance 745-3254<br>PCB terminal block; 4 mm <sup>2</sup> ; Pin spacing 12.5 mm; 4-pole; CAGE CLAMP®; 4,00 mm <sup>2</sup> ; gray | <a href="#">URL</a> | <a href="#">Download</a> |
|--|---------------------|--------------------------|

---

#### Installation Notes

##### Conductor termination

Subject to changes. Please also observe the further product documentation!

---

WAGO GmbH & Co. KG  
Hansastr. 27  
32423 Minden  
Phone: +49571 887-0 | Fax: +49571 887-169  
Email: [info.de@wago.com](mailto:info.de@wago.com) | Web: [www.wago.com](http://www.wago.com)

Do you have any questions about our products?  
We are always happy to take your call at +49 (571) 887-44222.

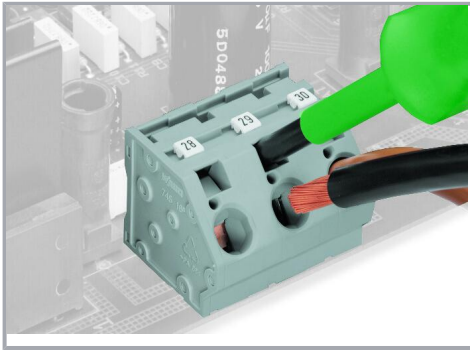

Inserting/removing a conductor via 5.5 mm screwdriver – 745 Series, 16 mm<sup>2</sup>.

### Marking



Marking via Mini-WSB and WMB markers or factory direct marking – 745 Series.

### Testing

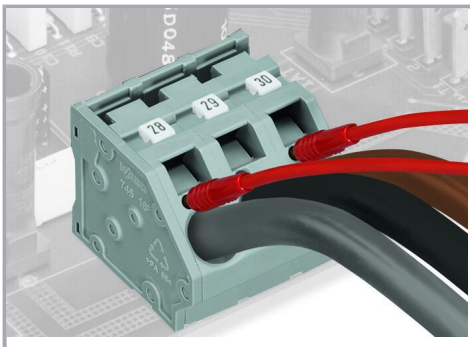

Testing with test plug – 745 Series.

Subject to changes. Please also observe the further product documentation!