

Data sheet | Item number: 745-1404

PCB terminal block; 6 mm²; Pin spacing 12.5 mm; 4-pole; CAGE CLAMP®; commoning option; 6,00 mm²; gray

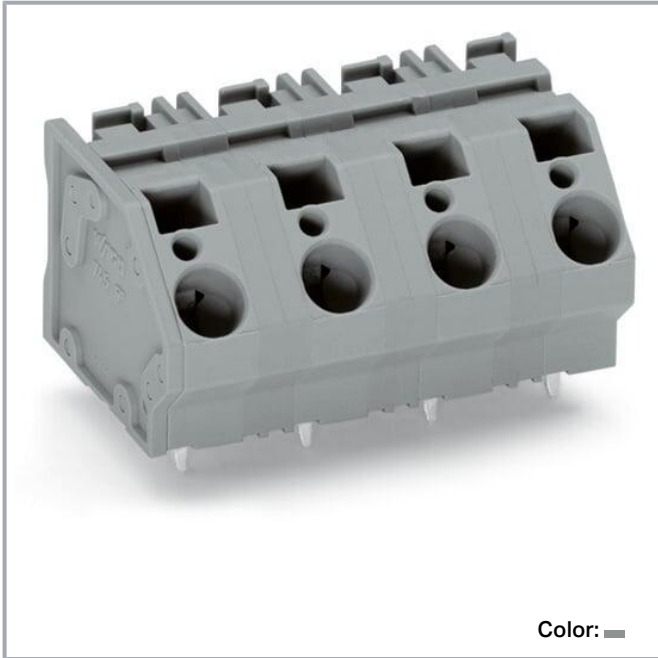

www.wago.com/745-1404



Color: ■

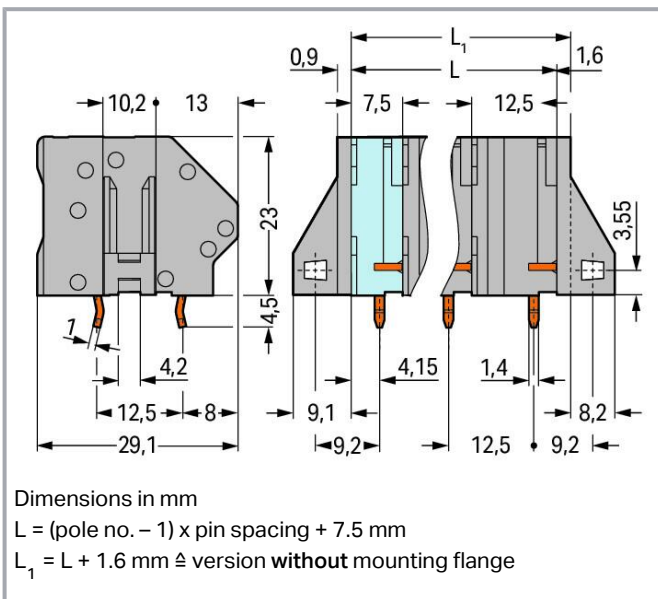
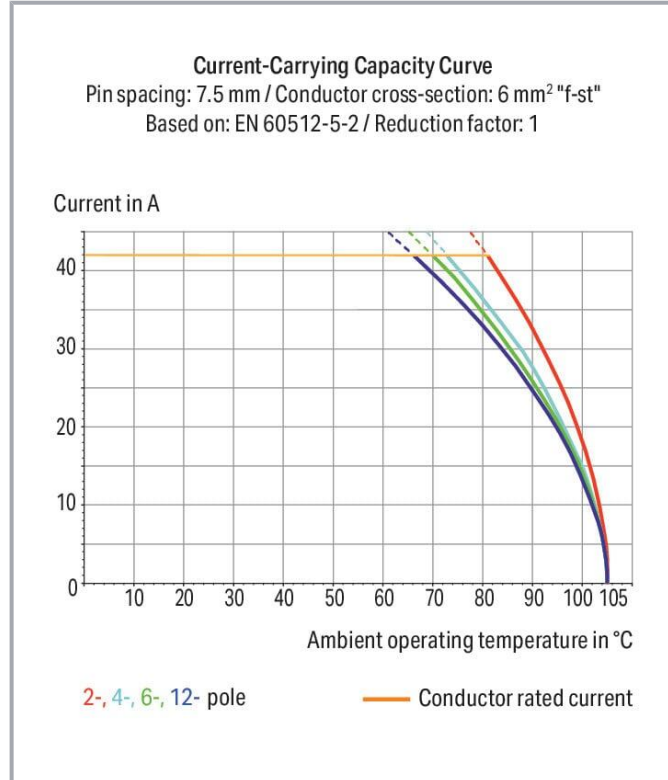

Subject to changes. Please also observe the further product documentation!

WAGO GmbH & Co. KG
 Hansastr. 27
 32423 Minden
 Phone: +49571 887-0 | Fax: +49571 887-169
 Email: info.de@wago.com | Web: www.wago.com

Do you have any questions about our products?
 We are always happy to take your call at +49 (571) 887-44222.



Item description

- Terminal strips with screwdriver-actuated CAGE CLAMP® connection
- Versions with Ex approval
- Unrestricted UL approval up to 600 V with 12.5 mm pin spacing
- Double solder pins for high mechanical stability
- Custom color combinations
- Integrated testing tap
- Marker slot for Mini-WSB and WMB markers

Data

Notes

Variants:

Other pole numbers

Versions for Ex e II and Ex i

Other colors

Mixed-color PCB connector strips

Versions with mounting flanges

Direct marking

Other versions (or variants) can be requested from WAGO Sales or configured at <https://configurator.wago.com/>.

Electrical data

Ratings per IEC/EN

Ratings per	IEC/EN 60664-1
Nominal voltage (III/3)	1000 V
Rated impulse voltage (III/3)	8 kV
Rated voltage (III/2)	1000 V
Rated impulse voltage (III/2)	8 kV
Nominal voltage (II/2)	1000 V
Rated surge voltage (II/2)	8 kV
Rated current	41 A
Legend (ratings)	(III / 2) ≙ Overvoltage category III / Pollution degree 2

Ratings per UL

Approvals per	UL 1059
Rated voltage UL (Use Group B)	600 V

Subject to changes. Please also observe the further product documentation!

WAGO GmbH & Co. KG

Hansastr. 27

32423 Minden

Phone: +49571 887-0 | Fax: +49571 887-169

Email: info.de@wago.com | Web: www.wago.com

Do you have any questions about our products?

We are always happy to take your call at +49 (571) 887-44222.



Rated current UL (Use Group B)	30 A
Rated voltage UL (Use Group C)	600 V
Rated current UL (Use Group C)	30 A

Ratings per CSA

Approvals per	CSA
Rated voltage CSA (Use Group B)	600 V
Rated current CSA (Use Group B)	30 A
Rated voltage CSA (Use Group C)	600 V
Rated current CSA (Use Group C)	30 A

Connection data

Connection points	4
Total number of potentials	4
Number of connection types	1
Number of levels	1

Connection 1

Connection technology	CAGE CLAMP®
Actuation type	Operating tool
Solid conductor	0.2 ... 6 mm ² / 24 ... 10 AWG
Fine-stranded conductor	0.2 ... 6 mm ² / 24 ... 10 AWG
Fine-stranded conductor; with insulated ferrule	0.25 ... 4 mm ²
Fine-stranded conductor; with uninsulated ferrule	0.25 ... 4 mm ²
Strip length	11 ... 12 mm / 0.43 ... 0.47 inches
Conductor connection direction to PCB	45 °
Pole number	4

Physical data

Pin spacing	12.5 mm / 0.492 inches
Width	46.6 mm / 1.835 inches
Height	27.5 mm / 1.083 inches
Height from the surface	23 mm / 0.906 inches
Depth	29.1 mm / 1.146 inches
Solder pin length	4.5 mm
Solder pin dimensions	1 x 1.4 mm

Subject to changes. Please also observe the further product documentation!



Drilled hole diameter with tolerance	1.8 ^(+0.1) mm
--------------------------------------	--------------------------

PCB contact

PCB contact	THT
Solder pin arrangement	over the entire terminal strip (in-line)
Number of solder pins per potential	2

Material data

Note (material data)	Information on material specifications can be found here
----------------------	--

Color	gray
Material group	I
Insulation material	Polyamide (PA66)
Flammability class per UL94	V0
Clamping spring material	Chrome-nickel spring steel (CrNi)
Contact material	Electrolytic copper (E _{Cu})
Contact plating	Tin
Fire load	0.475 MJ
Weight	24.9 g

Environmental requirements

Limit temperature range	-60 ... +105 °C
-------------------------	-----------------

Commercial data

Product Group	4 (Printed Circuit Connectors)
eCl@ss 10.0	27-44-04-01
eCl@ss 9.0	27-44-04-01
ETIM 8.0	EC002643
ETIM 7.0	EC002643
ECCN	NO DATA
PU (SPU)	40 pcs
Packaging type	box
Country of origin	PL
GTIN	4045454625467
Customs tariff number	85369010000

Subject to changes. Please also observe the further product documentation!





Environmental Product Compliance

RoHS Compliance Status



Compliant, No Exemption

Approvals / Certificates

General approvals

Logo	Approval	Additional Approval Text	Certificate name
	CCA DEKRA Certification B.V.	EN 60947	2160584.16
	CCA DEKRA Certification B.V.	EN 60947	NTR NL-7097
	CSA DEKRA Certification B.V.	C22.2 No. 158	1604421
	cURus Underwriters Laboratories Inc.	UL 1059	E45172

Declarations of conformity and manufacturer's declarations

Logo	Approval	Additional Approval Text	Certificate name
	EU-Declaration of Conformity WAGO GmbH & Co. KG	-	-
	UK-Declaration of Conformity WAGO GmbH & Co. KG	-	-

Optional accessories

Tool

Operating tool

Subject to changes. Please also observe the further product documentation!

**Item no.: 210-721**

Operating tool; Blade: 5.5 x 0.8 mm; with a partially insulated shaft; multicoloured

www.wago.com/210-721

Testing and measuring

Testing accessories













**Item no.: 210-136**

Test plug; 2 mm Ø; with 500 mm cable; red

www.wago.com/210-136

Ferrule











Ferrule

	Item no.: 216-101 Ferrule; Sleeve for 0.5 mm ² / AWG 22; uninsulated; electro-tin plated; silver-colored	www.wago.com/216-101
	Item no.: 216-104 Ferrule; Sleeve for 1.5 mm ² / AWG 16; uninsulated; electro-tin plated; silver-colored	www.wago.com/216-104
	Item no.: 216-106 Ferrule; Sleeve for 2.5 mm ² / AWG 14; uninsulated; electro-tin plated; silver-colored	www.wago.com/216-106
	Item no.: 216-107 Ferrule; Sleeve for 4 mm ² / AWG 12; uninsulated; electro-tin plated	www.wago.com/216-107
	Item no.: 216-102 Ferrule; Sleeve for 0.75 mm ² / AWG 20; uninsulated; electro-tin plated; silver-colored	www.wago.com/216-102
	Item no.: 216-103 Ferrule; Sleeve for 1 mm ² / AWG 18; uninsulated; electro-tin plated	www.wago.com/216-103
	Item no.: 216-123 Ferrule; Sleeve for 1 mm ² / AWG 18; uninsulated; electro-tin plated; silver-colored	www.wago.com/216-123
	Item no.: 216-122 Ferrule; Sleeve for 0.75 mm ² / AWG 20; uninsulated; electro-tin plated; silver-colored	www.wago.com/216-122
	Item no.: 216-124 Ferrule; Sleeve for 1.5 mm ² / AWG 16; uninsulated; electro-tin plated	www.wago.com/216-124
	Item no.: 216-142 Ferrule; Sleeve for 0.75 mm ² / 18 AWG; uninsulated; electro-tin plated; electrolytic copper; gastight crimped; acc. to DIN 46228, Part 1/08.92	www.wago.com/216-142
	Item no.: 216-132 Ferrule; Sleeve for 0.34 mm ² / AWG 24; uninsulated; electro-tin plated	www.wago.com/216-132
	Item no.: 216-121 Ferrule; Sleeve for 0.5 mm ² / AWG 22; uninsulated; electro-tin plated; silver-colored	www.wago.com/216-121
	Item no.: 216-143 Ferrule; Sleeve for 1 mm ² / AWG 18; uninsulated; electro-tin plated; electrolytic copper; gastight crimped; acc. to DIN 46228, Part 1/08.92	www.wago.com/216-143

Subject to changes. Please also observe the further product documentation!

	Item no.: 216-131 Ferrule; Sleeve for 0.25 mm ² / AWG 24; uninsulated; electro-tin plated; silver-colored	www.wago.com/216-131
	Item no.: 216-141 Ferrule; Sleeve for 0.5 mm ² / 20 AWG; uninsulated; electro-tin plated; electrolytic copper; gastight crimped; acc. to DIN 46228, Part 1/08.92	www.wago.com/216-141
	Item no.: 216-152 Ferrule; Sleeve for 0.34 mm ² / AWG 24; uninsulated; electro-tin plated	www.wago.com/216-152
	Item no.: 216-203 Ferrule; Sleeve for 1 mm ² / AWG 18; insulated; electro-tin plated; red	www.wago.com/216-203
	Item no.: 216-206 Ferrule; Sleeve for 2.5 mm ² / AWG 14; insulated; electro-tin plated; blue	www.wago.com/216-206
	Item no.: 216-207 Ferrule; Sleeve for 4 mm ² / AWG 12; insulated; electro-tin plated; gray	www.wago.com/216-207
	Item no.: 216-202 Ferrule; Sleeve for 0.75 mm ² / 18 AWG; insulated; electro-tin plated; gray	www.wago.com/216-202
	Item no.: 216-151 Ferrule; Sleeve for 0.25 mm ² / AWG 24; uninsulated; electro-tin plated	www.wago.com/216-151
	Item no.: 216-204 Ferrule; Sleeve for 1.5 mm ² / AWG 16; insulated; electro-tin plated; black	www.wago.com/216-204
	Item no.: 216-205 Ferrule; Sleeve for 2.08 mm ² / AWG 14; insulated; electro-tin plated; yellow	www.wago.com/216-205
	Item no.: 216-144 Ferrule; Sleeve for 1.5 mm ² / AWG 16; uninsulated; electro-tin plated; electrolytic copper; gastight crimped; acc. to DIN 46228, Part 1/08.92; silver-colored	www.wago.com/216-144
	Item no.: 216-201 Ferrule; Sleeve for 0.5 mm ² / 20 AWG; insulated; electro-tin plated; white	www.wago.com/216-201
	Item no.: 216-223 Ferrule; Sleeve for 1 mm ² / AWG 18; insulated; electro-tin plated; red	www.wago.com/216-223
	Item no.: 216-241 Ferrule; Sleeve for 0.5 mm ² / 20 AWG; insulated; electro-tin plated; electrolytic copper; gastight crimped; acc. to DIN 46228, Part 4/09.90; white	www.wago.com/216-241
	Item no.: 216-242 Ferrule; Sleeve for 0.75 mm ² / 18 AWG; insulated; electro-tin plated; electrolytic copper; gastight crimped; acc. to DIN 46228, Part 4/09.90; gray	www.wago.com/216-242
	Item no.: 216-222 Ferrule; Sleeve for 0.75 mm ² / 18 AWG; insulated; electro-tin plated; gray	www.wago.com/216-222
	Item no.: 216-221 Ferrule; Sleeve for 0.5 mm ² / 20 AWG; insulated; electro-tin plated; white	www.wago.com/216-221
	Item no.: 216-224 Ferrule; Sleeve for 1.5 mm ² / AWG 16; insulated; electro-tin plated; black	www.wago.com/216-224

Subject to changes. Please also observe the further product documentation!

	Item no.: 216-243 Ferrule; Sleeve for 1 mm ² / AWG 18; insulated; electro-tin plated; electrolytic copper; gastight crimped; acc. to DIN 46228, Part 4/09.90; red	www.wago.com/216-243
	Item no.: 216-244 Ferrule; Sleeve for 1.5 mm ² / AWG 16; insulated; electro-tin plated; electrolytic copper; gastight crimped; acc. to DIN 46228, Part 4/09.90; black	www.wago.com/216-244
	Item no.: 216-263 Ferrule; Sleeve for 1 mm ² / AWG 18; insulated; electro-tin plated; electrolytic copper; gastight crimped; acc. to DIN 46228, Part 4/09.90; red	www.wago.com/216-263
	Item no.: 216-246 Ferrule; Sleeve for 2.5 mm ² / AWG 14; insulated; electro-tin plated; electrolytic copper; gastight crimped; acc. to DIN 46228, Part 4/09.90; blue	www.wago.com/216-246
	Item no.: 216-266 Ferrule; Sleeve for 2.5 mm ² / AWG 14; insulated; electro-tin plated; electrolytic copper; gastight crimped; acc. to DIN 46228, Part 4/09.90; blue	www.wago.com/216-266
	Item no.: 216-264 Ferrule; Sleeve for 1.5 mm ² / AWG 16; insulated; electro-tin plated; electrolytic copper; gastight crimped; acc. to DIN 46228, Part 4/09.90; black	www.wago.com/216-264
	Item no.: 216-286 Ferrule; Sleeve for 2.5 mm ² / AWG 14; insulated; electro-tin plated; electrolytic copper; gastight crimped; acc. to DIN 46228, Part 4/09.90; blue	www.wago.com/216-286
	Item no.: 216-287 Ferrule; Sleeve for 4 mm ² / AWG 12; insulated; electro-tin plated; electrolytic copper; gastight crimped; acc. to DIN 46228, Part 4/09.90; gray	www.wago.com/216-287
	Item no.: 216-262 Ferrule; Sleeve for 0.75 mm ² / 18 AWG; insulated; electro-tin plated; electrolytic copper; gastight crimped; acc. to DIN 46228, Part 4/09.90; gray	www.wago.com/216-262
	Item no.: 216-301 Ferrule; Sleeve for 0.25 mm ² / AWG 24; insulated; electro-tin plated; yellow	www.wago.com/216-301
	Item no.: 216-321 Ferrule; Sleeve for 0.25 mm ² / AWG 24; insulated; electro-tin plated; yellow	www.wago.com/216-321
	Item no.: 216-322 Ferrule; Sleeve for 0.34 mm ² / 22 AWG; insulated; electro-tin plated; light turquoise	www.wago.com/216-322
	Item no.: 216-267 Ferrule; Sleeve for 4 mm ² / AWG 12; insulated; electro-tin plated; electrolytic copper; gastight crimped; acc. to DIN 46228, Part 4/09.90; gray	www.wago.com/216-267
	Item no.: 216-302 Ferrule; Sleeve for 0.34 mm ² / 22 AWG; insulated; electro-tin plated; light turquoise	www.wago.com/216-302

Marking accessories

Marker

Item no.: 2009-115/000-002

WMB-Inline; for Smart Printer; 1500 pieces on roll; stretchable 5 - 5.2 mm; plain; snap-on type; yellow

www.wago.com/2009-115

/000-002

Subject to changes. Please also observe the further product documentation!

WAGO GmbH & Co. KG

Hansastr. 27

32423 Minden

Phone: +49571 887-0 | Fax: +49571 887-169

 Email: info.de@wago.com | Web: www.wago.com

Do you have any questions about our products?

We are always happy to take your call at +49 (571) 887-44222.



Item no.: 2009-115/000-007

WMB-Inline; for Smart Printer; 1500 pieces on roll; stretchable 5 - 5.2 mm; plain; snap-on type; gray

www.wago.com/2009-115/000-007



Item no.: 2009-115/000-017

WMB-Inline; for Smart Printer; 1500 pieces on roll; stretchable 5 - 5.2 mm; plain; snap-on type; light green

www.wago.com/2009-115/000-017



Item no.: 2009-115/000-023

WMB-Inline; for Smart Printer; 1500 pieces on roll; stretchable 5 - 5.2 mm; plain; snap-on type; green

www.wago.com/2009-115/000-023



Item no.: 2009-115/000-024

WMB-Inline; for Smart Printer; 1500 pieces on roll; stretchable 5 - 5.2 mm; plain; snap-on type; violet

www.wago.com/2009-115/000-024

Item no.: 2009-145/000-006

Mini-WSB Inline; for Smart Printer; 1700 pieces on roll; stretchable 5 - 5.2 mm; plain; snap-on type; blue

www.wago.com/2009-145/000-006

Item no.: 2009-145

Mini-WSB Inline; for Smart Printer; 1700 pieces on roll; stretchable 5 - 5.2 mm; plain; snap-on type; white

www.wago.com/2009-145

Item no.: 2009-145/000-002

Mini-WSB Inline; for Smart Printer; 1700 pieces on roll; stretchable 5 - 5.2 mm; plain; snap-on type; yellow

www.wago.com/2009-145/000-002

Item no.: 2009-145/000-007

Mini-WSB Inline; for Smart Printer; 1700 pieces on roll; stretchable 5 - 5.2 mm; plain; snap-on type; gray

www.wago.com/2009-145/000-007

Item no.: 2009-145/000-005

Mini-WSB Inline; for Smart Printer; 1700 pieces on roll; stretchable 5 - 5.2 mm; plain; snap-on type; red

www.wago.com/2009-145/000-005

Item no.: 2009-145/000-012

Mini-WSB Inline; for Smart Printer; 1700 pieces on roll; stretchable 5 - 5.2 mm; plain; snap-on type; orange

www.wago.com/2009-145/000-012

Item no.: 2009-145/000-023

Mini-WSB Inline; for Smart Printer; 1700 pieces on roll; stretchable 5 - 5.2 mm; plain; snap-on type; green

www.wago.com/2009-145/000-023

Item no.: 2009-145/000-024

Mini-WSB Inline; for Smart Printer; 1700 pieces on roll; stretchable 5 - 5.2 mm; plain; snap-on type; violet

www.wago.com/2009-145/000-024

Subject to changes. Please also observe the further product documentation!

WAGO GmbH & Co. KG

Hansastr. 27

32423 Minden

Phone: +49571 887-0 | Fax: +49571 887-169

Email: info.de@wago.com | Web: www.wago.com

Do you have any questions about our products?

We are always happy to take your call at +49 (571) 887-44222.



Item no.: 2009-115

WMB-Inline; for Smart Printer; 1500 pieces on roll; stretchable 5 - 5.2 mm; plain; snap-on type; white

www.wago.com/2009-115



Item no.: 248-501/000-006

Mini-WSB marking card; as card; not stretchable; plain; snap-on type; blue

www.wago.com/248-501/000-006



Item no.: 248-501/000-007

Mini-WSB marking card; as card; not stretchable; plain; snap-on type; gray

www.wago.com/248-501/000-007



Item no.: 248-501/000-002

Mini-WSB marking card; as card; not stretchable; plain; snap-on type; yellow

www.wago.com/248-501/000-002



Item no.: 248-501/000-012

Mini-WSB marking card; as card; not stretchable; plain; snap-on type; orange

www.wago.com/248-501/000-012



Item no.: 248-501

Mini-WSB marking card; as card; not stretchable; plain; snap-on type; white

www.wago.com/248-501



Item no.: 248-501/000-017

Mini-WSB marking card; as card; not stretchable; plain; snap-on type; light green

www.wago.com/248-501/000-017



Item no.: 248-501/000-005

Mini-WSB marking card; as card; not stretchable; plain; snap-on type; red

www.wago.com/248-501/000-005



Item no.: 248-501/000-024

Mini-WSB marking card; as card; not stretchable; plain; snap-on type; violet

www.wago.com/248-501/000-024



Item no.: 248-501/000-023

Mini-WSB marking card; as card; not stretchable; plain; snap-on type; green

www.wago.com/248-501/000-023



Item no.: 793-5501/000-007

WMB marking card; as card; for terminal block width 5 - 17.5 mm; stretchable 5 - 5.2 mm; plain; snap-on type; gray

www.wago.com/793-5501/000-007



Item no.: 793-5501/000-012

WMB marking card; as card; for terminal block width 5 - 17.5 mm; stretchable 5 - 5.2 mm; plain; snap-on type; orange

www.wago.com/793-5501/000-012

Subject to changes. Please also observe the further product documentation!

WAGO GmbH & Co. KG

Hansastr. 27

32423 Minden

Phone: +49571 887-0 | Fax: +49571 887-169

Email: info.de@wago.com | Web: www.wago.com

Do you have any questions about our products?

We are always happy to take your call at +49 (571) 887-44222.



Item no.: 793-5501/000-017

WMB marking card; as card; for terminal block width 5 - 17.5 mm; stretchable 5 - 5.2 mm; plain; snap-on type; light green

www.wago.com/793-5501/000-017



Item no.: 793-5501/000-023

WMB marking card; as card; for terminal block width 5 - 17.5 mm; stretchable 5 - 5.2 mm; plain; snap-on type; green

www.wago.com/793-5501/000-023



Item no.: 793-5501/000-024

WMB marking card; as card; for terminal block width 5 - 17.5 mm; stretchable 5 - 5.2 mm; plain; snap-on type; violet

www.wago.com/793-5501/000-024



Item no.: 793-501/000-002

WMB marking card; as card; not stretchable; plain; snap-on type; yellow

www.wago.com/793-501/000-002



Item no.: 793-501/000-007

WMB marking card; as card; not stretchable; plain; snap-on type; gray

www.wago.com/793-501/000-007



Item no.: 793-501/000-017

WMB marking card; as card; not stretchable; plain; snap-on type; light green

www.wago.com/793-501/000-017



Item no.: 793-501/000-012

WMB marking card; as card; not stretchable; plain; snap-on type; orange

www.wago.com/793-501/000-012



Item no.: 793-501/000-023

WMB marking card; as card; not stretchable; plain; snap-on type; green

www.wago.com/793-501/000-023



Item no.: 793-501/000-006

WMB marking card; as card; not stretchable; plain; snap-on type; blue

www.wago.com/793-501/000-006



Item no.: 793-501/000-005

WMB marking card; as card; not stretchable; plain; snap-on type; red

www.wago.com/793-501/000-005



Item no.: 793-501

WMB marking card; as card; not stretchable; plain; snap-on type; white

www.wago.com/793-501

Subject to changes. Please also observe the further product documentation!

WAGO GmbH & Co. KG

Hansastr. 27

32423 Minden

Phone: +49571 887-0 | Fax: +49571 887-169

Email: info.de@wago.com | Web: www.wago.com

Do you have any questions about our products?

We are always happy to take your call at +49 (571) 887-44222.



Item no.: 793-501/000-024
WMB marking card; as card; not stretchable; plain; snap-on type; violet

www.wago.com/793-501/000-024



Item no.: 793-5501/000-005
WMB marking card; as card; for terminal block width 5 - 17.5 mm; stretchable 5 - 5.2 mm; plain; snap-on type; red

www.wago.com/793-5501/000-005



Item no.: 793-5501/000-002
WMB marking card; as card; for terminal block width 5 - 17.5 mm; stretchable 5 - 5.2 mm; plain; snap-on type; yellow

www.wago.com/793-5501/000-002



Item no.: 793-5501/000-006
WMB marking card; as card; for terminal block width 5 - 17.5 mm; stretchable 5 - 5.2 mm; plain; snap-on type; blue

www.wago.com/793-5501/000-006



Item no.: 793-5501
WMB marking card; as card; for terminal block width 5 - 17.5 mm; stretchable 5 - 5.2 mm; plain; snap-on type; white

www.wago.com/793-5501



Item no.: 2009-115/000-012
WMB-Inline; for Smart Printer; 1500 pieces on roll; stretchable 5 - 5.2 mm; plain; snap-on type; orange

www.wago.com/2009-115/000-012



Item no.: 2009-115/000-006
WMB-Inline; for Smart Printer; 1500 pieces on roll; stretchable 5 - 5.2 mm; plain; snap-on type; blue

www.wago.com/2009-115/000-006

Downloads

Documentation

Additional Information

Technical Section	2019 Apr 3	pdf	Download
Technical explanations		2.1 MB	

CAD/CAE-Data

CAD data

2D/3D Models 745-1404	URL	Download
-----------------------	-----	----------

CAE data

EPLAN Data Portal 745-1404

Subject to changes. Please also observe the further product documentation!

WAGO GmbH & Co. KG
Hansastr. 27
32423 Minden
Phone: +49571 887-0 | Fax: +49571 887-169
Email: info.de@wago.com | Web: www.wago.com

Do you have any questions about our products?
We are always happy to take your call at +49 (571) 887-44222.



[URL](#) [Download](#)

ZUKEN Portal 745-1404

[URL](#) [Download](#)

PCB Design

Symbol and Footprint via Ultra Librarian 745-1404

[URL](#) [Download](#)

CAX data for your PCB design, consisting of "schematic symbols and PCB footprints", allow easy integration of the WAGO component into your development environment.

Supported formats:

- Accel EDA 14 & 15
- Altair
- Altium 6 to current version
- Autodesk Fusion 360
- Cadence Allegro
- DesignSpark
- Eagle Libraries
- KiCad
- Mentor Graphics
- BoardStation
- Mentor Graphics Design Architect
- Mentor Graphics Design
- Expedition 99 and 2000
- OrCAD 9.X PCB and Capture
- PADS PowerPCB 3, 3.5, 4.X, and 5.X
- PADS PowerPCB and PowerLogic 3.0
- PCAD 2000, 2001, 2002, 2004, and 2006
- Pulsonix 8.5 or newer
- STL
- 3D STEP
- TARGET 3001!
- View Logic ViewDraw
- Quadcept
- Zuken CadStar 3 and 4
- Zuken CR-5000 and CR-8000
- Zuken eCADSTAR 2020 and 2021Zuken CR-5000 and CR-8000

PCB Component Libraries (EDA), PCB CAD Library Ultra Librarian

Subject to changes. Please also observe the further product documentation!

WAGO GmbH & Co. KG

Hansastr. 27

32423 Minden

Phone: +49571 887-0 | Fax: +49571 887-169

Email: info.de@wago.com | Web: www.wago.com

Do you have any questions about our products?

We are always happy to take your call at +49 (571) 887-44222.



Symbol and Footprint via SamacSys 745-1404

[URL](#)

[Download](#)

CAX data for your PCB design, consisting of "schematic symbols and PCB footprints", allow easy integration of the WAGO component into your development environment.

Supported formats:

- 3D (stp)
- Altium
- CADSTAR
- Capture
- CircuitStudio
- CR-5000
- CR-8000
- DEHDL
- DesignSpark PCB
- DesignSpark PCB PRO
- DipTrace
- EAGLE
- Easy-PC
- EasyEDA
- eCADSTAR
- KiCad
- OrCAD_Allegro16
- PADS
- Proteus
- Pulsonix
- Quadcept
- SOLIDWORKS PCB
- TARGET 3001!
- xDX Designer
- Xpedition

PCB Component Libraries (EDA), PCB CAD Library SamacSys Electronic Component Search Engine

Asset Administration Shell

Asset Administration Shell 745-1404

[URL](#)

[Download](#)

Subject to changes. Please also observe the further product documentation!

WAGO GmbH & Co. KG

Hansastr. 27

32423 Minden

Phone: +49571 887-0 | Fax: +49571 887-169

Email: info.de@wago.com | Web: www.wago.com

Do you have any questions about our products?

We are always happy to take your call at +49 (571) 887-44222.

Environmental Product Compliance

Compliance Search

Environmental Product Compliance 745-1404

URL

Download

PCB terminal block; 6 mm²; Pin spacing 12.5 mm; 4-pole; CAGE CLAMP®; commoning option; 6,00 mm²; gray

Installation Notes

Conductor termination

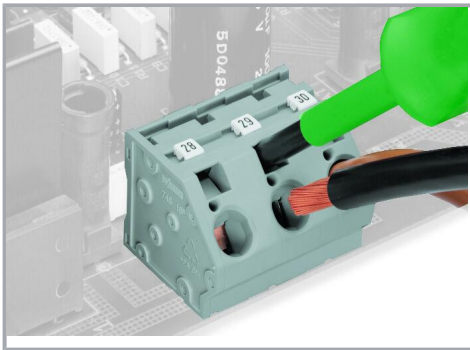

Inserting/removing a conductor via 5.5 mm screwdriver – 745 Series, 16 mm².

Marking

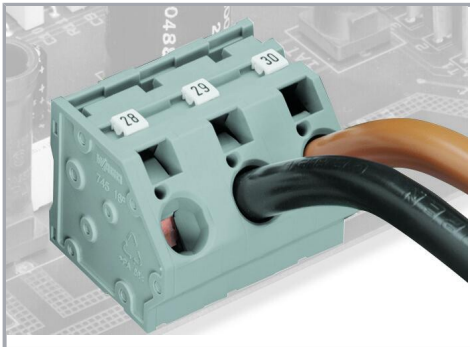

Marking via Mini-WSB and WMB markers or factory direct marking – 745 Series.

Testing

Subject to changes. Please also observe the further product documentation!

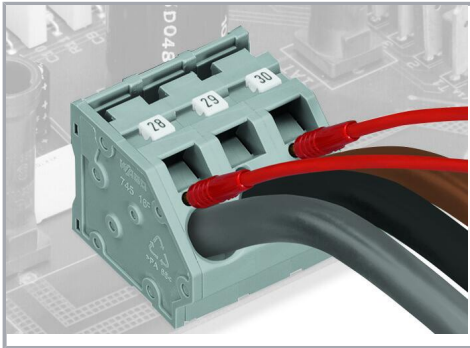

Testing with test plug – 745 Series.

Subject to changes. Please also observe the further product documentation!