

**Data sheet | Item number: 218-503**

PCB terminal block; Locking slides; 0.5 mm<sup>2</sup>; Pin spacing 2.54 mm; 3-pole;  
CAGE CLAMP®; 0,50 mm<sup>2</sup>; gray



[www.wago.com/218-503](http://www.wago.com/218-503)



**i** Picture differs from the item.

Color:

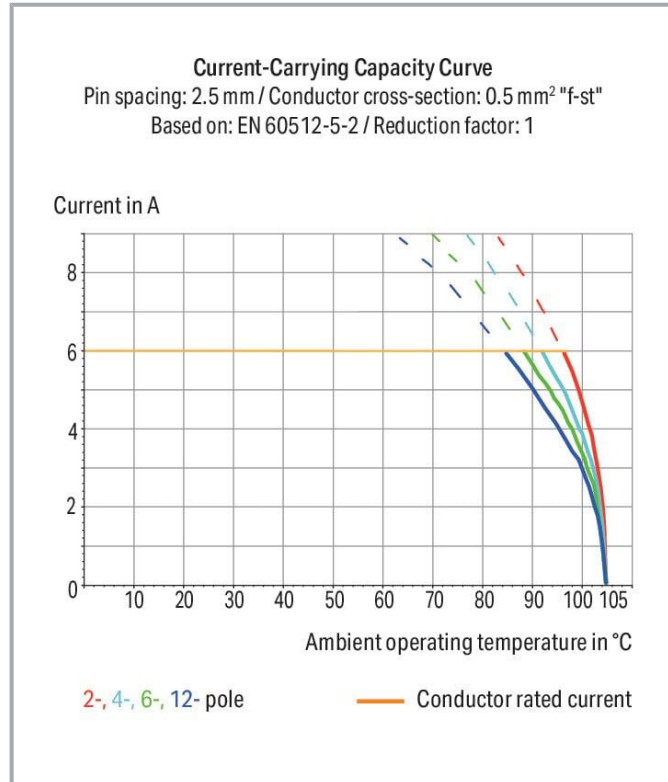

Subject to changes. Please also observe the further product documentation!

WAGO GmbH & Co. KG  
Hansastr. 27  
32423 Minden  
Phone: +49571 887-0 | Fax: +49571 887-169  
Email: [info.de@wago.com](mailto:info.de@wago.com) | Web: [www.wago.com](http://www.wago.com)

Do you have any questions about our products?  
We are always happy to take your call at +49 (571) 887-44222.

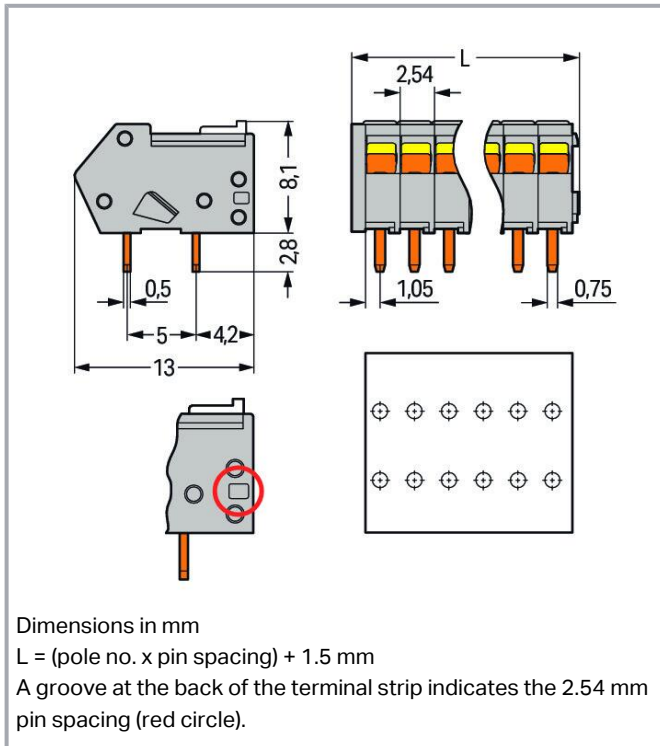

### Item description

- Terminal strips are just 8.1 mm tall and feature an innovative, locking slide-actuated CAGE CLAMP®.
- Several clamping units can be held open simultaneously.
- Easily terminate stranded conductors in tight spaces (e.g., bus connectors).

### Data

#### Notes

Variants:

Other pole numbers

Other colors

Mixed-color PCB connector strips

Direct marking

Other versions (or variants) can be requested from WAGO Sales or configured at <https://configurator.wago.com/>.

### Electrical data

#### Ratings per IEC/EN

Ratings per

IEC/EN 60664-1

Subject to changes. Please also observe the further product documentation!

WAGO GmbH & Co. KG

Hansastr. 27

32423 Minden

Phone: +49571 887-0 | Fax: +49571 887-169

Email: [info.de@wago.com](mailto:info.de@wago.com) | Web: [www.wago.com](http://www.wago.com)

Do you have any questions about our products?

We are always happy to take your call at +49 (571) 887-44222.



Nominal voltage (III/3)	80 V
Rated impulse voltage (III/3)	2.5 kV
Rated voltage (III/2)	160 V
Rated impulse voltage (III/2)	2.5 kV
Nominal voltage (II/2)	320 V
Rated surge voltage (II/2)	2.5 kV
Rated current	6 A
Legend (ratings)	(III / 2) ≙ Overvoltage category III / Pollution degree 2

### Ratings per UL

Approvals per	UL 1059
Rated voltage UL (Use Group B)	150 V
Rated current UL (Use Group B)	4 A

### Ratings per CSA

Approvals per	CSA
Rated voltage CSA (Use Group B)	150 V
Rated current CSA (Use Group B)	4 A

### Connection data

Connection points	3
Total number of potentials	3
Number of connection types	1
Number of levels	1

### Connection 1

Connection technology	CAGE CLAMP®
Actuation type	Slider
Solid conductor	0.08 ... 0.5 mm <sup>2</sup> / 28 ... 20 AWG
Fine-stranded conductor	0.08 ... 0.5 mm <sup>2</sup> / 28 ... 20 AWG
Fine-stranded conductor; with insulated ferrule	0.25 mm <sup>2</sup>
Fine-stranded conductor; with uninsulated ferrule	0.25 mm <sup>2</sup>
Note (conductor cross-section)	Terminating 0.75 mm <sup>2</sup> /18 AWG conductors is possible; however insulation diameter allows only every other clamping unit to be terminated with this conductor size.
Strip length	5 ... 6 mm / 0.2 ... 0.24 inches
Conductor connection direction to PCB	40 °

Subject to changes. Please also observe the further product documentation!



Pole number	3
-------------	---

### Physical data

Pin spacing	2.54 mm / 0.1 inches
Width	9.12 mm / 0.359 inches
Height	10.9 mm / 0.429 inches
Height from the surface	8.1 mm / 0.319 inches
Depth	13 mm / 0.512 inches
Solder pin length	2.8 mm
Solder pin dimensions	0.5 x 0.75 mm
Drilled hole diameter with tolerance	1.1 <sup>(+0.1)</sup> mm

### PCB contact

PCB contact	THT
Solder pin arrangement	over the entire terminal strip (in-line)
Number of solder pins per potential	2

### Material data

Note (material data)

[Information on material specifications can be found here](#)

Color	gray
Material group	I
Insulation material	Polyamide (PA66)
Flammability class per UL94	V0
Clamping spring material	Chrome-nickel spring steel (CrNi)
Contact material	Electrolytic copper (E <sub>Cu</sub> )
Contact plating	Tin
Fire load	0.051 MJ
Weight	1.1 g

### Environmental requirements

Limit temperature range	-60 ... +105 °C
-------------------------	-----------------

### Commercial data

Product Group	4 (Printed Circuit Connectors)
---------------	--------------------------------

Subject to changes. Please also observe the further product documentation!

WAGO GmbH & Co. KG  
 Hansastr. 27  
 32423 Minden  
 Phone: +49571 887-0 | Fax: +49571 887-169  
 Email: [info.de@wago.com](mailto:info.de@wago.com) | Web: [www.wago.com](http://www.wago.com)

Do you have any questions about our products?  
 We are always happy to take your call at +49 (571) 887-44222.

eCl@ss 10.0	27-44-04-01
eCl@ss 9.0	27-44-04-01
ETIM 8.0	EC002643
ETIM 7.0	EC002643
ECCN	NO DATA
PU (SPU)	1000 (100) pcs
Packaging type	Box
Country of origin	PL
GTIN	4044918878241
Customs tariff number	85369010000

### Environmental Product Compliance

RoHS Compliance Status	Compliant, No Exemption
------------------------	-------------------------

### Approvals / Certificates



#### General approvals

Logo	Approval	Additional Approval Text	Certificate name
	CCA DEKRA Certification B.V.	EN 60947	NTR NL-7076
	CCA DEKRA Certification B.V.	EN 60947-7-4	NTR NL-7785
	CCA DEKRA Certification B.V.	EN 60947-7-4	77-111038
	CSA DEKRA Certification B.V.	C22.2 No. 158	1565656
	ENEC DEKRA Certification B.V.	EN 60947	2160584.01
	UL UL International Germany GmbH	UL 1059	E45172

Subject to changes. Please also observe the further product documentation!



## Declarations of conformity and manufacturer's declarations

Logo	Approval	Additional Approval Text	Certificate name
	EU-Declaration of Conformity WAGO GmbH & Co. KG	-	-
	UK-Declaration of Conformity WAGO GmbH & Co. KG	-	-

## Optional accessories



## Testing and measuring

## Testing accessories

	<b>Item no.: 735-500</b> WAGO Test pin; 1 mm Ø; 30 V AC / 60 V DC; CAT0; 1 A; 6 mm uninsulated; Test lead for soldering up to 0,5mm <sup>2</sup>	<a href="http://www.wago.com/735-500">www.wago.com/735-500</a>
---	---	--



## Tool

## Operating tool

	<b>Item no.: 210-648</b> Operating tool; Blade: 2.5 x 0.4 mm; with a partially insulated shaft; angled; short	<a href="http://www.wago.com/210-648">www.wago.com/210-648</a>
	<b>Item no.: 210-719</b> Operating tool; Blade: 2.5 x 0.4 mm; with a partially insulated shaft	<a href="http://www.wago.com/210-719">www.wago.com/210-719</a>

## Marking accessories

## Marking strip

	<b>Item no.: 210-331/254-204</b> Marking strips; as a DIN A4 sheet; MARKED; 17-32 (400x); Height of marker strip: 2.3 mm/0.091 in; Strip length 182 mm; Horizontal marking; Self-adhesive; white	<a href="http://www.wago.com/210-331/254-204">www.wago.com/210-331/254-204</a>
	<b>Item no.: 210-331/254-206</b> Marking strips; as a DIN A4 sheet; MARKED; 33-48 (400x); Height of marker strip: 2.3 mm/0.091 in; Strip length 182 mm; Horizontal marking; Self-adhesive; white	<a href="http://www.wago.com/210-331/254-206">www.wago.com/210-331/254-206</a>
	<b>Item no.: 210-331/254-202</b> Marking strips; as a DIN A4 sheet; MARKED; 1-16 (400x); Height of marker strip: 2.3 mm/0.091 in; Strip length 182 mm; Horizontal marking; Self-adhesive; white	<a href="http://www.wago.com/210-331/254-202">www.wago.com/210-331/254-202</a>

Subject to changes. Please also observe the further product documentation!

WAGO GmbH & Co. KG  
Hansastr. 27  
32423 Minden  
Phone: +49571 887-0 | Fax: +49571 887-169  
Email: [info.de@wago.com](mailto:info.de@wago.com) | Web: [www.wago.com](http://www.wago.com)

Do you have any questions about our products?  
We are always happy to take your call at +49 (571) 887-44222.

**Item no.: 210-331/254-207**

Marking strips; as a DIN A4 sheet; MARKED; 1-48 (100x); Height of marker strip: 2.3 mm/0.091 in; Strip length 182 mm; Horizontal marking; Self-adhesive; white

[www.wago.com/210-331/254-207](http://www.wago.com/210-331/254-207)

**Ferrule**

## Ferrule

	<b>Item no.: 216-131</b> Ferrule; Sleeve for 0.25 mm <sup>2</sup> / AWG 24; uninsulated; electro-tin plated; silver-colored	<a href="http://www.wago.com/216-131">www.wago.com/216-131</a>
	<b>Item no.: 216-151</b> Ferrule; Sleeve for 0.25 mm <sup>2</sup> / AWG 24; uninsulated; electro-tin plated	<a href="http://www.wago.com/216-151">www.wago.com/216-151</a>
	<b>Item no.: 216-301</b> Ferrule; Sleeve for 0.25 mm <sup>2</sup> / AWG 24; insulated; electro-tin plated; yellow	<a href="http://www.wago.com/216-301">www.wago.com/216-301</a>
	<b>Item no.: 216-321</b> Ferrule; Sleeve for 0.25 mm <sup>2</sup> / AWG 24; insulated; electro-tin plated; yellow	<a href="http://www.wago.com/216-321">www.wago.com/216-321</a>

**Downloads****Documentation****Additional Information**

Technical Section	2019 Apr 3	pdf	Download
Technical explanations		2.1 MB	

**CAD/CAE-Data****CAD data**

2D/3D Models 218-503	URL	Download
----------------------	-----	----------

**CAE data**

EPLAN Data Portal 218-503	URL	Download
---------------------------	-----	----------

ZUKEN Portal 218-503	URL	Download
----------------------	-----	----------

**PCB Design**

Symbol and Footprint via Ultra Librarian 218-503	URL	Download
--	-----	----------

CAX data for your PCB design, consisting of "schematic symbols and PCB footprints", allow easy integration of the WAGO component into your development environment.

Supported formats:

Subject to changes. Please also observe the further product documentation!



- Accel EDA 14 & 15
- Altair
- Altium 6 to current version
- Autodesk Fusion 360
- Cadence Allegro
- DesignSpark
- Eagle Libraries
- KiCad
- Mentor Graphics
- BoardStation
- Mentor Graphics Design Architect
- Mentor Graphics Design
- Expedition 99 and 2000
- OrCAD 9.X PCB and Capture
- PADS PowerPCB 3, 3.5, 4.X, and 5.X
- PADS PowerPCB and PowerLogic 3.0
- PCAD 2000, 2001, 2002, 2004, and 2006
- Pulsonix 8.5 or newer
- STL
- 3D STEP
- TARGET 3001!
- View Logic ViewDraw
- Quadcept
- Zuken CadStar 3 and 4
- Zuken CR-5000 and CR-8000
- Zuken eCADSTAR 2020 and 2021Zuken CR-5000 and CR-8000

PCB Component Libraries (EDA), PCB CAD Library Ultra Librarian

---

Symbol and Footprint via SamacSys 218-503

[URL](#)

[Download](#)

CAX data for your PCB design, consisting of "schematic symbols and PCB footprints", allow easy integration of the WAGO component into your development environment.

Supported formats:

- 3D (stp)
- Altium
- CADSTAR
- Capture

—  
Subject to changes. Please also observe the further product documentation!

---

WAGO GmbH & Co. KG

Hansastr. 27

32423 Minden

Phone: +49571 887-0 | Fax: +49571 887-169

Email: [info.de@wago.com](mailto:info.de@wago.com) | Web: [www.wago.com](http://www.wago.com)

Do you have any questions about our products?

We are always happy to take your call at +49 (571) 887-44222.





- CircuitStudio
- CR-5000
- CR-8000
- DEHDL
- DesignSpark PCB
- DesignSpark PCB PRO
- DipTrace
- EAGLE
- Easy-PC
- EasyEDA
- eCADSTAR
- KiCad
- OrCAD\_Allegro16
- PADS
- Proteus
- Pulsonix
- Quadcept
- SOLIDWORKS PCB
- TARGET 3001!
- xDX Designer
- Xpedition

PCB Component Libraries (EDA), PCB CAD Library SamacSys Electronic Component Search Engine

---

#### Asset Administration Shell

Asset Administration Shell 218-503	URL	Download

---

#### Environmental Product Compliance

##### Compliance Search

Environmental Product Compliance 218-503	URL	Download
PCB terminal block; Locking slides; 0.5 mm <sup>2</sup> ; Pin spacing 2.54 mm; 3-pole; CAGE CLAMP®; 0,50 mm <sup>2</sup> ; gray		

---

#### Installation Notes

Subject to changes. Please also observe the further product documentation!

---

WAGO GmbH & Co. KG  
Hansastr. 27  
32423 Minden  
Phone: +49571 887-0 | Fax: +49571 887-169  
Email: [info.de@wago.com](mailto:info.de@wago.com) | Web: [www.wago.com](http://www.wago.com)

Do you have any questions about our products?  
We are always happy to take your call at +49 (571) 887-44222.

### Conductor termination

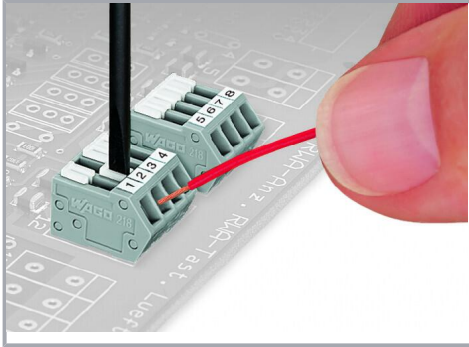

Terminating stranded conductors in confined spaces requires a great deal of patience, unless you use the new 218 Series PCB Terminal Strips. The clamping units of these strips can be held open during termination process via integrated locking slide.

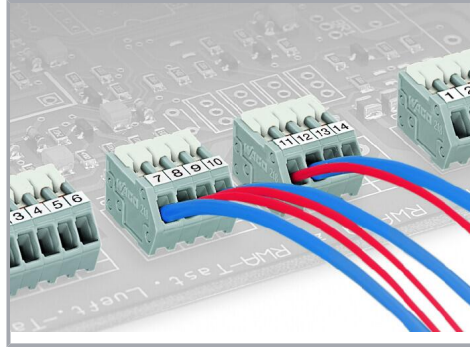

Terminating 0.75 mm<sup>2</sup>/18 AWG conductors is possible; however insulation diameter allows only every other clamping unit to be terminated with this conductor size.

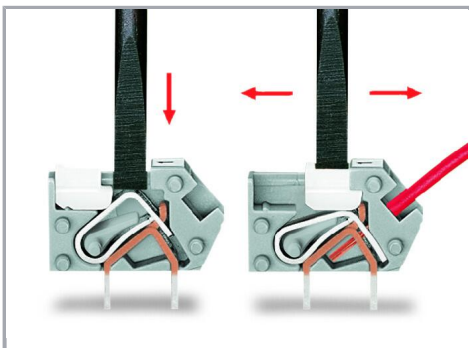

Conductor termination: To momentarily open the clamping unit, use screwdriver and then insert a stripped conductor. To open clamping unit for an extended period, move locking slide toward conductor entry hole. Then fully insert stripped conductor and move locking slide back to original position (also possible to perform with fingernail).

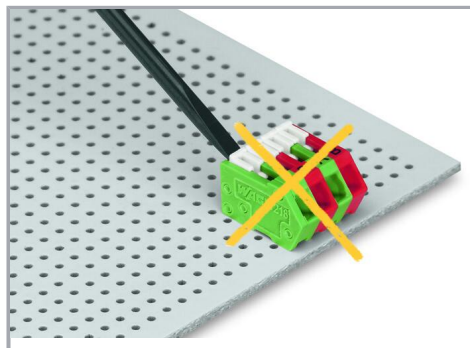

Incorrect – do not operate the locking slides from the back.

### Marking

Subject to changes. Please also observe the further product documentation!

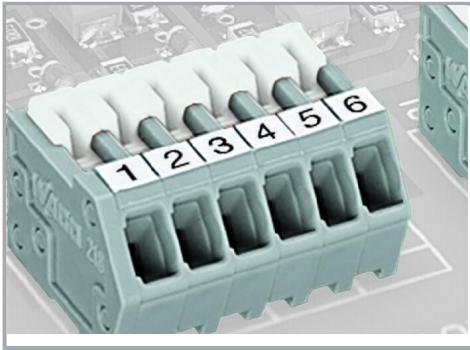

Labeling with self-adhesive marking strips.

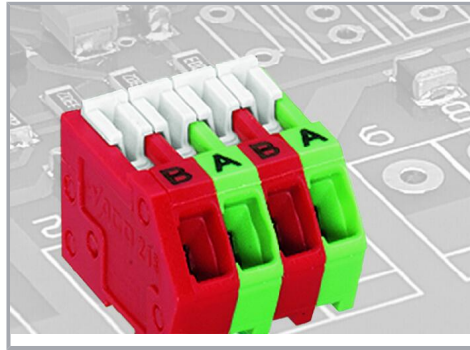

Labeling via factory direct marking.

### Testing

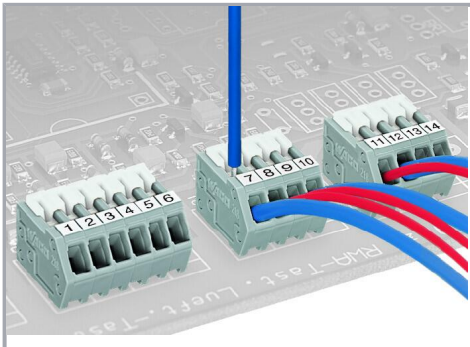

Testing directly on the clamping spring.

Subject to changes. Please also observe the further product documentation!