

PCB terminal, Tension-spring connection, No. of poles: 8, Width: 62.9 mm, Colour: Green

Business data

Article number	<u>10888.1</u>
Article name	PZK 3011/8/7,50/7,62-KD GN
GTIN (EAN)	4044211014971
Packaging unit	50
Quantity unit	PC
Packaging type	Carton
Type of banding	Without
Weight per piece (not including packaging)	9.2 g
Weight per piece (including packaging)	10.1 g
Unit of weight	G
Customs number	85369010
Country of origin	QU
Prio-Article	10888.1

Technical data

Dimensions

Length	14.2 mm
Length of the pin	4 mm
Width	62.9 mm
Width left	3.65 mm
Width right	6.75 mm
Height	18.7 mm
Drill hole diameter	1.1 mm
Diameter of connecting pin	0.7 mm
Pitch	7.5 mm

Ratings

Rated voltage	750 V
Rated current	24 A
Rated cross-section	2.5 mm ²
Rated impulse voltage	3 kV
Overvoltage category	III
Contamination degree	3

Connection data

Connection principle	Tension-spring connection
Connection type of PCB	Solder connection
Type of attachment to circuit board	Connecting contact
Angle of PCB/wire connection	45°/135° (slanted upwards)
No. of poles	8
Number of levels	1
Wire cross-section single-core (rigid) / stranded, min.	0.08 mm ²
Wire cross-section single core (rigid)/stranded, max.	2.5 mm ²
Wire cross-section stranded, min.	0.14 mm ²
Wire cross-section stranded, max.	2.5 mm ²
Wire cross-section stranded with wire-end ferrules, min.	0.14 mm ²
Wire cross-section stranded with wire-end ferrules, max.	1.5 mm ²
Wire cross-section AWG, min.	28
Wire cross-section AWG, max.	14
Stripping length	6 mm

Technical data

Materials

Insulation housing	Polyamide 6.6
Flammability class UL 94	V-0
Working temperature, min.	-30 °C
Working temperature, max.	105 °C
Tension spring	Stainless steel
Soldering lug	Copper alloy

Further technical data

Storage temperature, min.	-40 °C
Storage temperature, max.	105 °C
Insulation resistance	1*10 ¹³ Ohm x cm
Creepage-current resistance	CTI 600
Glow wire flammability index GWFI	GWFI 850
GWFI after-glow time	30 Sek.
Glow wire ignition temperature GWIT	GWIT 775 °C
GWIT exposure time	5 Sek.
Connection cycles, in compliance with standard	10
Recommended wave soldering temperature	265 °C
Recommended wave soldering duration, min.	3 Sek.
Recommended wave soldering duration, max.	4 Sek.

Environmental Product Compliance

REACH Candidate Substance Note	No
--------------------------------	----

Approvals

cUL Recognized

cUL approval	CSA 22.2 No.158
cUL Usegroup B: rated voltage	300 V
cUL Usegroup B: rated current	16 A
cUL Usegroup D: rated voltage	300 V
cUL Usegroup D: rated current	10 A
cUL wire cross-section single-core (rigid) AWG, min.	28
cUL wire cross-section single-core (rigid) AWG, max.	14
cUL wire cross-section stranded AWG, min.	28
cUL wire cross-section stranded AWG, max.	14
cUL wire material	Cu
cUL Recognized	1

UL Recognized

UL approval	UL 1059
UL Usegroup B: rated voltage	300 V
UL Usegroup B: rated current	16 A
UL Usegroup D: rated voltage	300 V
UL Usegroup D: rated current	10 A
UL wire cross-section single-core (rigid) AWG, min.	28
UL wire cross-section single-core (rigid) AWG, max.	14
UL wire cross-section stranded AWG, min.	28
UL wire cross-section stranded AWG, max.	14
UL wire material	Cu
UL factory wiring	1
UL field wiring	1
UL Recognized	1

Approvals

VDE approval

VDE approval	DIN EN 60998
VDE approval granted	yes
VDE rated voltage	750 V
VDE rated current	24 A
VDE rated current wire cross-section rigid, max.	24 A
VDE rated current wire cross-section stranded, max.	24 A
VDE rated impulse voltage	3 kV
VDE wire cross-section rigid, min.	0.5 mm ²
VDE wire cross-section rigid, max.	2.5 mm ²
VDE wire cross-section stranded, min.	0.5 mm ²
VDE wire cross-section stranded, max.	2.5 mm ²
VDE overvoltage category	III
VDE contamination degree	3

Media



7.62 mm

7.50 mm

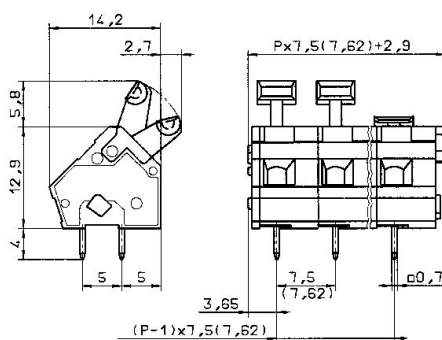
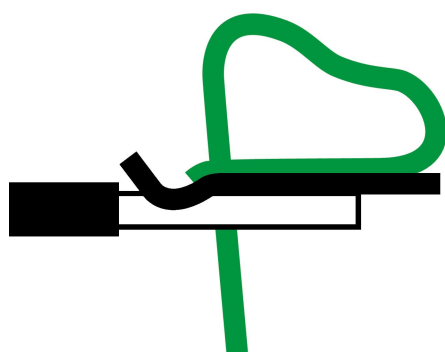

Accessories
