

TLC32040C, TLC32040I, TLC32041C, TLC32041I
TLC32042C, TLC32042I

ANALOG INTERFACE CIRCUITS

D2964, SEPTEMBER 1987—REVISED MAY 1991

- Advanced LinCMOS™ Silicon-Gate Process Technology
- 14-Bit Dynamic Range ADC and DAC
- Variable ADC and DAC Sampling Rate Up to 19,200 Samples per Second
- Switched-Capacitor Antialiasing Input Filter and Output-Reconstruction Filter
- Serial Port for Direct Interface to TMS32011, TMS320C17, TMS32020, and TMS320C25 Digital Processors
- Synchronous or Asynchronous ADC and DAC Conversion Rates with Programmable Incremental ADC and DAC Conversion Timing Adjustments
- Serial Port Interface to SN74299 Serial-to-Parallel Shift Register for Parallel Interface to TMS32010, TMS320C15, or Other Digital Processors
- 600-mil Wide N Package (C_L to C_L)

PART NUMBER	DESCRIPTION
TLC32040	Analog Interface Circuit with internal reference. Also a plug-in replacement for TLC32041.
TLC32041	Analog Interface Circuit without internal reference.
TLC32042	Identical to TLC32040, but has a slightly wider bandpass filter bandwidth

description

The TLC32040, TLC32041, and TLC32042 are complete analog-to-digital and digital-to-analog input/output systems, each on a single monolithic CMOS chip. This device integrates a bandpass switched-capacitor antialiasing input filter, a 14-bit-resolution A/D converter, four microprocessor-compatible output-reconstruction filter. The device offers numerous combinations of Master Clock input frequencies and conversion/sampling rates, which can be changed via digital processor control.

Typical applications for this IC include modems (7.2-, 8-, 9.6-, 14.4-, and 19.2-kHz sampling rate), analog interface for digital signal processors (DSPs), speech recognition/storage systems, industrial process control, biomedical instrumentation, acoustical signal processing, spectral analysis, data acquisition, and instrumentation recorders. Four serial modes, which allow direct interface to the TMS32011, TMS320C17, TMS32020, and TMS320C25 digital signal processors, are provided. Also, when the transmit and receive sections of the Analog Interface Circuit (AIC) are operating synchronously, it will interface to two SN74299

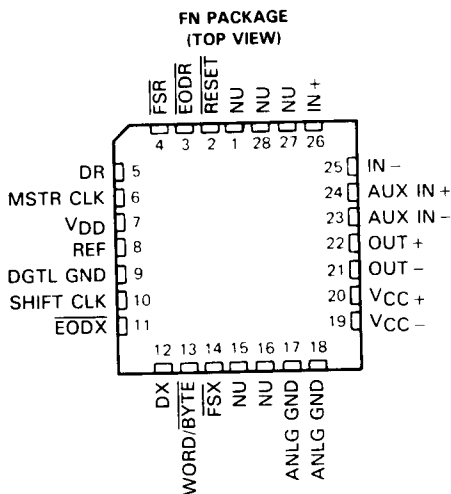
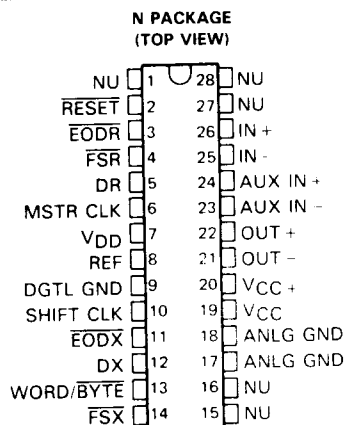

NU — Nonusable; no external connection should be made to these pins.

Advanced LinCMOS™ is a trademark of Texas Instruments Incorporated

PRODUCTION DATA documents contain information current as of publication date. Products conform to specifications per the terms of Texas Instruments standard warranty. Production processing does not necessarily include testing of all parameters.



POST OFFICE BOX 655303 • DALLAS, TEXAS 75265

Copyright © 1991, Texas Instruments Incorporated

TLC32040C, TLC32040I, TLC32041C, TLC32041I TLC32042C, TLC32042I ANALOG INTERFACE CIRCUITS

description (continued)

serial-to-parallel shift registers. These serial-to-parallel shift registers can then interface in parallel to the TMS32010, TMS320C15, other digital signal processors, or external FIFO circuitry. Output data pulses are emitted to inform the processor that data transmission is complete or to allow the DSP to differentiate between two transmitted bytes. A flexible control scheme is provided so that the functions of the IC can be selected and adjusted coincidentally with signal processing via software control.

The antialiasing input filter comprises seventh-order and fourth-order CC-type (Chebyshev/elliptic transitional) low-pass and high-pass filters, respectively, and a fourth-order equalizer. The input filter is implemented in switched-capacitor technology and is preceded by a continuous time filter to eliminate any possibility of aliasing caused by sampled data filtering. When no filtering is desired, the entire composite filter can be switched out of the signal path. A selectable, auxiliary, differential analog input is provided for applications where more than one analog input is required.

The A/D and D/A converters each have 14 bits of resolution. The A/D and D/A architectures ensure no missing codes and monotonic operation. An internal voltage reference is provided on the TLC32040 and TLC32042 to ease the design task and to provide complete control over the performance of the IC. The internal voltage reference is brought out to a pin and is available to the designer. Separate analog and digital voltage supplies and grounds are provided to minimize noise and ensure a wide dynamic range. Also, the analog circuit path contains only differential circuitry to keep noise to an absolute minimum. The only exception is the DAC sample-and-hold, which utilizes pseudo-differential circuitry.

The output-reconstruction filter is a seventh-order CC-type (Chebyshev/elliptic transitional low-pass filter with a fourth-order equalizer) and is implemented in switched-capacitor technology. This filter is followed by a continuous-time filter to eliminate images of the digitally encoded signal.

The TLC32040C, TLC32041C, and TLC32042C are characterized for operation from 0°C to 70°C and the TLC32040I, TLC32041I, and TLC32042I are characterized for operation from -40°C to 85°C.

functional block diagram

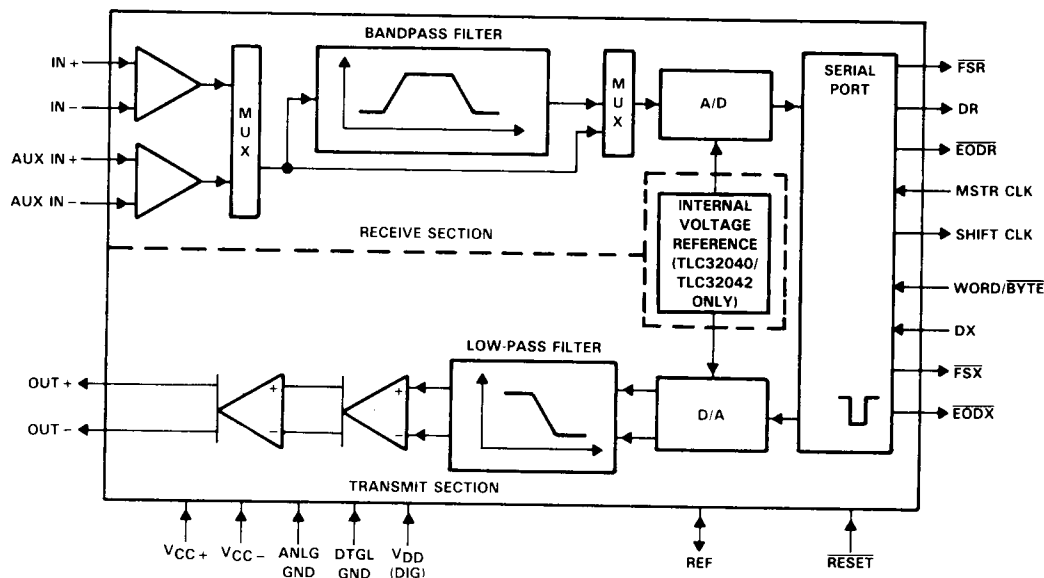

PRINCIPLES OF OPERATION

analog input

Two sets of analog inputs are provided. Normally, the IN + and IN – input set is used; however, the auxiliary input set, AUX IN + and AUX IN –, can be used if a second input is required. Each input set can be operated in either differential or single-ended modes, since sufficient common-mode range and rejection are provided. The gain for the IN +, IN –, AUX IN +, and AUX IN – inputs can be programmed to be either 1, 2, or 4 (see Table 2). Either input circuit can be selected via software control. It is important to note that a wide dynamic range is assured by the differential internal analog architecture and by the separate analog and digital voltage supplies and grounds.

A/D bandpass filter, A/D bandpass filter clocking, and A/D conversion timing

The A/D bandpass filter can be selected or bypassed via software control. The frequency response of this filter is presented in the following pages. This response results when the switched-capacitor filter clock frequency is 288 kHz. Several possible options can be used to attain a 288-kHz switched-capacitor filter clock. When the filter clock frequency is not 288 kHz, the filter transfer function is frequency-scaled by the ratio of the actual clock frequency to 288 kHz. The low-frequency roll-off of the high-pass section is 300 Hz. However, the high-pass section low-frequency roll-off is less steep for the TLC32042 than for the TLC32040 and TLC32041.

The Internal Timing Configuration and AIC DX Data Word Format sections of this data sheet indicate the many options for attaining a 288-kHz bandpass switched-capacitor filter clock. These sections indicate that the RX Counter A can be programmed to give a 288-kHz bandpass switched-capacitor filter clock for several Master Clock input frequencies.

The A/D conversion rate is then attained by frequency-dividing the 288-kHz bandpass switched-capacitor filter clock with the RX Counter B. Thus, unwanted aliasing is prevented because the A/D conversion rate is an integral submultiple of the bandpass switched-capacitor filter sampling rate, and the two rates are synchronously locked.

A/D converter performance specifications

Fundamental performance specifications for the A/D converter circuitry are presented in the A/D converter operating characteristics section of this data sheet. The realization of the A/D converter circuitry with switched-capacitor techniques provides an inherent sample-and-hold.

analog output

The analog output circuitry is an analog output power amplifier. Both noninverting and inverting amplifier outputs are brought out of the IC. This amplifier can drive transformer hybrids or low-impedance loads directly in either a differential or single-ended configuration.

D/A low-pass filter, D/A low-pass filter clocking, and D/A conversion timing

The frequency response of this filter is presented in the following pages. This response results when the low-pass switched-capacitor filter clock frequency is 288 kHz. Like the A/D filter, the transfer function of this filter is frequency-scaled when the clock frequency is not 288 kHz. A continuous-time filter is provided on the output of the D/A low-pass filter to greatly attenuate any switched-capacitor clock feedthrough.

The D/A conversion rate is then attained by frequency-dividing the 288-kHz switched-capacitor filter clock with TX Counter B. Thus, unwanted aliasing is prevented because the D/A conversion rate is an integral submultiple of the switched-capacitor low-pass filter sampling rate, and the two rates are synchronously locked.

PRINCIPLES OF OPERATION (continued)

asynchronous versus synchronous operation

If the transmit section of the AIC (low-pass filter and DAC) and receive section (bandpass filter and ADC) are operated asynchronously, the low-pass and band-pass filter clocks are independently generated from the Master Clock signal. Also, the D/A and A/D conversion rates are independently determined. If the transmit and receive sections are operated synchronously, the low-pass filter clock drives both low-pass and bandpass filters. In synchronous operation, the A/D conversion timing is derived from, and is equal to, the D/A conversion timing. (See description of the WORD/BYTE pin in the Pin Functional Description Section.)

D/A converter performance specifications

Fundamental performance specifications for the D/A converter circuitry are presented in the D/A converter operating characteristics section of the data sheet. The D/A converter has a sample-and-hold that is realized with a switched-capacitor ladder.

system frequency response correction

Sin x/x correction circuitry is performed in digital signal processor software. The system frequency response can be corrected via DSP software to ± 0.1 dB accuracy to a band-edge of 3000 Hz for all sampling rates. This correction is accomplished with a first-order digital correction filter, which requires only seven TMS320 instruction cycles. With a 200-ns instruction cycle, seven instructions represent an overhead factor of only 1.1% and 1.3% for sampling rates of 8 and 9.6 kHz, respectively (see the sin x/x Correction Section for more details).

serial port

The serial port has four possible modes that are described in detail in the Functional Pin Description Section. These modes are briefly described below and in the Functional Description for Pin 13, WORD/BYTE.

1. The transmit and receive sections are operated asynchronously, and the serial port interfaces directly with the TMS32011 and TMS320C17.
2. The transmit and receive sections are operated asynchronously, and the serial port interfaces directly with the TMS32020 and the TMS320C25.
3. The transmit and receive sections are operated synchronously, and the serial port interfaces directly with the TMS32011 and TMS320C17.
4. The transmit and receive sections are operated synchronously, and the serial port interfaces directly with the TMS32020, TMS320C25, or two SN74299 serial-to-parallel shift registers, which can then interface in parallel to the TMS32010, TMS320C15, to any other digital signal processor, or to external FIFO circuitry.

operation of TLC32040 or TLC32042 with internal voltage reference

The internal reference of the TLC32040 and TLC32042 eliminates the need for an external voltage reference and provides overall circuit cost reduction. Thus, the internal reference eases the design task and provides complete control over the performance of the IC. The internal reference is brought out to a pin and is available to the designer. To keep the amount of noise on the reference signal to a minimum, an external capacitor may be connected between REF and ANLG GND.

**TLC32040C, TLC32040I, TLC32041C, TLC32041I
TLC32042C, TLC32042I
ANALOG INTERFACE CIRCUITS**

PRINCIPLES OF OPERATION (continued)

operation of TLC32040, TLC32041, or TLC32042 with external voltage reference

The REF pin may be driven from an external reference circuit if so desired. This external circuit must be capable of supplying 250 μ A and must be adequately protected from noise such as crosstalk from the analog input.

reset

A reset function is provided to initiate serial communications between the AIC and DSP and to allow fast, cost-effective testing during manufacturing. The reset function will initialize all AIC registers, including the control register. After a negative-going pulse on the RESET pin, the AIC will be initialized. This initialization allows normal serial port communications activity to occur between AIC and DSP (see AIC DX Data Word Format section).

loopback

This feature allows the user to test the circuit remotely. In loopback, the OUT + and OUT – pins are internally connected to the IN + and IN – pins. Thus, the DAC bits (d15 to d2), which are transmitted to the DX pin, can be compared with the ADC bits (d15 to d2), which are received from the DR pin. An ideal comparison would be that the bits on the DR pin equal the bits on the DX pin. However, in practice there will be some difference in these bits due to the ADC and DAC output offsets.

In loopback, if the IN + and IN – pins are enabled, the external signals on the IN + and IN – pins are ignored. If the AUX IN + and AUX IN – pins are enabled, the external signals on these pins are added to the OUT + and OUT – signals in loopback operation.

The loopback feature is implemented with digital signal processor control by transmitting the appropriate serial port bit to the control register (see AIC Data Word Format section).

PIN NAME	NO.	I/O	DESCRIPTION
ANLG GND	17,18		Analog ground return for all internal analog circuits. Not internally connected to DGTL GND.
AUX IN +	24	I	Noninverting auxiliary analog input stage. This input can be switched into the bandpass filter and A/D converter path via software control. If the appropriate bit in the Control register is a 1, the auxiliary inputs will replace the IN + and IN – inputs. If the bit is a 0, the IN + and IN – inputs will be used (see the AIC DX Data Word Format section).
AUX IN –	23	I	Inverting auxiliary analog input (see the above AUX IN + pin description).
DGTL GND	9		Digital ground for all internal logic circuits. Not internally connected to ANLG GND.
DR	5	O	This pin is used to transmit the ADC output bits from the AIC to the TMS320 serial port. This transmission of bits from the AIC to the TMS320 serial port is synchronized with the SHIFT CLK signal.
DX	12	I	This pin is used to receive the DAC input bits and timing and control information from the TMS320. This serial transmission from the TMS320 serial port to the AIC is synchronized with the SHIFT CLK signal.
EODR	3	O	End of Data Receive. See the WORD/BYTE pin description and the Serial Port Timing diagram. During the word-mode timing, this signal is a low-going pulse that occurs immediately after the 16 bits of A/D information have been transmitted from the AIC to the TMS320 serial port. This signal can be used to interrupt a microprocessor upon completion of serial communications. Also, this signal can be used to strobe and enable external serial-to-parallel shift registers, latches, or external FIFO RAM, and to facilitate parallel data bus communications between the AIC and the serial-to-parallel shift registers. During the byte-mode timing, this signal goes low after the first byte has been transmitted from the AIC to the TMS320 serial port and is kept low until the second byte has been transmitted. The TMS32011 or TMS320C17 can use this low-going signal to differentiate between the two bytes as to which is first and which is second. EODR does not occur after secondary communication.

TLC32040C, TLC32040I, TLC32041C, TLC32041I
TLC32042C, TLC32042I
ANALOG INTERFACE CIRCUITS

PIN NAME	NO.	I/O	DESCRIPTION
EODX	11	O	End of Data Transmit. See the WORD/BYTE pin description and the Serial Port Timing diagram. During the word-mode timing, this signal is a low-going pulse that occurs immediately after the 16 bits of D/A converter and control or register information have been transmitted from the TMS320 serial port to the AIC. This signal can be used to interrupt a microprocessor upon the completion of serial communications. Also, this signal can be used to strobe and enable external serial-to-parallel shift registers, latches, or an external FIFO RAM, and to facilitate parallel data-bus communications between the AIC and the serial-to-parallel shift registers. During the byte-mode timing, this signal goes low after the first byte has been transmitted from the TMS320 serial port to the AIC and is kept low until the second byte has been transmitted. The TMS32011 or TMS320C17 can use this low-going signal to differentiate between the two bytes as to which is first and which is second.
FSR	4	O	Frame Sync Receive. In the serial transmission modes, which are described in the WORD/BYTE pin description, the $\overline{\text{FSR}}$ pin is held low during bit transmission. When the $\overline{\text{FSR}}$ pin goes low, the TMS320 serial port will begin receiving bits from the AIC via the DR pin of the AIC. The most significant DR bit will be present on the DR pin before $\overline{\text{FSR}}$ goes low. (See Serial Port Timing and Internal Timing Configuration diagrams.) $\overline{\text{FSR}}$ does not occur after secondary communication.
FSX	14	O	Frame Sync Transmit. When this pin goes low, the TMS320 serial port will begin transmitting bits to the AIC via the DX pin of the AIC. In all serial transmission modes, which are described in the WORD/BYTE pin description, the $\overline{\text{FSX}}$ pin is held low during bit transmission (see Serial Port Timing and Internal Timing Configuration diagrams).
IN +	26	I	Noninverting input to analog input amplifier stage
IN -	25	I	Inverting input to analog input amplifier stage
MSTR CLK	6	I	The Master Clock signal is used to derive all the key logic signals of the AIC, such as the Shift Clock, the switched-capacitor filter clocks, and the A/D and D/A timing signals. The Internal Timing Configuration diagram shows how these key signals are derived. The frequencies of these key signals are synchronous submultiples of the Master Clock frequency to eliminate unwanted aliasing when the sampled analog signals are transferred between the switched-capacitor filters and the A/D and D/A converters (see the Internal Timing Configuration).
OUT +	22	O	Noninverting output of analog output power amplifier. Can drive transformer hybrids or high-impedance loads directly in either a differential or a single-ended configuration.
OUT -	21	O	Inverting output of analog output power amplifier. Functionally identical with and complementary to OUT +.
REF	8	I/O	For the TLC32040 and TLC32042, the internal voltage reference is brought out on this pin. For the TLC32040, TLC32041, and TLC32042, an external voltage reference can be applied to this pin.
RESET	2	I	A reset function is provided to initialize the TA, TA', TB, RA, RA', RB, and control registers. This reset function initiates serial communications between the AIC and DSP. The reset function will initialize all AIC registers including the control register. After a negative-going pulse on the $\overline{\text{RESET}}$ pin, the AIC registers will be initialized to provide an 8-kHz data conversion rate for a 5.184-MHz master clock input signal. The conversion rate adjust registers, TA' and RA', will be reset to 1. The CONTROL register bits will be reset as follows (see AIC DX Data Word Format section). $d7 = 1, d6 = 1, d5 = 1, d4 = 0, d3 = 0, d2 = 1$ This initialization allows normal serial-port communication to occur between AIC and DSP.
SHIFT CLK	10	O	The Shift Clock signal is obtained by dividing the Master Clock signal frequency by four. This signal is used to clock the serial data transfers of the AIC, described in the WORD/BYTE pin description below (see the Serial Port Timing and Internal Timing Configuration diagram).
V _{DD}	7		Digital supply voltage, 5 V \pm 5%
V _{CC} +	20		Positive analog supply voltage, 5 V \pm 5%
V _{CC} -	19		Negative analog supply voltage - 5 V \pm 5%

**TLC32040C, TLC32040I, TLC32041C, TLC32041I
TLC32042C, TLC32042I
ANALOG INTERFACE CIRCUITS**

PIN NAME NO.	I/O	DESCRIPTION
WORD/BYTE 13	I	<p>This pin, in conjunction with a bit in the CONTROL register, is used to establish one of four serial modes. These four serial modes are described below.</p> <p><i>AIC transmit and receive sections are operated asynchronously.</i></p> <p>The following description applies when the AIC is configured to have asynchronous transmit and receive sections. If the appropriate data bit in the Control register is a 0 (see the AIC DX Data Word Format), the transmit and receive sections will be asynchronous.</p> <p>L Serial port directly interfaces with the serial port of the TMS32011 or TMS320C17 and communicates in two 8-bit bytes. The operation sequence is as follows (see Serial Port Timing diagrams).</p> <ol style="list-style-type: none"> 1. The \overline{FSX} or \overline{FSR} pin is brought low. 2. One 8-bit byte is transmitted or one 8-bit byte is received. 3. The \overline{EODX} or \overline{EODR} pin is brought low. 4. The \overline{FSX} or \overline{FSR} pin emits a positive frame-sync pulse that is four Shift Clock cycles wide. 5. One 8-bit byte is transmitted or one 8-bit byte is received. 6. The \overline{EODX} or \overline{EODR} pin is brought high. 7. The \overline{FSX} or \overline{FSR} pin is brought high. <p>H Serial port directly interfaces with the serial port of the TMS32020, TMS320C25, or TMS320C30 and communicates in one 16-bit word. The operation sequence is as follows (see Serial Port Timing diagrams):</p> <ol style="list-style-type: none"> 1. The \overline{FSX} or \overline{FSR} pin is brought low. 2. One 16-bit word is transmitted or one 16-bit word is received. 3. The \overline{FSX} or \overline{FSR} pin is brought high. 4. The \overline{EODX} or \overline{EODR} pin emits a low-going pulse. <p><i>AIC transmit and receive sections are operated synchronously.</i></p> <p>If the appropriate data bit in the Control register is a 1, the transmit and receive sections will be configured to be synchronous. In this case, the bandpass switched-capacitor filter and the A/D conversion timing will be derived from the TX Counter A, TX Counter B, and TA, TA', and TB registers, rather than the RX Counter A, RX Counter B, and RA, RA', and RB registers. In this case, the AIC \overline{FSX} and \overline{FSR} timing will be identical during primary data communication; however, \overline{FSR} will not be asserted during secondary data communication since there is no new A/D conversion result. The synchronous operation sequences are as follows (see Serial Port Timing diagrams).</p> <p>L Serial port directly interfaces with the serial port of the TMS32011 or TMS320C17 and communicates in two 8-bit bytes. The operation sequence is as follows (see Serial Port Timing diagrams):</p> <ol style="list-style-type: none"> 1. The \overline{FSX} and \overline{FSR} pins are brought low. 2. One 8-bit byte is transmitted and one 8-bit byte is received. 3. The \overline{EODX} and \overline{EODR} pins are brought low. 4. The \overline{FSX} and \overline{FSR} pins emit positive frame-sync pulses that are four Shift Clock cycles wide. 5. One 8-bit byte is transmitted and one 8-bit byte is received. 6. The \overline{EODX} and \overline{EODR} pins are brought high. 7. The \overline{FSX} and \overline{FSR} pins are brought high. <p>H Serial port directly interfaces with the serial port of the TMS32020, TMS320C25, or TMS320C30 and communicates in one 16-bit word. The operation sequence is as follows (see Serial Port Timing diagrams):</p> <ol style="list-style-type: none"> 1. The \overline{FSX} and \overline{FSR} pins are brought low. 2. One 16-bit word is transmitted and one 16-bit word is received. 3. The \overline{FSX} and \overline{FSR} pins are brought high. 4. The \overline{EODX} or \overline{EODR} pins emit low-going pulses. <p>Since the transmit and receive sections of the AIC are now synchronous, the AIC serial port, with additional NOR and AND gates, will interface to two SN74299 serial-to-parallel shift registers. Interfacing the AIC to the SN74299 shift register allows the AIC to interface to an external FIFO RAM and facilitates parallel, data bus communications between the AIC and the digital signal processor. The operation sequence is the same as the above sequence (see Serial Port Timing diagrams).</p>

**TLC32040C, TLC32040I, TLC32041C, TLC32041I
TLC32042C, TLC32042I
ANALOG INTERFACE CIRCUITS**

INTERNAL TIMING CONFIGURATION

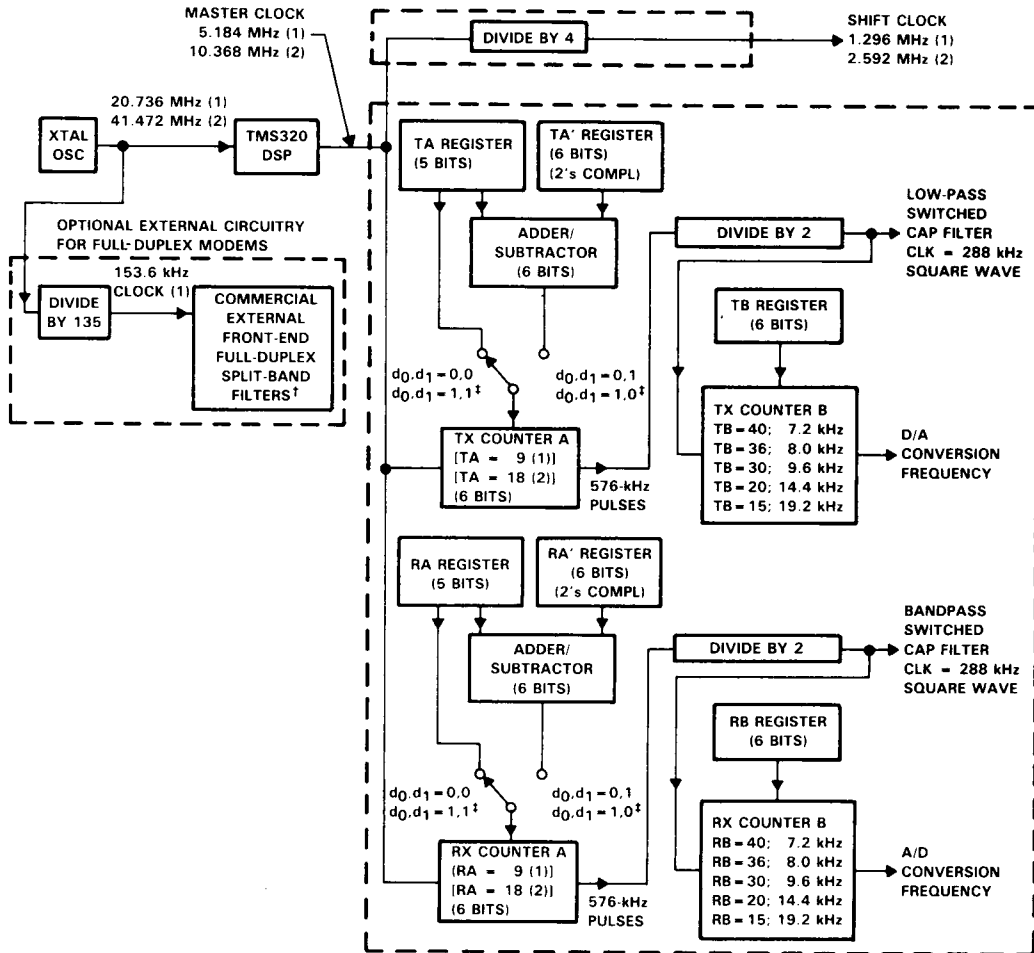

$$\text{SCF Clock Frequency} = \frac{\text{Master Clock Frequency}}{2 \times \text{Contents of Counter A}}$$

NOTE: Frequency 1, 20.736 MHz, is used to show how 153.6 kHz (for a commercially available modem split-band filter clock), popular speech and modem sampling signal frequencies, and an internal 288-kHz switched-capacitor filter clock can be derived synchronously and as submultiples of the crystal oscillator frequency. Since these derived frequencies are synchronous submultiples of the crystal frequency, aliasing does not occur as the sampled analog signal passes between the analog converter and switched-capacitor filter stages. Frequency 2, 41.472 MHz, is used to show that the AIC can work with high-frequency signals, which are used by high-speed digital signal processors.

†Split-band filtering can alternatively be performed after the analog input function via software in the TMS320.

‡These control bits are described in the AIC DX Data Word Format section.

explanation of internal timing configuration

All of the internal timing of the AIC is derived from the high-frequency clock signal that drives the Master Clock input pin. The Shift Clock signal, which strobes the serial port data between the AIC and DSP, is derived by dividing the Master Clock input signal frequency by four.

$$\text{SCF Clock Frequency} = \frac{\text{Master Clock Frequency}}{2 \times \text{Contents of Counter A}}$$

$$\text{Conversion Frequency} = \frac{\text{SCF Clock Frequency}}{\text{Contents of Counter B}}$$

$$\text{Shift Clock Frequency} = \frac{\text{Master Clock Frequency}}{4}$$

TX Counter A and TX Counter B, which are driven by the Master Clock signal, determine the D/A conversion timing. Similarly, RX Counter A and RX Counter B determine the A/D conversion timing. In order for the switched-capacitor low-pass and bandpass filters to meet their transfer function specifications, the frequency of the clock inputs of the switched-capacitor filters must be 288 kHz. If the frequencies of the clock inputs are not 288 kHz, the filter transfer function frequencies are scaled by the ratios of the clock frequencies to 288 kHz. Thus, to obtain the specified filter responses, the combination of Master Clock frequency and TX Counter A and RX Counter A values must yield 288-kHz switched-capacitor clock signals. These 288-kHz clock signals can then be divided by the TX Counter B and RX Counter B to establish the D/A and A/D conversion timings.

TX Counter A and TX Counter B are reloaded every D/A conversion period, while RX Counter A and RX Counter B are reloaded every A/D conversion period. The TX Counter B and RX Counter B are loaded with the values in the TB and RB Registers, respectively. Via software control, the TX Counter A can be loaded with either the TA Register, the TA Register less the TA' Register, or the TA Register plus the TA' Register. By selecting the TA Register less the TA' Register option, the upcoming conversion timing will occur earlier by an amount of time that equals TA' times the signal period of the Master Clock. By selecting the TA Register plus the TA' Register option, the upcoming conversion timing will occur later by an amount of time that equals TA' times the signal period of the Master Clock. Thus, the D/A conversion timing can be advanced or retarded. An identical ability to alter the A/D conversion timing is provided. In this case, however, the RX Counter A can be programmed via software control with the RA Register, the RA Register less the RA' Register, or the RA Register plus the RA' Register.

The ability to advance or retard conversion timing is particularly useful for modem applications. This feature allows controlled changes in the A/D and D/A conversion timing. This feature can be used to enhance signal-to-noise performance, to perform frequency-tracking functions, and to generate nonstandard modem frequencies.

If the transmit and receive sections are configured to be synchronous (see WORD/BYTE pin description), then both the low-pass and bandpass switched-capacitor filter clocks are derived from TX Counter A. Also, both the D/A and A/D conversion timing are derived from the TX Counter A and TX Counter B. When the transmit and receive sections are configured to be asynchronous, the RX Counter A, RX Counter B, RA Register, RA' Register, and RB Registers are not used.

TLC32040C, TLC32040I, TLC32041C, TLC32041I
TLC32042C, TLC32042I
ANALOG INTERFACE CIRCUITS

AIC DR or DX word bit pattern

A/D or D/A MSB,

1st bit sent

1st bit sent of 2nd byte

A/D or D/A LSB

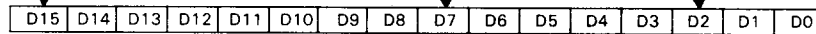

AIC DX data word format section

d15	d14	d13	d12	d11	d10	d9	d8	d7	d6	d5	d4	d2	d1	d0	COMMENTS	
primary DX serial communication protocol																
← d15 (MSB) through d2 go to the D/A converter register													→	0	0	The TX and RX Counter A's are loaded with the TA and RA register values. The TX and RX Counter B's are loaded with TB and RB register values.
← d15 (MSB) through d2 go to the D/A converter register													→	0	1	The TX and RX Counter A's are loaded with the TA + TA' and RA + RA' register values. The TX and RX Counter B's are loaded with the TB and RB register values. NOTE: d1 = 0, d0 = 1 will cause the next D/A and A/D conversion periods to be changed by the addition of TA' and RA' Master Clock cycles, in which TA' and RA' can be positive or negative or zero. Please refer to Table 1. AIC Responses to Improper Conditions.
← d15 (MSB) through d2 go to the D/A converter register													→	1	0	The TX and RX Counter A's are loaded with the TA - TA' and RA - RA' register values. The TX and RX Counter B's are loaded with the TB and RB register values. NOTE: d1 = 1, d0 = 0 will cause the next D/A and A/D conversion periods to be changed by the subtraction of TA' and RA' Master Clock cycles, in which TA' and RA' can be positive or negative or zero. Please refer to Table 1. AIC Responses to Improper Conditions.
← d15 (MSB) through d2 go to the D/A converter register													→	1	1	The TX and RX Counter A's are loaded with the TA and RA register values. The TX and RX Counter B's are loaded with the TB and RB register values. After a delay of four Shift Clock cycles, a secondary transmission will immediately follow to program the AIC to operate in the desired configuration.

NOTE: Setting the two least significant bits to 1 in the normal transmission of DAC information (Primary Communications) to the AIC will initiate Secondary Communications upon completion of the Primary Communications.

Upon completion of the Primary Communication, \overline{FSX} will remain high for four SHIFT CLOCK cycles and will then go low and initiate the Secondary Communication. The timing specifications for the Primary and Secondary Communications are identical. In this manner, the Secondary Communication, if initiated, is interleaved between successive Primary Communications. This interleaving prevents the Secondary Communication from interfering with the Primary Communications and DAC timing, thus preventing the AIC from skipping a DAC output. It is important to note that in the synchronous mode, \overline{FSR} will not be asserted during Secondary Communications.

TLC32040C, TLC32040I, TLC32041C, TLC32041I
TLC32042C, TLC32042I
ANALOG INTERFACE CIRCUITS

secondary DX serial communication protocol

x x ← to TA register → x x ← to RA register → 0 0		d13 and d6 are MSBs (unsigned binary)						
x ← to TA' register → x ← to RA' register → 0 1		d14 and d7 are 2's complement sign bits						
x ← to TB register → x ← to RB register → 1 0		d14 and d7 are MSBs (unsigned binary)						
<table style="margin: auto; border: none;"> <tr> <td style="text-align: center;">x x x x x x x x</td> <td style="text-align: center;">d7 d6 d5 d4 d3 d2</td> <td style="text-align: center;">1 1</td> </tr> <tr> <td colspan="3" style="text-align: center;">← CONTROL REGISTER →</td> </tr> </table>	x x x x x x x x	d7 d6 d5 d4 d3 d2	1 1	← CONTROL REGISTER →				d2 = 0/1 deletes/inserts the bandpass filter d3 = 0/1 disables/enables the loopback function d4 = 0/1 disables/enables the AUX IN+ and AUX IN- pins d5 = 0/1 asynchronous/synchronous transmit and receive sections d6 = 0/1 gain control bits (see Gain Control Section) d7 = 0/1 gain control bits (see Gain Control Section)
x x x x x x x x	d7 d6 d5 d4 d3 d2	1 1						
← CONTROL REGISTER →								

reset function

A reset function is provided to initiate serial communications between the AIC and DSP. The reset function will initialize all AIC registers, including the control register. After power has been applied to the AIC, a negative-going pulse on the RESET pin will initialize the AIC registers to provide an 8-kHz A/D and D/A conversion rate for a 5.184 MHz master clock input signal. The AIC, excepting the CONTROL register, will be initialized as follows (see AIC DX Data Word Format section):

<u>REGISTER</u>	<u>INITIALIZED REGISTER VALUE (HEX)</u>
TA	9
TA'	1
TB	24
RA	9
RA'	1
RB	24

The CONTROL register bits will be reset as follows (see AIC DX Data Word Format section):

d7 = 1, d6 = 1, d5 = 1, d4 = 0, d3 = 0, d2 = 1

This initialization allows normal serial port communications to occur between AIC and DSP. If the transmit and receive sections are configured to operate synchronously and the user wishes to program different conversion rates, only the TA, TA', and TB register need to be programmed, since both transmit and receive timing are synchronously derived from these registers (see the Pin Descriptions and AIC DX Word Format sections).

The circuit shown below will provide a reset on power-up when power is applied in the sequence given under Power-Up Sequence. The circuit depends on the power supplies' reaching their recommended values a minimum of 800 ns before the capacitor charges to 0.8 V above DGTL GND.

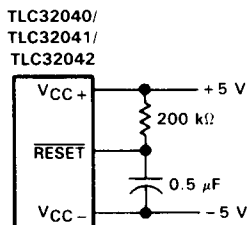

**TLC32040C, TLC32040I, TLC32041C, TLC32041I
TLC32042C, TLC32042I
ANALOG INTERFACE CIRCUITS**

power-up sequence

To ensure proper operation of the AIC, and as a safeguard against latch-up, it is recommended that a Schottky diode with a forward voltage less than or equal to 0.4 V be connected from VCC – to ANLG GND (see Figure 17). In the absence of such a diode, power should be applied in the following sequence: ANLG GND and DGTL GND, VCC –, then VCC + and VDD. Also, no input signal should be applied until after power-up.

AIC responses to improper conditions

The AIC has provisions for responding to improper conditions. These improper conditions and the response of the AIC to these conditions are presented in Table 1 below.

AIC register constraints

The following constraints are placed on the contents of the AIC registers:

1. TA register must be ≥ 4 in word mode (WORD/BYTE = High).
2. TA register must be ≥ 5 in byte mode (WORD/BYTE = Low).
3. TA' register can be either positive, negative, or zero.
4. RA register must be ≥ 4 in word mode (WORD/BYTE = High).
5. RA register must be ≥ 5 in byte mode (WORD/BYTE = Low).
6. RA' register can be either positive, negative, or zero.
7. (TA register \pm TA' register) must be > 1 .
8. (RA register \pm RA' register) must be > 1 .
9. TB register must be > 1 .

TABLE 1. AIC RESPONSES TO IMPROPER CONDITIONS

IMPROPER CONDITION	AIC RESPONSE
TA register + TA' register = 0 or 1 TA register – TA' register = 0 or 1	Reprogram TX Counter A with TA register value
TA register + TA' register < 0	MODULO 64 arithmetic is used to ensure that a positive value is loaded into the TX Counter A, i.e., TA register + TA' register + 40 HEX is loaded into TX Counter A.
RA register + RA' register = 0 or 1 RA register – RA' register = 0 or 1	Reprogram RX Counter A with RA register value
RA register + RA' register = 0 or 1	MODULO 64 arithmetic is used to ensure that a positive value is loaded into RX Counter A, i.e., RA register + RA' register + 40 HEX is loaded into RX Counter A.
TA register = 0 or 1 RA register = 0 or 1	AIC is shut down.
TA register < 4 in word mode TA register < 5 in byte mode RA register < 4 in word mode RA register < 5 in byte mode	The AIC serial port no longer operates.
TB register = 0 or 1	Reprogram TB register with 24 HEX
RB register = 0 or 1	Reprogram RB register with 24 HEX
AIC and DSP cannot communicate	Hold last DAC output

improper operation due to conversion times being too close together

If the difference between two successive D/A conversion frame syncs is less than 1/19.2 kHz, the AIC operates improperly. In this situation, the second D/A conversion frame sync occurs too quickly and there is not enough time for the ongoing conversion to be completed. This situation can occur if the A and B registers are improperly programmed or if the A + A' register or A – A' register result is too small. When incrementally adjusting the conversion period via the A + A' register options, the designer should be very careful not to violate this requirement (see following diagram).

**TLC32040C, TLC32040I, TLC32041C, TLC32041I
TLC32042C, TLC32042I
ANALOG INTERFACE CIRCUITS**

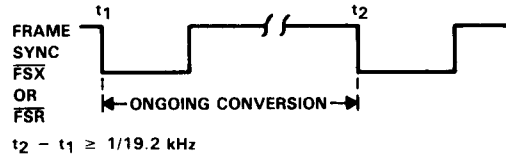

asynchronous operation — more than one receive frame sync occurring between two transmit frame syncs

When incrementally adjusting the conversion period via the $A + A'$ or $A - A'$ register options, a specific protocol is followed. The command to use the incremental conversion period adjust option is sent to the AIC during a $\overline{\text{FSX}}$ frame sync. The ongoing conversion period is then adjusted. However, either Receive Conversion Period A or B may be adjusted. For both transmit and receive conversion periods, the incremental conversion period adjustment is performed near the end of the conversion period. Therefore, if there is sufficient time between t_1 and t_2 , the receive conversion period adjustment will be performed during Receive Conversion Period A. Otherwise, the adjustment will be performed during Receive Conversion Period B. The adjustment command only adjusts one transmit conversion period and one receive conversion period. To adjust another pair of transmit and receive conversion periods, another command must be issued during a subsequent $\overline{\text{FSX}}$ frame (see figure below).

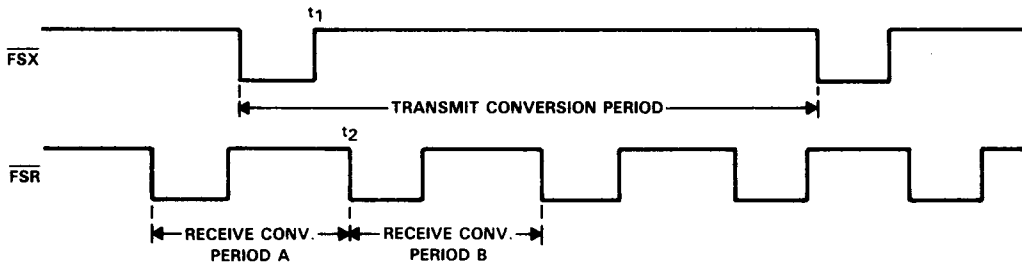

asynchronous operation — more than one transmit frame sync occurring between two receive frame syncs

When incrementally adjusting the conversion period via the $A + A'$ or $A - A'$ register options, a specific protocol is followed. For both transmit and receive conversion periods, the incremental conversion period adjustment is performed near the end of the conversion period. The command to use the incremental conversion period adjust options is sent to the AIC during a $\overline{\text{FSX}}$ frame sync. The ongoing transmit conversion period is then adjusted. However, three possibilities exist for the receive conversion period adjustment in the diagram as shown in the following figure. If the adjustment command is issued during Transmit Conversion Period A, Receive Conversion Period A will be adjusted if there is sufficient time between t_1 and t_2 . Or, if there is not sufficient time between t_1 and t_2 , Receive Conversion Period B will be adjusted. Or, the receive portion of an adjustment command may be ignored if the adjustment command is sent during a receive conversion period, which is already being or will be adjusted due to a prior adjustment command. For example, if adjustment commands are issued during Transmit Conversion Periods A, B, and C, the first two commands may cause Receive Conversion Periods A and B to be adjusted, while the third receive adjustment command is ignored. The third adjustment command is ignored since it was issued during Receive Conversion Period B, which already will be adjusted via the Transmit Conversion Period B adjustment command.

**TLC32040C, TLC32040I, TLC32041C, TLC32041I
TLC32042C, TLC32042I
ANALOG INTERFACE CIRCUITS**

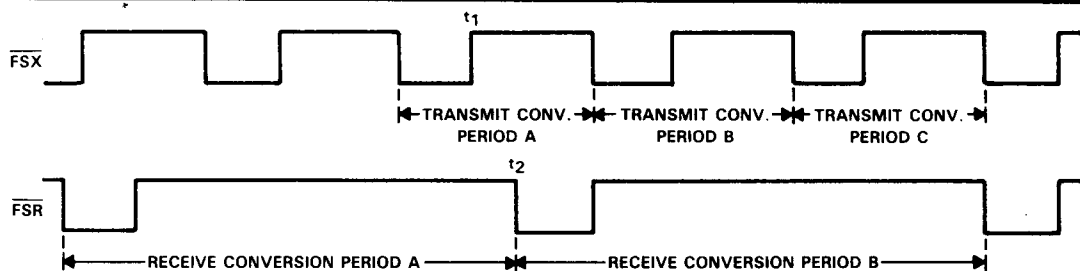

asynchronous operation — more than one set of primary and secondary DX serial communication occurring between two receive frame sync (see AIC DX Data Word Format section)

The TA, TA', TB, and control register information that is transmitted in the secondary communications is always accepted and is applied during the ongoing transmit conversion period. If there is sufficient time between t1 and t2, the TA, RA', and RB register information, which is sent during Transmit Conversion Period A, will be applied to Receive Conversion Period A. Otherwise, this information will be applied during Receive Conversion Period B. If RA, RA', and RB register information has already been received and is being applied during an ongoing conversion period, any subsequent RA, RA', or RB information that is received during this receive conversion period will be disregarded (see diagram below).

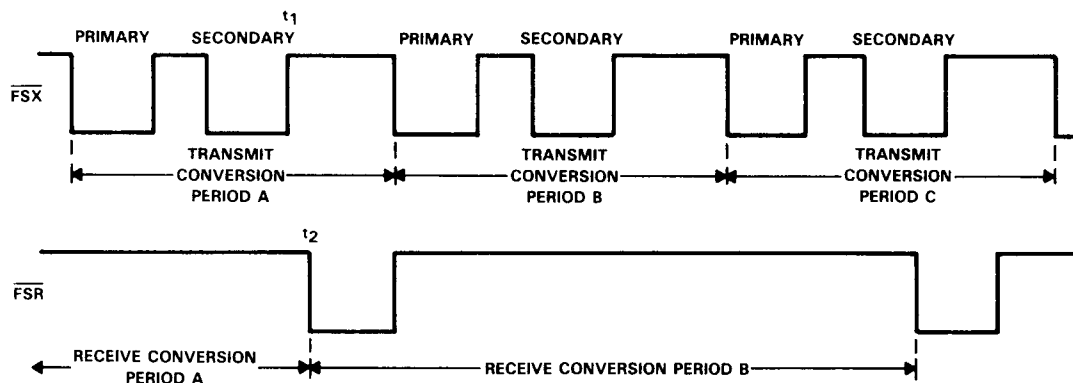

absolute maximum ratings over operating free-air temperature range (unless otherwise noted)

Supply voltage range, V_{CC+} (see Note 1)	-0.3 V to 15 V
Supply voltage range, V_{DD}	-0.3 V to 15 V
Output voltage range, V_O	-0.3 V to 15 V
Input voltage range, V_I	-0.3 V to 15 V
Digital ground voltage range	-0.3 V to 15 V
Operating free-air temperature range: TLC32040C, TLC32041C, TLC32042C	0°C to 70°C
TLC32040I, TLC32041I, TLC32042I	-40°C to 85°C
Storage temperature range	-40°C to 125°C
Case temperature for 10 seconds: FN package	260°C
Lead temperature 1,6 mm (1/16 inch) from case for 10 seconds: N package	260°C

NOTE 1: Voltage values for maximum ratings are with respect to V_{CC-} .



**TLC32040C, TLC32040I, TLC32041C, TLC32041I
TLC32042C, TLC32042I
ANALOG INTERFACE CIRCUITS**

recommended operating conditions

PARAMETER	MIN	NOM	MAX	UNIT
Supply voltage, V_{CC+} (see Note 2)	4.75	5	5.25	V
Supply voltage, V_{CC-} (see Note 2)	-4.75	-5	-5.25	V
Digital supply voltage, V_{DD} (see Note 2)	4.75	5	5.25	V
Digital ground voltage with respect to ANLG GND, DGTL GND		0		V
Reference input voltage, $V_{ref(ext)}$ (see Note 2)	2		4	V
High-level input voltage, V_{IH}	2	$V_{DD} + 0.3$		V
Low-level input voltage, V_{IL} (see Note 3)	-0.3		0.8	V
Load resistance at OUT+ and/or OUT-, R_L	300			Ω
Load capacitance at OUT+ and/or OUT-, C_L			100	pF
MSTR CLK frequency (see Note 4)	0.075	5	10.368	MHz
Analog input amplifier common mode input voltage (see Note 5)			± 1.5	V
A/D or D/A conversion rate			20	kHz
Operating free-air temperature, T_A	TLC32040C, TLC32041C, TLC32042C	0	70	$^{\circ}\text{C}$
	TLC32040I, TLC32041I, TLC32042I	-40	85	

- NOTES: 2. Voltages at analog inputs and outputs, REF, V_{CC+} , and V_{CC-} , are with respect to the ANLG GND terminal. Voltages at digital inputs and outputs and V_{DD} are with respect to the DGTL GND terminal.
3. The algebraic convention, in which the least positive (most negative) value is designated minimum, is used in this data sheet for logic voltage levels and temperature only.
4. The bandpass and low-pass switched-capacitor filter response specifications apply only when the switched-capacitor clock frequency is 288 kHz. For switched-capacitor filter clocks at frequencies other than 288 kHz, the filter response is shifted by the ratio of switched-capacitor filter clock frequency to 288 kHz.
5. This range applies when $(IN+ - IN-)$ or $(AUX IN+ - AUX IN-)$ equals ± 6 V.

TLC32040C, TLC32040I, TLC32041C, TLC32041I
TLC32042C, TLC32042I
ANALOG INTERFACE CIRCUITS

electrical characteristics over recommended operating free-air temperature range, $V_{CC+} = 5\text{ V}$, $V_{CC-} = -5\text{ V}$, $V_{DD} = 5\text{ V}$ (unless otherwise noted)

total device, MSTR CLK frequency = 5.184 MHz, outputs not loaded

PARAMETER		TEST CONDITIONS	MIN	TYP [†]	MAX	UNIT
V_{OH}	High-level output voltage	$V_{DD} = 4.75\text{ V}$, $I_{OH} = -300\text{ }\mu\text{A}$	2.4			V
V_{OL}	Low-level output voltage	$V_{DD} = 4.75\text{ V}$, $I_{OL} = 2\text{ mA}$			0.4	V
I_{CC+}	Supply current from V_{CC+}	TLC3204-C			35	mA
		TLC3204-I			40	
I_{CC-}	Supply current from V_{CC-}	TLC3204-C			-35	mA
		TLC3204-I			-40	
I_{DD}	Supply current from V_{DD}	$f_{MSTR\ CLK} = 5.184\text{ MHz}$			7	mA
V_{ref}	Internal reference output voltage		3		3.3	V
αV_{ref}	Temperature coefficient of internal reference voltage			200		ppm/°C
r_o	Output resistance at REF			100		k Ω

receive amplifier input

PARAMETER		TEST CONDITIONS	MIN	TYP [†]	MAX	UNIT
	A/D converter offset error (filters bypassed)			25	65	mV
	A/D converter offset error (filters in)			25	65	mV
CMRR	Common-mode rejection ratio at IN+, IN-, or AUX IN+, AUX IN-	See Note 6		55		dB
r_i	Input resistance at IN+, IN-, or AUX IN+, AUX IN-, REF			100		k Ω

transmit filter output

PARAMETER		TEST CONDITIONS	MIN	TYP [†]	MAX	UNIT
V_{OO}	Output offset voltage at OUT+ or OUT- (single-ended relative to ANLG GND)			15	75	mV
V_{OM}	Maximum peak output voltage swing across R_L at OUT+ or OUT- (single-ended)	$R_L \geq 300\text{ }\Omega$, Offset voltage = 0		± 3		V
V_{OM}	Maximum peak output voltage swing between OUT+ and OUT- (differential output)	$R_L \geq 600\text{ }\Omega$		± 6		V

[†]All typical values are at $T_A = 25\text{ }^\circ\text{C}$.

NOTE 6: The test condition is a 0-dBm, 1-kHz input signal with an 8-kHz conversion rate.

**TLC32040C, TLC32040I, TLC32041C, TLC32041I
TLC32042C, TLC32042I
ANALOG INTERFACE CIRCUITS**

electrical characteristics over recommended operating free-air temperature range, $V_{CC+} = 5\text{ V}$, $V_{CC-} = -5\text{ V}$, $V_{DD} = 5\text{ V}$ (unless otherwise noted) (continued)

system distortion specifications, SCF clock frequency = 288 kHz

PARAMETER		TEST CONDITIONS	MIN	TYP [†]	MAX	UNIT
Attenuation of second harmonic of A/D input signal	single-ended	$V_{in} = -0.5\text{ dB to } -24\text{ dB}$ referred to V_{ref} . See Note 7		70		dB
	differential		62	70		
Attenuation of third and higher harmonics of A/D input signal	single-ended	$V_{in} = -0.5\text{ dB to } -24\text{ dB}$ referred to V_{ref} . See Note 7		65		dB
	differential		57	65		
Attenuation of second harmonic of D/A input signal	single-ended	$V_{in} = -0\text{ dB to } -24\text{ dB}$ referred to V_{ref} . See Note 7		70		dB
	differential		62	70		
Attenuation of third and higher harmonics of D/A input signal	single-ended	$V_{in} = -0\text{ dB to } -24\text{ dB}$ referred to V_{ref} . See Note 7		65		dB
	differential		57	65		

A/D channel signal-to-distortion ratio

PARAMETER	TEST CONDITIONS (see Note 7)	$A_V = 1^\ddagger$		$A_V = 2^\ddagger$		$A_V = 4^\ddagger$		UNIT
		MIN	MAX	MIN	MAX	MIN	MAX	
A/D channel signal-to-distortion ratio	$V_{in} = -6\text{ dB to } -0.1\text{ dB}$	58		$> 58^\S$		$> 58^\S$		dB
	$V_{in} = -12\text{ dB to } -6\text{ dB}$	58		58		$> 58^\S$		
	$V_{in} = -18\text{ dB to } -12\text{ dB}$	56		58		58		
	$V_{in} = -24\text{ dB to } -18\text{ dB}$	50		56		58		
	$V_{in} = -30\text{ dB to } -24\text{ dB}$	44		50		56		
	$V_{in} = -36\text{ dB to } -30\text{ dB}$	38		44		50		
	$V_{in} = -42\text{ dB to } -36\text{ dB}$	32		38		44		
	$V_{in} = -48\text{ dB to } -42\text{ dB}$	26		32		38		
$V_{in} = -54\text{ dB to } -48\text{ dB}$	20		26		32			

D/A channel signal-to-distortion ratio

PARAMETER	TEST CONDITIONS (see Note 7)	MIN	MAX	UNIT
D/A channel signal-to-distortion ratio	$V_{in} = -6\text{ dB to } 0\text{ dB}$	58		dB
	$V_{in} = -12\text{ dB to } -6\text{ dB}$	58		
	$V_{in} = -18\text{ dB to } -12\text{ dB}$	56		
	$V_{in} = -24\text{ dB to } -18\text{ dB}$	50		
	$V_{in} = -30\text{ dB to } -24\text{ dB}$	44		
	$V_{in} = -36\text{ dB to } -30\text{ dB}$	38		
	$V_{in} = -42\text{ dB to } -36\text{ dB}$	32		
	$V_{in} = -48\text{ dB to } -42\text{ dB}$	26		
$V_{in} = -54\text{ dB to } -48\text{ dB}$	20			

[†]All typical values are at $T_A = 25^\circ\text{C}$.

[‡] A_V is the programmable gain of the input amplifier.

[§]A value > 58 is overrange and signal clipping occurs.

NOTE 7: The test condition is a 1-kHz input signal with an 8-kHz conversion rate (0 dB relative to V_{ref}). The load impedance for the DAC is 600 Ω .

**TLC32040C, TLC32040I, TLC32041C, TLC32041I
TLC32042C, TLC32042I
ANALOG INTERFACE CIRCUITS**

gain and dynamic range

PARAMETER	TEST CONDITIONS	MIN	TYP [†]	MAX	UNIT
Absolute transmit gain tracking error while transmitting into 600 Ω	-48 dB to 0 dB signal range, See Note 8		± 0.05	± 0.15	dB
Absolute receive gain tracking error	-48 dB to 0 dB signal range, See Note 8		± 0.05	± 0.15	dB
Absolute gain of the A/D channel	Signal input is a -0.5-dB, 1-kHz sine wave		0.2		dB
Absolute gain of the D/A channel	Signal input is a 0-dB, 1-kHz sine wave		-0.3		dB

[†]All typical values are at $T_A = 25^\circ\text{C}$.

NOTE 8: Gain tracking is relative to the absolute gain at 1 kHz and 0 dB (0 dB relative to V_{ref}).

power supply rejection and crosstalk attenuation

PARAMETER	TEST CONDITIONS	MIN	TYP [†]	MAX	UNIT
V_{CC+} or V_{CC-} supply voltage rejection ratio, receive channel	$f = 0$ to 30 kHz		30		dB
	$f = 30$ kHz to 50 kHz		45		
V_{CC+} or V_{CC-} supply voltage rejection ratio, transmit channel (single-ended)	$f = 0$ to 30 kHz		30		dB
	$f = 30$ kHz to 50 kHz		45		
Crosstalk attenuation, transmit-to-receive (single-ended)			80		dB

TLC32040C, TLC32040I, TLC32041C, TLC32041I
TLC32042C, TLC32042I
ANALOG INTERFACE CIRCUITS

delay distortion, SCF clock frequency = 288 kHz \pm 2%, input (IN+ – IN–) is \pm 3-V sinewave

Please refer to filter response graphs for delay distortion specifications.

TLC32040 and TLC32041 bandpass filter transfer function (see curves), SCF clock frequency = 288 kHz \pm 2%, input (IN+ – IN–) is a \pm 3-V sinewave (see Note 9)

PARAMETER	TEST CONDITIONS	MIN	MAX	UNIT	
Filter Gain (see Note 10)	Input signal reference is 0 dB	f = 100 Hz		-42	dB
		f = 170 Hz		-25	
		300 Hz \leq f \leq 3.4 kHz	-0.5	0.5	
		f = 4 kHz		-16	
		f \geq 4.6 kHz		-58	

TLC32042 bandpass filter transfer function (see curves), SCF clock frequency = 288 kHz \pm 2%, input (IN+ – IN–) is a \pm 3-V sinewave (see Note 9)

PARAMETER	TEST CONDITIONS	MIN	MAX	UNIT	
Filter Gain (see Note 10)	Input signal reference is 0 dB	f = 100 Hz		-27	dB
		f = 170 Hz		-2	
		300 Hz \leq f \leq 3.4 kHz	-0.5	0.5	
		f = 4 kHz		-16	
		f \geq 4.6 kHz		-58	

low-pass filter transfer function, SCF clock frequency = 288 kHz \pm 2% (see Note 9)

PARAMETER	TEST CONDITIONS	MIN	MAX	UNIT	
Filter Gain (see Note 10)	Output signal reference is 0 dB	f \leq 3.4 kHz	-0.5	0.5	dB
		f = 3.6 kHz		-4	
		f = 4 kHz		-30	
		f \geq 4.4 kHz		-58	

serial port

PARAMETER	TEST CONDITIONS	MIN	TYP [†]	MAX	UNIT
V _{OH} High-level output voltage	I _{OH} = -300 μ A	2.4			V
V _{OL} Low-level output voltage	I _{OL} = 2 mA			0.4	V
I _I Input current				\pm 10	μ A
C _I Input capacitance			15		pF
C _O Output capacitance			15		pF

[†] All typical values are at T_A = 25°C.

NOTES: 9. The above filter specifications are for a switched-capacitor filter clock range of 288 kHz \pm 2%. For switched-capacitor filter clocks at frequencies other than 288 kHz \pm 2%, the filter response is shifted by the ratio of switched-capacitor filter clock frequency to 288 kHz.

10. The filter gain outside of the passband is measured with respect to the gain at 1 kHz. The filter gain within the passband is measured with respect to the average gain within the passband. The passbands are 300 to 3400 Hz and 0 to 3400 Hz for the bandpass and lowpass filters respectively.

TLC32040C, TLC32040I, TLC32041C, TLC32041I
TLC32042C, TLC32042I
ANALOG INTERFACE CIRCUITS

operating characteristics over recommended operating free-air temperature range, $V_{CC+} = 5\text{ V}$,
 $V_{CC-} = -5\text{ V}$, $V_{DD} = 5\text{ V}$

noise (measurement includes low-pass and bandpass switched-capacitor filters)

PARAMETER		TEST CONDITIONS	TYP†	MAX	UNIT
Transmit noise	single-ended	DX input = 00000000000000, constant input code	200		$\mu\text{V rms}$
	differential		300	500	$\mu\text{V rms}$
				20	
Receive noise (see Note 11)		Inputs grounded, gain = 1	300	475	$\mu\text{V rms}$
			20		dBrnc0

timing requirements

serial port recommended input signals

PARAMETER		MIN	MAX	UNIT
$t_c(\text{MCLK})$	Master clock cycle time	95		ns
$t_r(\text{MCLK})$	Master clock rise time		10	ns
$t_f(\text{MCLK})$	Master clock fall time		10	ns
	Master clock duty cycle	42%	58%	
	RESET pulse duration (see Note 12)	800		ns
$t_{su}(\text{DX})$	DX setup time before SCLK↓	20		ns
$t_h(\text{DX})$	DX hold time after SCLK↓		$t_c(\text{SCLK})/4$	ns

- NOTES: 11. This noise is referred to the input with a buffer gain of one. If the buffer gain is two or four, the noise figure will be correspondingly reduced. The noise is computed by statistically evaluating the digital output of the A/D converter.
12. RESET pulse duration is the amount of time that the reset pin is held below 0.8 V after the power supplies have reached their recommended values.

serial port—AIC output signals, $C_L = 30\text{ pF}$ for SHIFT CLK output, $C_L = 15\text{ pF}$ for all other outputs

PARAMETER		MIN	TYP†	MAX	UNIT
$t_c(\text{SCLK})$	Shift clock (SCLK) cycle time	380			ns
$t_f(\text{SCLK})$	Shift clock (SCLK) fall time		3	8	ns
$t_r(\text{SCLK})$	Shift clock (SCLK) rise time		3	8	ns
	Shift clock (SCLK) duty cycle	45		55	%
$t_d(\text{CH-FL})$	Delay from SCLK↑ to FSR/FSX/FSD↓		30		ns
$t_d(\text{CH-FH})$	Delay from SCLK↑ to FSR/FSX/FSD↑		35	90	ns
$t_d(\text{CH-DR})$	DR valid after SCLK↑			90	ns
$t_{dw}(\text{CH-EL})$	Delay from SCLK↑ to EODX/EODR↑ in word mode			90	ns
$t_{dw}(\text{CH-EH})$	Delay from SCLK↑ to EODX/EODR↑ in word mode			90	ns
$t_f(\text{EODX})$	EODX fall time		2	8	ns
$t_f(\text{EODR})$	EODR fall time		2	8	ns
$t_{db}(\text{CH-EL})$	Delay from SCLK↑ to EODX/EODR↑ in byte mode			90	ns
$t_{db}(\text{CH-EH})$	Delay from SCLK↑ to EODX/EODR↑ in byte mode			90	ns
$t_d(\text{MH-SL})$	Delay from MSTR CLK↑ to SCLK↑		65	170	ns
$t_d(\text{MH-SH})$	Delay from MSTR CLK↑ to SCLK↑		65	170	ns

†Typical values are at $T_A = 25^\circ\text{C}$.

TLC32040C, TLC32040I, TLC32041C, TLC32041I
TLC32042C, TLC32042I
ANALOG INTERFACE CIRCUITS

operating characteristics over recommended operating free-air temperature range, $V_{CC+} = 5\text{ V}$, $V_{CC-} = -5\text{ V}$, $V_{DD} = 5\text{ V}$ (continued)

serial port — AIC output signals

PARAMETER	TEST CONDITIONS	MIN	TYP†	MAX	UNIT
$t_c(\text{SCLK})$	Shift clock (SCLK) cycle time		380		ns
$t_f(\text{SCLK})$	Shift clock (SCLK) fall time			50	ns
$t_r(\text{SCLK})$	Shift clock (SCLK) rise time			50	ns
	Shift clock (SCLK) duty cycle		45	55	%
$t_d(\text{CH-FL})$	Delay from SCLK↑ to FSR/FSX↓	$C_L = 50\text{ pF}$		52	ns
$t_d(\text{CH-FH})$	Delay from SCLK↑ to FSR/FSX↑	$C_L = 50\text{ pF}$		52	ns
$t_d(\text{CH-DR})$	DR valid after SCLK↑			90	ns
$t_{dw}(\text{CH-EL})$	Delay from SCLK↑ to $\overline{\text{EODX}}/\overline{\text{EODR}}↓$ in word mode			90	ns
$t_{dw}(\text{CH-EH})$	Delay from SCLK↑ to $\overline{\text{EODX}}/\overline{\text{EODR}}↑$ in word mode			90	ns
$t_f(\text{EODX})$	$\overline{\text{EODX}}$ fall time			15	ns
$t_f(\text{EODR})$	$\overline{\text{EODR}}$ fall time			15	ns
$t_{db}(\text{CH-EL})$	Delay from SCLK↑ to $\overline{\text{EODX}}/\overline{\text{EODR}}↓$ in byte mode			100	ns
$t_{db}(\text{CH-EH})$	Delay from SCLK↑ to $\overline{\text{EODX}}/\overline{\text{EODR}}↑$ in byte mode			100	ns
$t_d(\text{MH-SL})$	Delay from MSTR CLK↑ to SCLK↑		65		ns
$t_d(\text{MH-SH})$	Delay from MSTR CLK↑ to SCLK↓		65		ns

†Typical values are at $T_A \approx 25^\circ\text{C}$.

TABLE 2. GAIN CONTROL TABLE
(ANALOG INPUT SIGNAL REQUIRED FOR FULL-SCALE A/D CONVERSION)

INPUT CONFIGURATIONS	CONTROL REGISTER BITS		ANALOG INPUT†	A/D CONVERSION RESULT
	d6	d7		
Differential configuration	1	1	$\pm 6\text{ V}$	full-scale
Analogue input = $\text{IN}+ - \text{IN}-$	0	0		
= $\text{AUX IN}+ - \text{AUX IN}-$	1	0	$\pm 3\text{ V}$	full-scale
	0	1	$\pm 1.5\text{ V}$	full-scale
Single-ended configuration	1	1	$\pm 3\text{ V}$	half-scale
Analogue input = $\text{IN}+ - \text{ANLG GND}$	0	0		
= $\text{AUX IN}+ - \text{ANLG GND}$	1	0	$\pm 3\text{ V}$	full-scale
	0	1	$\pm 1.5\text{ V}$	full-scale

†In this example, V_{ref} is assumed to be 3 V. In order to minimize distortion, it is recommended that the analog input not exceed 0.1 dB below full scale.

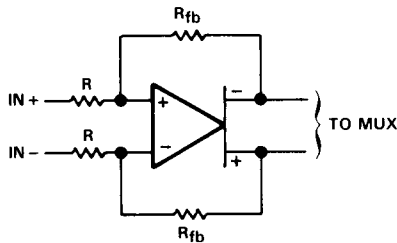

$$R_{fb} = R \text{ for } d6 = 1, d7 = 1$$

$$d6 = 0, d7 = 0$$

$$R_{fb} = 2R \text{ for } d6 = 1, d7 = 0$$

$$R_{fb} = 4R \text{ for } d6 = 0, d7 = 1$$

FIGURE 1. $\text{IN}+$ AND $\text{IN}-$ GAIN CONTROL CIRCUITRY

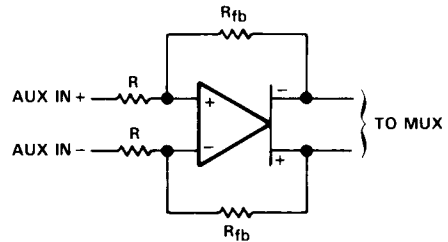

$$R_{fb} = R \text{ for } d6 = 1, d7 = 1$$

$$d6 = 0, d7 = 0$$

$$R_{fb} = 2R \text{ for } d6 = 1, d7 = 0$$

$$R_{fb} = 4R \text{ for } d6 = 0, d7 = 1$$

FIGURE 2. $\text{AUX IN}+$ AND $\text{AUX IN}-$ GAIN CONTROL CIRCUITRY

**TLC32040C, TLC32040I, TLC32041C, TLC32041I
TLC32042C, TLC32042I
ANALOG INTERFACE CIRCUITS**

sin x/x correction section

The AIC does not have sin x/x correction circuitry after the digital-to-analog converter. Sin x/x correction can be accomplished easily and efficiently in digital signal processor (DSP) software. Excellent correction accuracy can be achieved to a band edge of 3000 Hz by using a first-order digital correction filter. The results, which are shown below, are typical of the numerical correction accuracy that can be achieved for sample rates of interest. The filter requires only seven instruction cycles per sample on the TMS320 DSPs. With a 200-ns instruction cycle, nine instructions per sample represents an overhead factor of 1.4% and 1.7% for sampling rates of 8000 Hz and 9600 Hz, respectively. This correction will add a slight amount of group delay at the upper edge of the 300–3000-Hz band.

sin x/x roll-off for a zero-order hold function

The sin x/x roll-off for the AIC DAC zero-order hold function at a band-edge frequency of 3000 Hz for the various sampling rates is shown in the table below.

TABLE 3. sin x/x ROLL-OFF

f_s (Hz)	$20 \log \frac{\sin \pi f/f_s}{\pi f/f_s}$ ($f = 3000$ Hz) (dB)
7200	-2.64
8000	-2.11
9600	-1.44
14400	-0.63
19200	-0.35

Note that the actual AIC sin x/x roll-off will be slightly less than the above figures, because the AIC has less than a 100-% duty cycle hold interval.

correction filter

To compensate for the sin x/x roll-off of the AIC, a first-order correction filter shown below, is recommended.

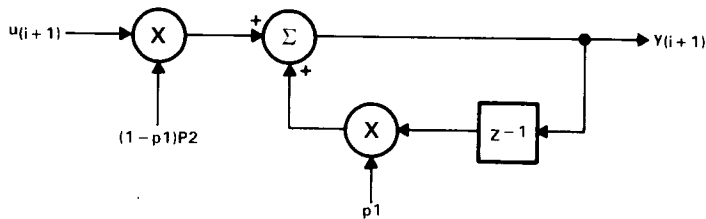

The difference equation for this correction filter is:

$$y_{i+1} = p_2(1 - p_1) (u_{i+1}) + p_1 y_i$$

where the constant p1 determines the pole locations.

The resulting squared magnitude transfer function is:

$$|H(f)|^2 = \frac{p_2^2 (1 - p_1)^2}{1 - 2p_1 \cos(2 \pi f/f_s) + p_1^2}$$

correction results

Table 4 below shows the optimum p values and the corresponding correction results for 8000-Hz and 9600-Hz sampling rates.

TABLE 4

f (Hz)	ERROR (dB)	ERROR (dB)
	f _s = 8000 Hz p1 = -0.14813 p2 = 0.9888	f _s = 9600 Hz p1 = -0.1307 p2 = 0.9951
300	-0.099	-0.043
600	-0.089	-0.043
900	-0.054	0
1200	-0.002	0
1500	0.041	0
1800	0.079	0.043
2100	0.100	0.043
2400	0.091	0.043
2700	-0.043	0
3000	-0.102	-0.043

TMS320 software requirements

The digital correction filter equation can be written in state variable form as follows:

$$Y = k1Y + k2U$$

where k1 equals p1 (from the preceding page), k2 equals (1 - p1)p2 (from the preceding page), Y is the filter state, and U is the next I/O sample. The coefficients k1 and k2 must be represented as 16-bit integers. The SACH instruction (with the proper shift) will yield the correct result. With the assumption that the TMS320 processor page pointer and memory configuration are properly initialized, the equation can be executed in seven instructions or seven cycles with the following program:

```
ZAC
LT K2
MPY U
LTA K1
MPY Y
APAC
SACH (dma), (shift)
```

TLC32040C, TLC32040I, TLC32041C, TLC32041I
 TLC32042C, TLC32042I
 ANALOG INTERFACE CIRCUITS

byte-mode timing

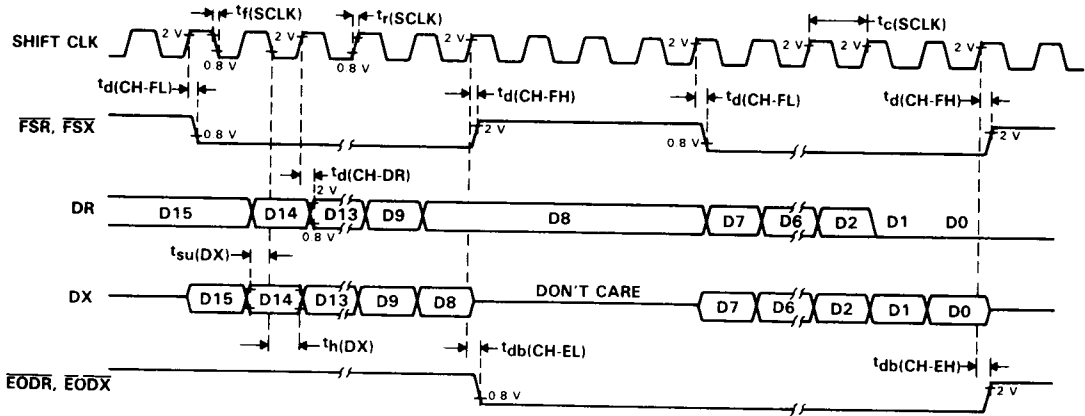

word-mode timing

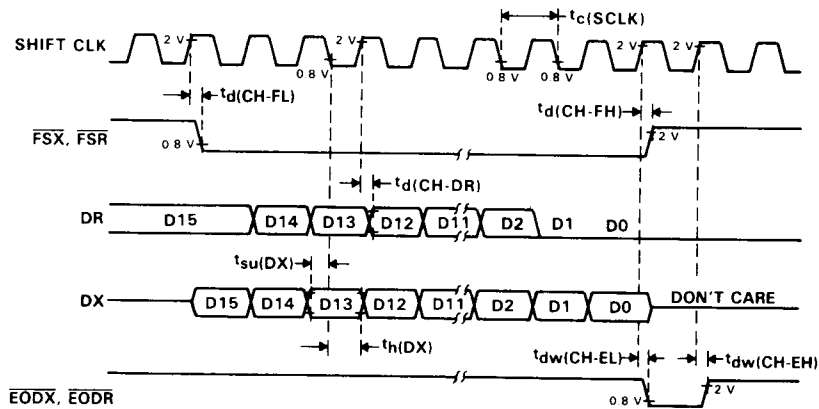

shift-clock timing

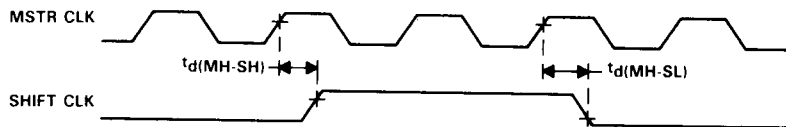

FIGURE 3. SERIAL PORT TIMING

TLC32040C, TLC32040I, TLC32041C, TLC32041I
 TLC32042C, TLC32042I
ANALOG INTERFACE CIRCUITS

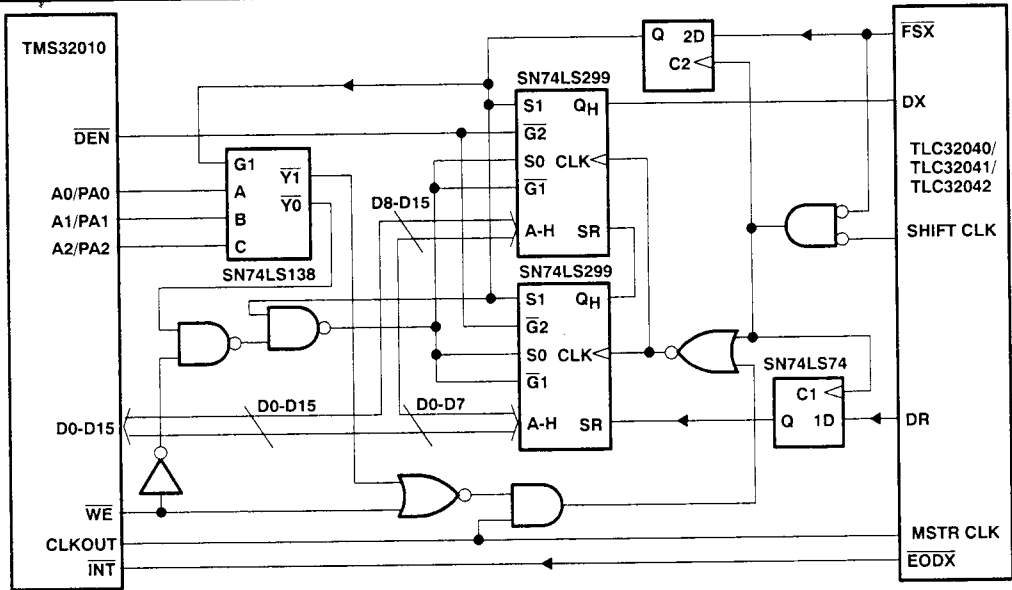
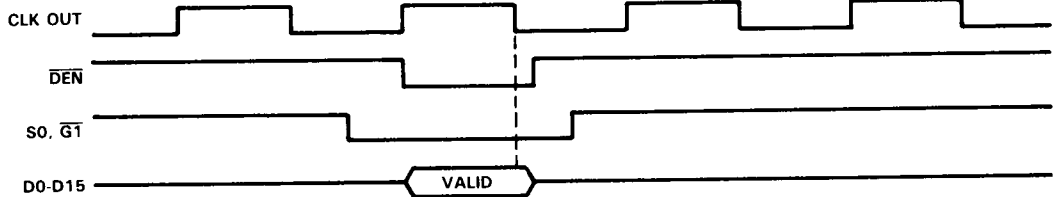

FIGURE 4. TMS32010-TLC32040/TLC32041/TLC32042 INTERFACE CIRCUIT

in instruction timing



out instruction timing

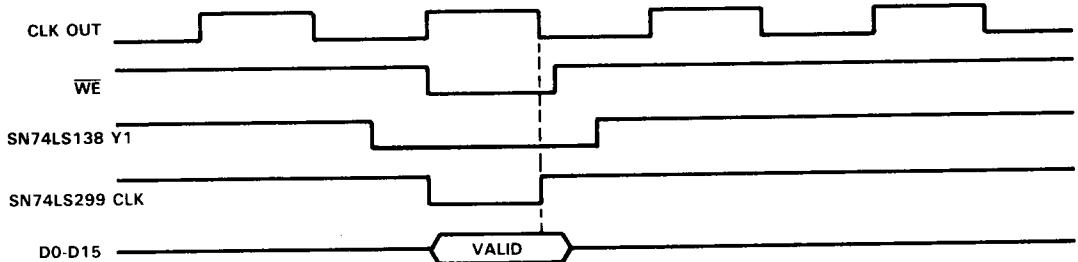
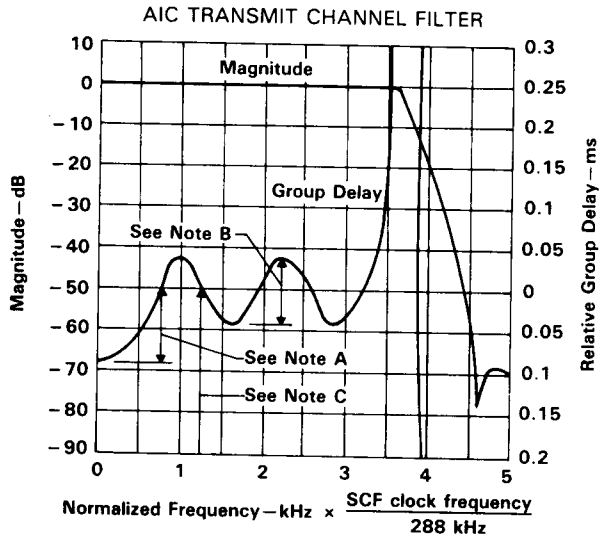

FIGURE 5. TMS32010-TLC32040/TLC32041/TLC32042 INTERFACE TIMING

TYPICAL CHARACTERISTICS



- NOTES: A. Maximum relative delay (0 Hz to 600 Hz) = 125 μ s.
 B. Maximum relative delay (600 Hz to 3000 Hz) = $\pm 50 \mu$ s.
 C. Absolute delay (600 Hz to 3000 Hz) = 700 μ s.
 D. Test conditions are V_{CC+} , V_{CC-} , and V_{DD} within recommended operating conditions, SCF clock $f = 288 \text{ kHz} \pm 2\%$, input = ± 3 -V sinewave, and $T_A = 25^\circ\text{C}$.

FIGURE 6

TYPICAL CHARACTERISTICS

TLC32040 and TLC32041
RECEIVE CHANNEL FILTER

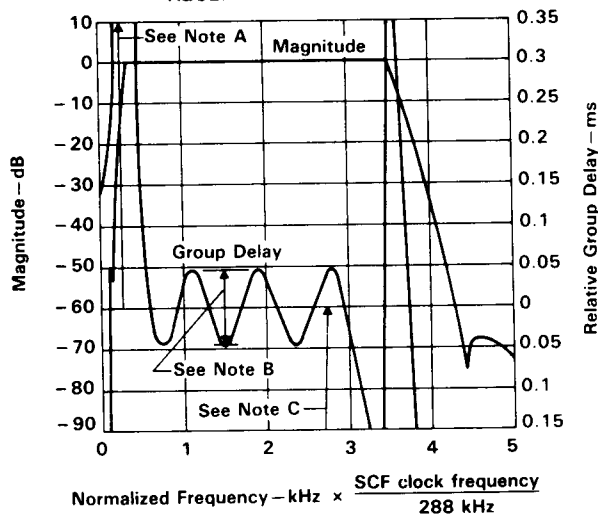

- NOTES: A. Maximum relative delay (200 Hz to 600 Hz) = 3350 μs .
B. Maximum relative delay (600 Hz to 3000 Hz) = $\pm 50 \mu\text{s}$.
C. Absolute delay (600 Hz to 3000 Hz) = 1230 μs
D. Test conditions are V_{CC+} , V_{CC-} , and V_{DD} within recommended operating conditions, SCF clock $f = 288 \text{ kHz} \pm 2\%$, input = $\pm 3\text{-V}$ sinewave, and $T_A = 25^\circ\text{C}$.

FIGURE 7

TYPICAL CHARACTERISTICS

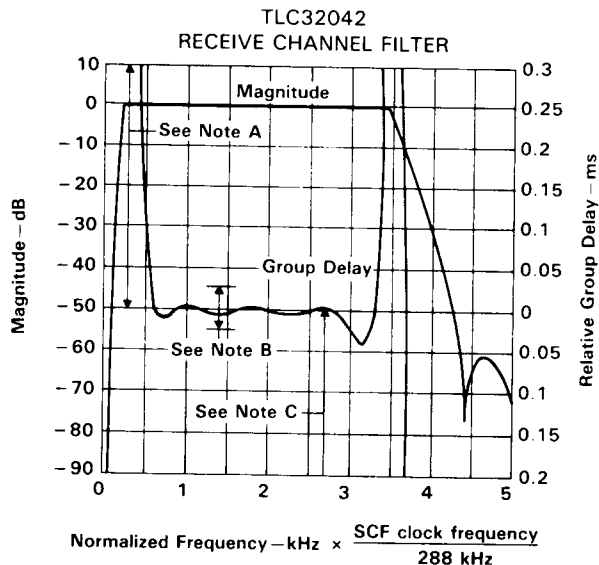

- NOTES: A. Maximum relative delay (200 Hz to 600 Hz) = 3350 μ s.
 B. Maximum relative delay (600 Hz to 3000 Hz) = $\pm 50 \mu$ s.
 C. Absolute delay (600 Hz to 3000 Hz) = 1080 μ s.
 D. Test conditions are V_{CC+} , V_{CC-} , and V_{DD} within recommended operating conditions, SCF clock $f = 288 \text{ kHz} \pm 2\%$, input = $\pm 3\text{-V}$ sinewave, and $T_A = 25^\circ\text{C}$.

FIGURE 8

TYPICAL CHARACTERISTICS

A/D SIGNAL-TO-DISTORTION RATIO
 vs
 INPUT SIGNAL

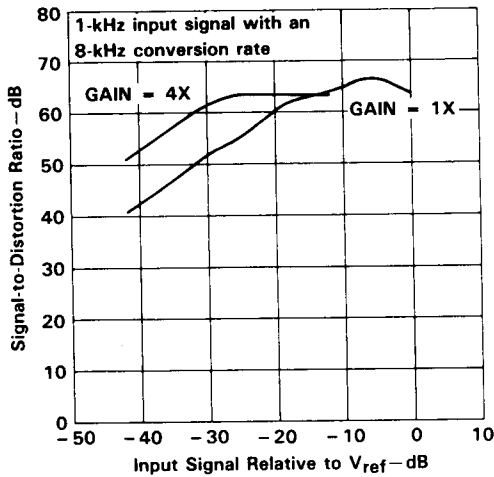

FIGURE 9

A/D GAIN TRACKING
 (GAIN RELATIVE TO GAIN
 AT 0 dB INPUT SIGNAL)

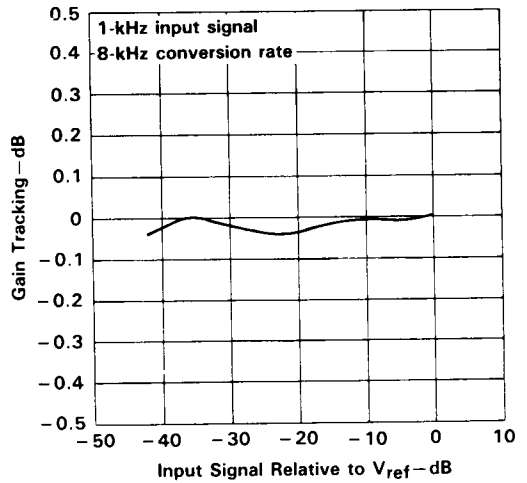

FIGURE 10

D/A CONVERTER SIGNAL-TO-DISTORTION RATIO
 vs
 INPUT SIGNAL

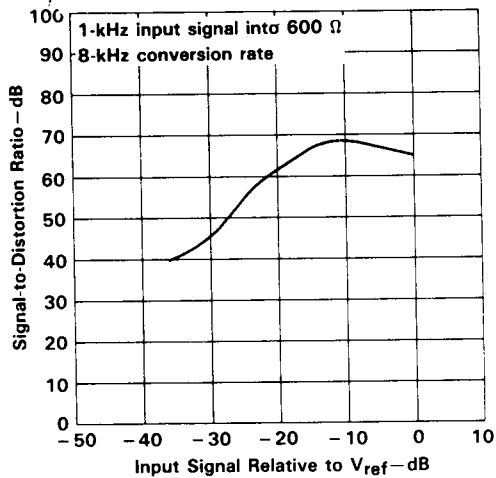

FIGURE 11

D/A GAIN TRACKING
 vs
 (GAIN RELATIVE TO GAIN
 AT 0 dB INPUT SIGNAL)

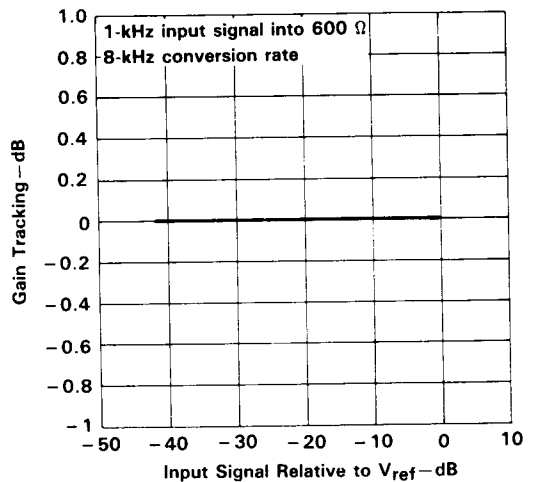

FIGURE 12

NOTE: Test conditions are V_{CC+} , V_{CC-} , and V_{DD} within recommended operating conditions set clock $f = 288 \text{ kHz} \pm 2\%$, and $T_A = 25^\circ\text{C}$.

TYPICAL CHARACTERISTICS

ATTENUATION OF SECOND HARMONIC OF A/D INPUT
vs
INPUT SIGNAL

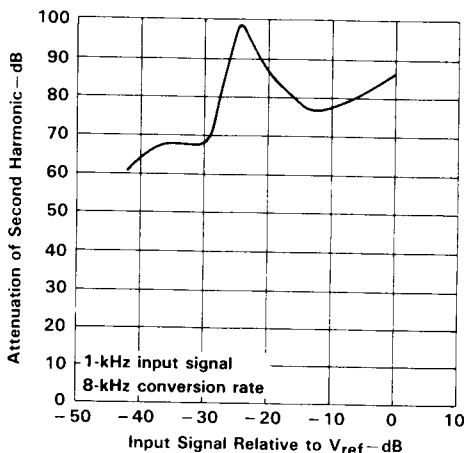

FIGURE 13

ATTENUATION OF THIRD HARMONIC OF A/D INPUT
vs
INPUT SIGNAL

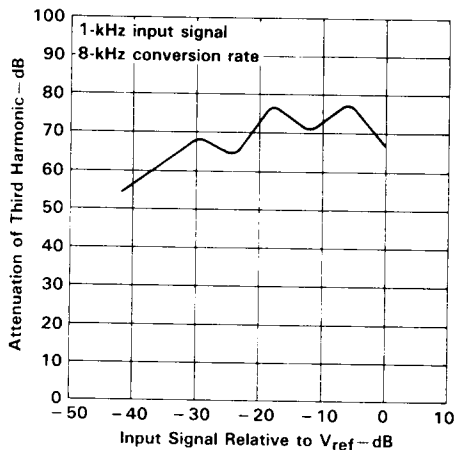

FIGURE 14

ATTENUATION OF SECOND HARMONIC OF D/A INPUT
vs
INPUT SIGNAL

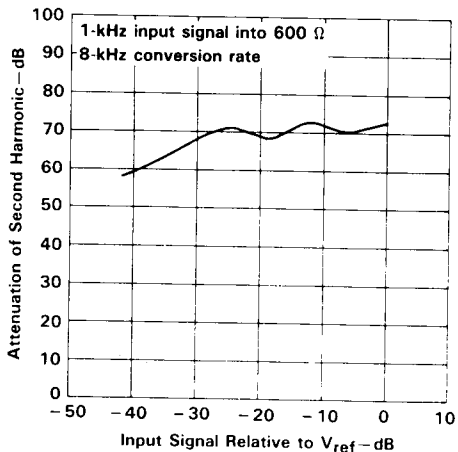

FIGURE 15

ATTENUATION OF THIRD HARMONIC OF D/A INPUT
vs
INPUT SIGNAL

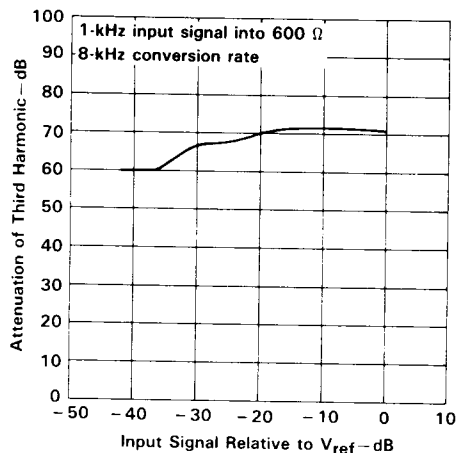
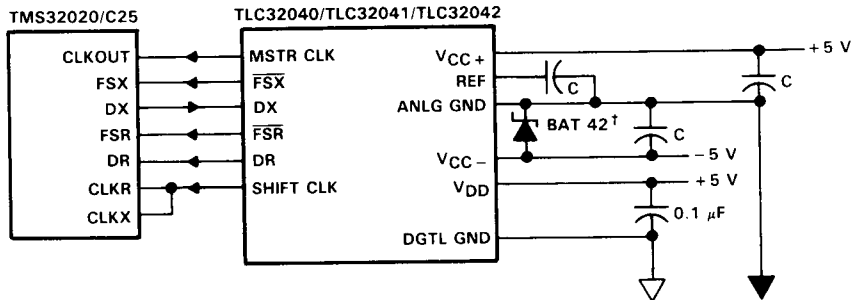

FIGURE 16

NOTE: Test conditions are V_{CC+}, V_{CC-}, and V_{DD} within recommended operating conditions set clock f = 288 kHz ± 2%, and T_A = 25 °C.

TYPICAL APPLICATION INFORMATION



C = 0.2 μ F, CERAMIC

FIGURE 17. AIC INTERFACE TO THE TMS32020/C25 SHOWING DECOUPLING CAPACITORS AND SCHOTTKY DIODE[†]

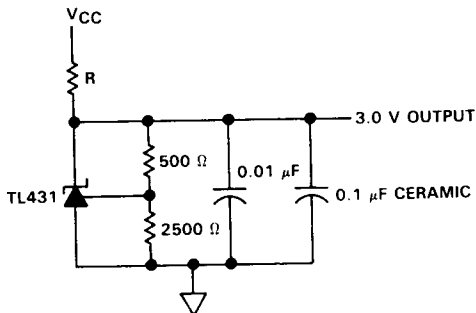

FOR: $V_{CC} = 12 \text{ V}$, $R = 7200 \Omega$
 $V_{CC} = 10 \text{ V}$, $R = 5600 \Omega$
 $V_{CC} = 5 \text{ V}$, $R = 1600 \Omega$

FIGURE 18. EXTERNAL REFERENCE CIRCUIT FOR TLC32041

[†]Thomson Semiconductors