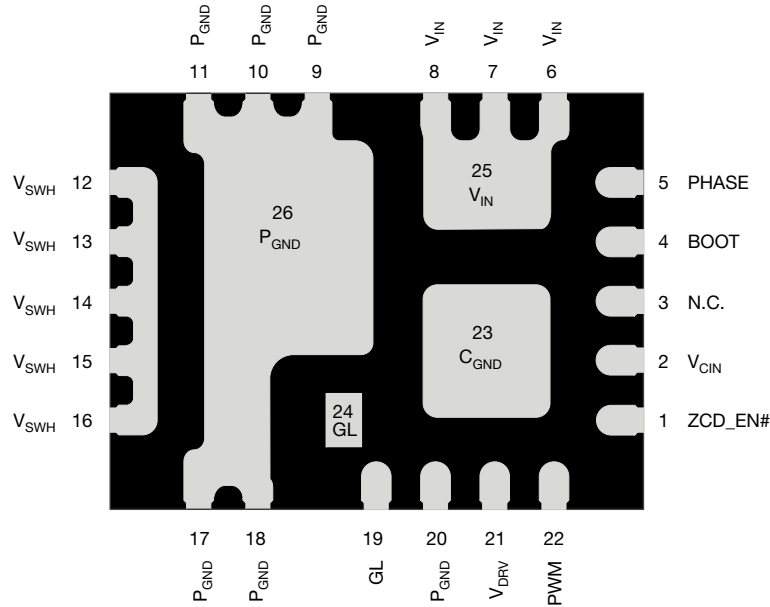
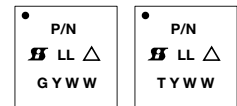
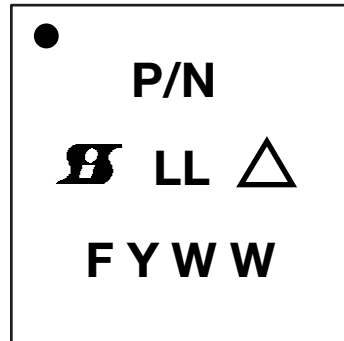




PINOUT CONFIGURATION

Fig. 2 - SiC533 Pin Configuration

PIN DESCRIPTION		
PIN NUMBER	NAME	FUNCTION
1	ZCD_EN#	The ZCD_EN# pin enables or disables Diode Emulation. When ZCD_EN# is LOW, diode emulation is allowed. When ZCD_EN# is HIGH, continuous conduction mode is forced. ZCD_EN# can also be put in a high impedance mode by floating the pin. If both ZCD_EN# and PWM are floating, the device shuts down and consumes typically 3 μ A (9 μ A max.) current
2	V _{CIN}	Supply voltage for internal logic circuitry
23	C _{GND}	Analog ground for the driver IC
3	N.C.	This pin can be either left floating or connected to C _{GND} . Internally it is either connected to GND or not internally connected depending on manufacturing location. Factory code "G" on line 3, pin 3 = C _{GND} Factory code "T" on line 3, pin 3 = not internally connected
4	BOOT	High-side driver bootstrap voltage
5	PHASE	Return path of high-side gate driver
6 to 8, 25	V _{IN}	Power stage input voltage. Drain of high-side MOSFET
9 to 11, 17, 18, 20, 26	P _{GND}	Power ground
12 to 16	V _{SWH}	Switch node of the power stage
19, 24	GL	Low-side gate signal
21	V _{DRV}	Supply voltage for internal gate driver
22	PWM	PWM control input



ORDERING INFORMATION			
PART NUMBER	PACKAGE	MARKING CODE	
SiC533CD-T1-GE3	PowerPAK® MLP4535-22L	SiC533	5 V PWM optimized
SiC533DB		Reference board	

PART MARKING INFORMATION


- = pin 1 indicator
- P/N = part number code
-  = Siliconix logo
-  = ESD symbol
- F = assembly factory code
- Y = year code
- WW = week code
- LL = lot code

ABSOLUTE MAXIMUM RATINGS			
ELECTRICAL PARAMETER	CONDITIONS	LIMIT	UNIT
Input voltage	V_{IN}	-0.3 to +28	V
Control logic supply voltage	V_{CIN}	-0.3 to +7	
Drive supply voltage	V_{DRV}	-0.3 to +7	
Switch node (DC voltage)	V_{SWH}	-0.3 to +28	
Switch node (AC voltage) ⁽¹⁾		-8 to +35	
BOOT voltage (DC voltage)	V_{BOOT}	33	
BOOT voltage (AC voltage) ⁽²⁾		40	
BOOT to PHASE (DC voltage)	$V_{BOOT-PHASE}$	-0.3 to +7	
BOOT to PHASE (AC voltage) ⁽³⁾		-0.3 to +8	
All logic inputs and outputs (PWM and ZCD_EN#)		-0.3 to $V_{CIN} + 0.3$	
Max. operating junction temperature	T_J	150	°C
Ambient temperature	T_A	-40 to +125	
Storage temperature	T_{stg}	-65 to +150	
Electrostatic discharge protection	Human body model, JESD22-A114	2000	V
	Charged device model, JESD22-C101	1000	

Note

- Stresses beyond those listed under “Absolute Maximum Ratings” may cause permanent damage to the device. These are stress ratings only, and functional operation of the device at these or any other conditions beyond those indicated in the operational sections of the specifications is not implied. Exposure to absolute maximum rating conditions for extended periods may affect device reliability
- ⁽¹⁾ The specification values indicated “AC” is V_{SWH} to P_{GND} , -8 V (< 20 ns, 10 μ J), min. and 35 V (< 50 ns), max.
- ⁽²⁾ The specification value indicates “AC voltage” is V_{BOOT} to P_{GND} , 40 V (< 50 ns) max.
- ⁽³⁾ The specification value indicates “AC voltage” is V_{BOOT} to V_{PHASE} , 8 V (< 50 ns) max.

RECOMMENDED OPERATING RANGE				
ELECTRICAL PARAMETER	MINIMUM	TYPICAL	MAXIMUM	UNIT
Input voltage (V_{IN})	4.5	-	24	V
Drive supply voltage (V_{DRV})	4.5	5	5.5	
Control logic supply voltage (V_{CIN})	4.5	5	5.5	
BOOT to PHASE ($V_{BOOT-PHASE}$, DC voltage)	4	4.5	5.5	
Thermal resistance from junction to PCB	-	5	-	°C/W
Thermal resistance from junction to case	-	2.5	-	



ELECTRICAL SPECIFICATIONS						
(ZCD_EN# = 5 V, V _{IN} = 12 V, V _{DRV} and V _{CIN} = 5 V, T _A = 25 °C, unless otherwise stated)						
PARAMETER	SYMBOL	TEST CONDITION	LIMITS			UNIT
			MIN.	TYP.	MAX.	
POWER SUPPLY						
Control logic supply current	I _{VCIN}	V _{PWM} = FLOAT	-	80	-	μA
		V _{PWM} = FLOAT, V _{ZCD_EN#} = 0 V	-	120	-	
		f _S = 300 kHz, D = 0.1	-	300	-	
Drive supply current	I _{VDRV}	f _S = 300 kHz, D = 0.1	-	7.5	12	mA
		f _S = 1 MHz, D = 0.1	-	25	-	
PS4 mode supply current	I _{VCIN} + I _{VDRV}	V _{PWM} = V _{ZCD_EN#} = FLOAT, T _A = -10 °C to +100 °C	-	3	9	μA
BOOTSTRAP SUPPLY						
Bootstrap diode forward voltage	V _F	I _F = 2 mA	-	-	0.65	V
PWM CONTROL INPUT						
Rising threshold	V _{TH_PWM_R}	V _{PWM} = FLOAT	3.6	3.9	4.2	V
Falling threshold	V _{TH_PWM_F}		0.72	1	1.3	
Tri-state voltage	V _{TRI}		-	2.5	-	
Tri-state rising threshold	V _{TRI_TH_R}		1.1	1.35	1.6	
Tri-state falling threshold	V _{TRI_TH_F}		3.4	3.7	4	
Tri-state rising threshold hysteresis	V _{HYS_TRI_R}		-	325	-	mV
Tri-state falling threshold hysteresis	V _{HYS_TRI_F}	-	250	-		
PWM input current	I _{PWM}	V _{PWM} = 5 V	-	-	350	μA
		V _{PWM} = 0 V	-	-	-350	
ZCD_EN# CONTROL INPUT						
Rising threshold	V _{TH_ZCD_EN#_R}	V _{ZCD_EN#} = FLOAT	3.3	3.6	3.9	V
Falling threshold	V _{TH_ZCD_EN#_F}		1.1	1.4	1.7	
Tri-state voltage	V _{TRI_ZCD_EN#}		-	2.5	-	
Tri-state rising threshold	V _{TRI_ZCD_EN#_R}		1.5	1.8	2.1	
Tri-state falling threshold	V _{TRI_ZCD_EN#_F}		2.9	3.15	3.4	
Tri-state rising threshold hysteresis	V _{HYS_TRI_ZCD#_R}		-	375	-	mV
Tri-state falling threshold hysteresis	V _{HYS_TRI_ZCD#_F}	-	450	-		
ZCD_EN# input current	I _{ZCD_EN#}	V _{ZCD_EN#} = 5 V	-	-	100	μA
		V _{ZCD_EN#} = 0 V	-	-	-100	
PS4 exit latency	t _{PS4EXIT}		-	-	5	μs
TIMING SPECIFICATIONS						
Tri-state to GH/GL rising propagation delay	t _{PD_TRI_R}	No load, see Fig. 4	-	20	-	ns
Tri-state hold-off time	t _{TSHO}		-	150	-	
GH - turn off propagation delay	t _{PD_OFF_GH}		-	20	-	
GH - turn on propagation delay (dead time rising)	t _{PD_ON_GH}		-	20	-	
GL - turn off propagation delay	t _{PD_OFF_GL}		-	20	-	
GL - turn on propagation delay (dead time falling)	t _{PD_ON_GL}		-	20	-	
PWM minimum on-time	T _{PWM_ON_MIN}		30	-	-	
PROTECTION						
Under voltage lockout	V _{UVLO}	V _{CIN} rising, on threshold	-	3.4	3.9	V
		V _{CIN} falling, off threshold	2.4	2.9	-	
Under voltage lockout hysteresis	V _{UVLO_HYST}		-	500	-	mV

Notes

- (1) Typical limits are established by characterization and are not production tested
- (2) Guaranteed by design



DETAILED OPERATIONAL DESCRIPTION

PWM Input with Tri-State Function

The PWM input receives the PWM control signal from the VR controller IC. The PWM input is designed to be compatible with standard controllers using two state logic (H and L) and advanced controllers that incorporate tri-state logic (H, L and tri-state) on the PWM output. For two state logic, the PWM input operates as follows. When PWM is driven above $V_{PWM_TH_R}$ the low-side is turned off and the high-side is turned on. When PWM input is driven below $V_{PWM_TH_F}$ the high-side is turned off and the low-side is turned on. For tri-state logic, the PWM input operates as previously stated for driving the MOSFETs when PWM is logic high and logic low. However, there is a third state that is entered as the PWM output of tri-state compatible controller enters its high impedance state during shut-down. The high impedance state of the controller's PWM output allows the SiC533 to pull the PWM input into the tri-state region (see definition of PWM logic and tri-state, Fig. 4). If the PWM input stays in this region for the tri-state hold-off period, t_{TSHO} , both high-side and low-side MOSFETs are turned off. The function allows the VR phase to be disabled without negative output voltage swing caused by inductor ringing and saves a Schottky diode clamp. The PWM and tri-state regions are separated by hysteresis to prevent false triggering. The SiC533 incorporates PWM voltage thresholds that are compatible with 5 V logic.

Diode Emulation Mode and PS4 Mode (ZCD_EN#)

The ZCD_EN# pin enables or disables diode emulation mode. When ZCD_EN# is driven below $V_{TH_ZCD_EN\#_F}$, diode emulation is allowed. When ZCD_EN# is driven above $V_{TH_ZCD_EN\#_R}$, continuous conduction mode is forced. Diode emulation mode allows for higher converter efficiency under light load situations. With diode emulation active, the SiC533 will detect the zero current crossing of the output inductor and turn off the low-side MOSFET. This ensures that discontinuous conduction mode (DCM) is achieved. Diode emulation is asynchronous to the PWM signal, therefore, the SiC533 will respond to the ZCD_EN# input immediately after it changes state.

The ZCD_EN# pin can be floated resulting in a high impedance state. High impedance on the input of ZCD_EN# combined with a tri-stated PWM output will shut down the SiC533, reducing current consumption to typically 5 μ A. This is an important feature in achieving the low standby current requirements required in the PS4 state in ultrabooks and notebooks.

Voltage Input (V_{IN})

This is the power input to the drain of the high-side power MOSFET. This pin is connected to the high power intermediate BUS rail.

Switch Node (V_{SWH} and PHASE)

The switch node, V_{SWH}, is the circuit power stage output. This is the output applied to the power inductor and output filter to deliver the output for the buck converter. The PHASE pin is internally connected to the switch node, V_{SWH}. This pin is to be used exclusively as the return pin for the BOOT capacitor.

Ground Connections (C_{GND} and P_{GND})

P_{GND} (power ground) should be externally connected to C_{GND} (control signal ground). The layout of the printed circuit board should be such that the inductance separating C_{GND} and P_{GND} is minimized. Transient differences due to inductance effects between these two pins should not exceed 0.5 V.

Control and Drive Supply Voltage Input (V_{DRV}, V_{CIN})

V_{CIN} is the bias supply for the gate drive control IC. V_{DRV} is the bias supply for the gate drivers. It is recommended to separate these pins through a resistor. This creates a low pass filtering effect to avoid coupling of high frequency gate drive noise into the IC.

Bootstrap Circuit (BOOT)

The internal bootstrap diode and an external bootstrap capacitor form a charge pump that supplies voltage to the BOOT pin. An integrated bootstrap diode is incorporated so that only an external capacitor is necessary to complete the bootstrap circuit. Connect a boot strap capacitor with one leg tied to BOOT pin and the other tied to PHASE pin.

Shoot-Through Protection and Adaptive Dead Time

The SiC533 has an internal adaptive logic to avoid shoot through and optimize dead time. The shoot through protection ensures that both high-side and low-side MOSFETs are not turned on at the same time. The adaptive dead time control operates as follows. The high-side and low-side gate voltages are monitored to prevent the MOSFET turning on from tuning on until the other MOSFET's gate voltage is sufficiently low (< 1 V). Built in delays also ensure that one power MOSFET is completely off, before the other can be turned on. This feature helps to adjust dead time as gate transitions change with respect to output current and temperature.

Under Voltage Lockout (UVLO)

During the start up cycle, the UVLO disables the gate drive, holding high-side and low-side MOSFET gates low, until the supply voltage rail has reached a point at which the logic circuitry can be safely activated. The SiC533 also incorporates logic to clamp the gate drive signals to zero when the UVLO falling edge triggers the shutdown of the device.

PWM TIMING DIAGRAM

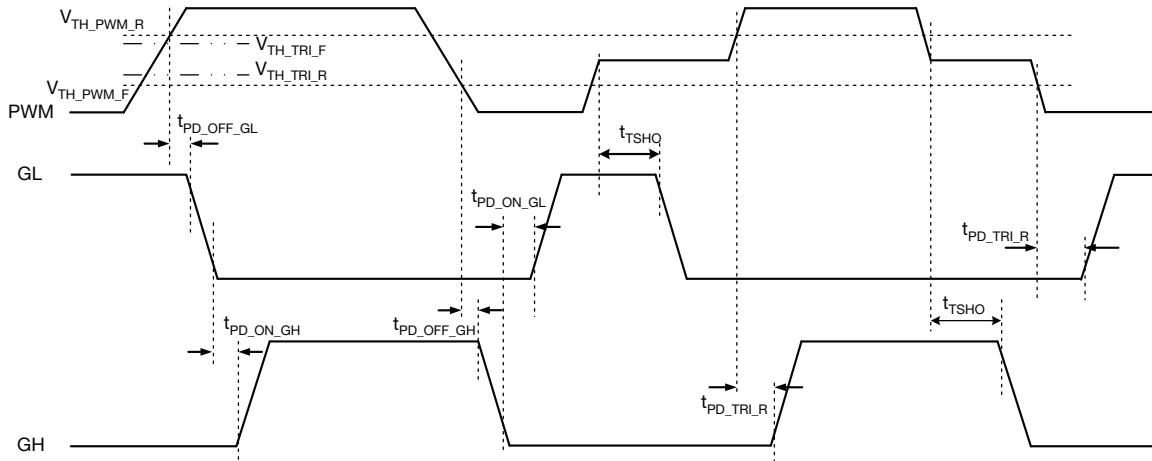


Fig. 4 - Definition of PWM Logic and Tri-State

ZCD_EN# - PS4 EXIT TIMING

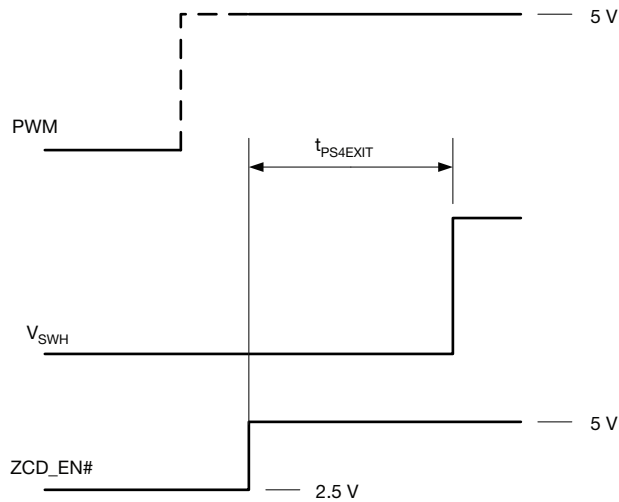


Fig. 5 - ZCD_EN# - PS4 Exit Timing

ELECTRICAL CHARACTERISTICS

Test condition: $V_{IN} = 12\text{ V}$, $V_{DRV} = V_{CIN} = 5\text{ V}$, $ZCD_EN\# = 5\text{ V}$, $V_{OUT} = 1\text{ V}$, $L_{OUT} = 250\text{ nH}$, (DCR = 0.32 mΩ), $T_A = 25\text{ °C}$
 (All power loss and normalized power loss curves show SiC533 losses only unless otherwise stated)

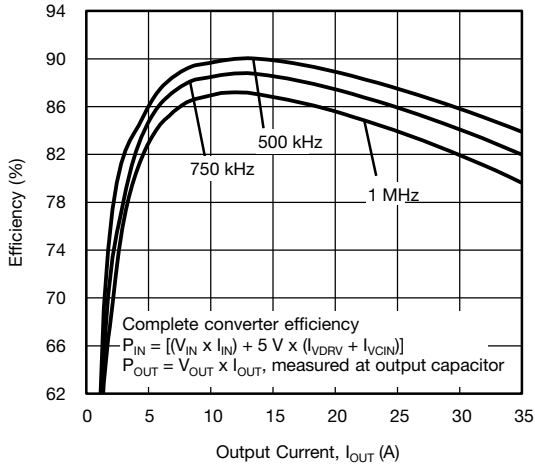


Fig. 6 - Efficiency vs. Output Current ($V_{IN} = 12\text{ V}$)

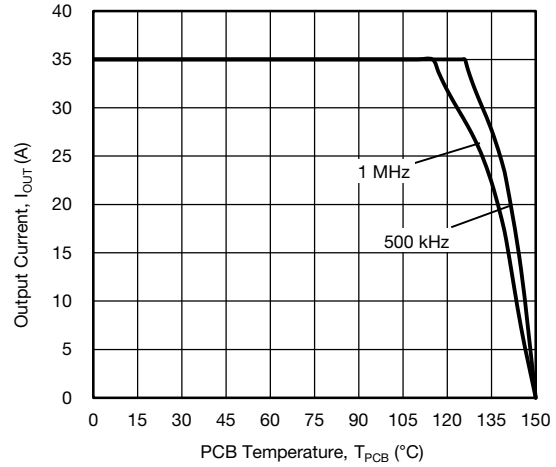


Fig. 9 - Safe Operating Area ($V_{IN} = 12\text{ V}$)

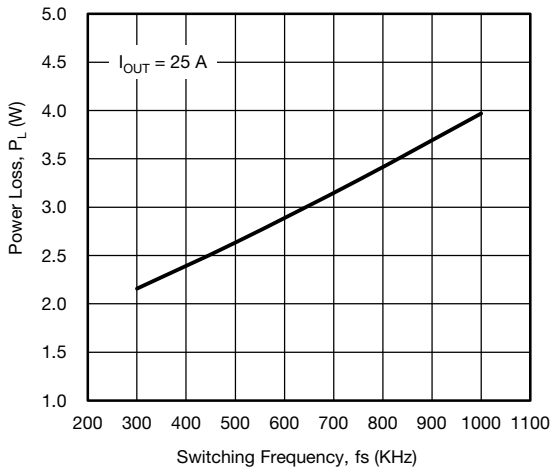


Fig. 7 - Power Loss vs. Switching Frequency ($V_{IN} = 12\text{ V}$)

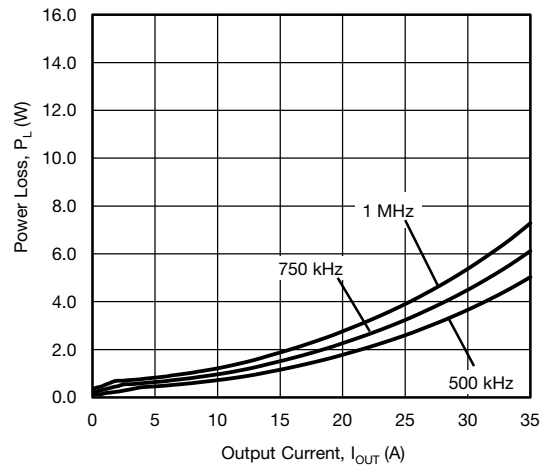


Fig. 10 - Power Loss vs. Output Current ($V_{IN} = 12\text{ V}$)

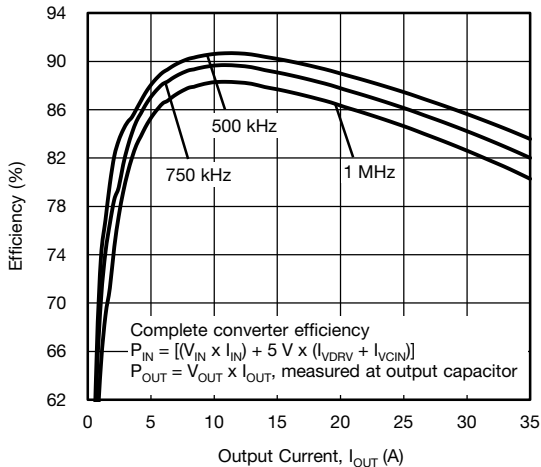


Fig. 8 - Efficiency vs. Output Current ($V_{IN} = 9\text{ V}$)

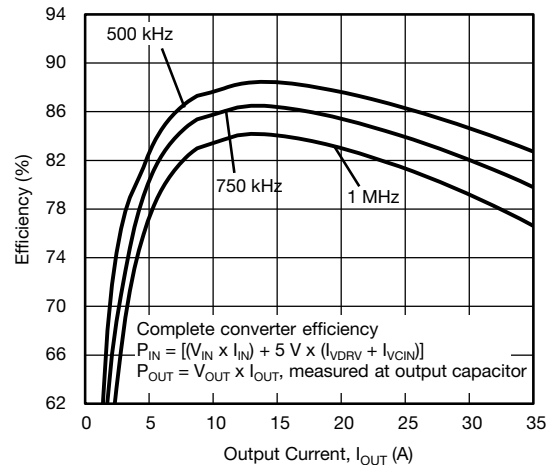
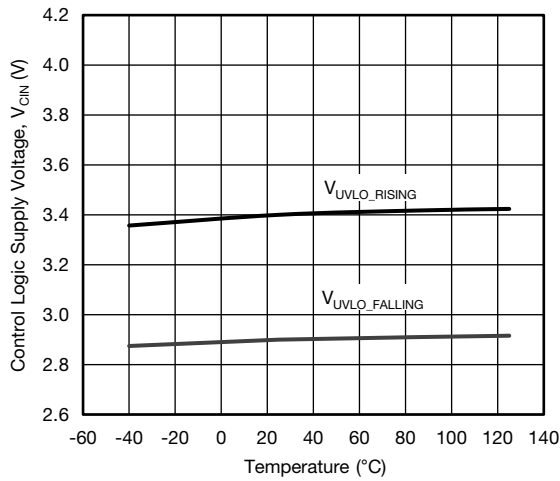
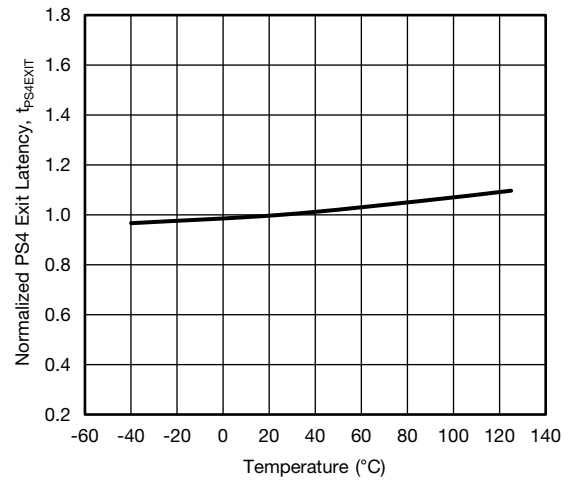
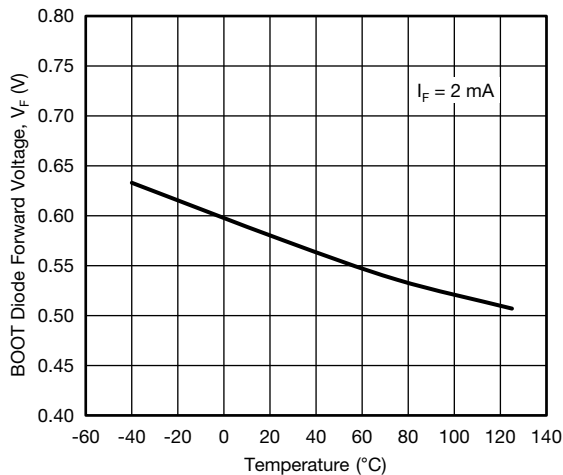
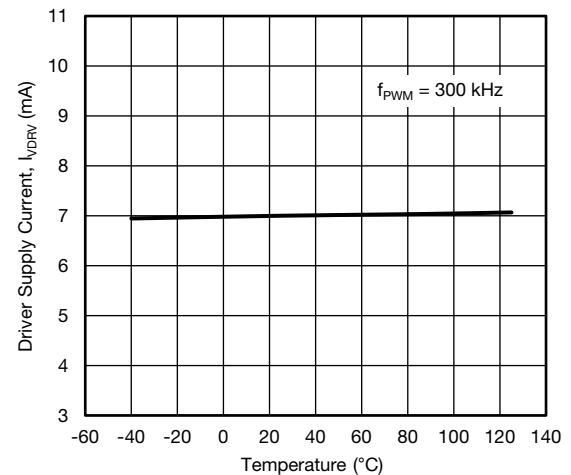
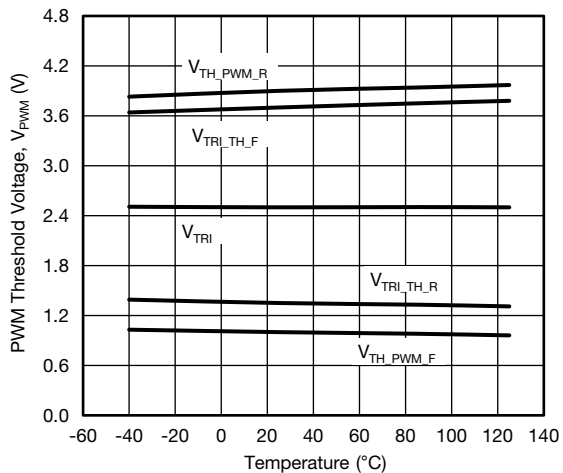
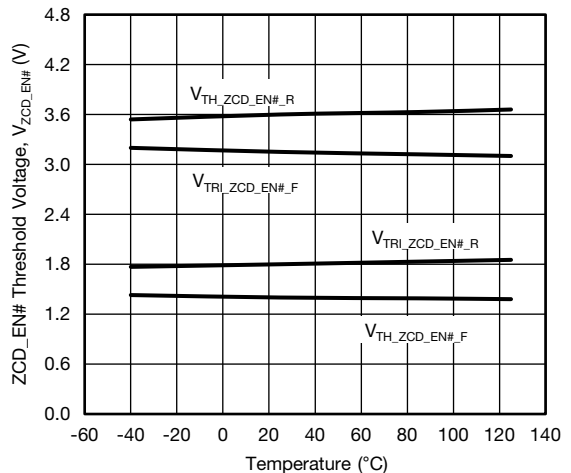
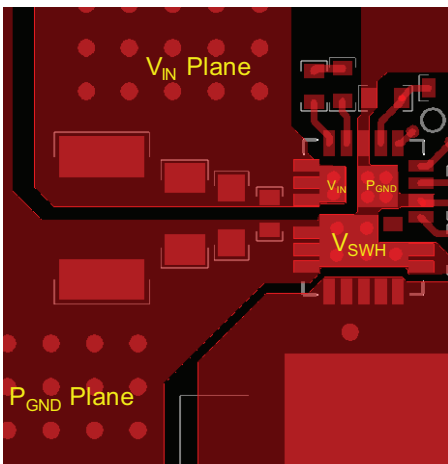


Fig. 11 - Efficiency vs. Output Current ($V_{IN} = 19\text{ V}$)

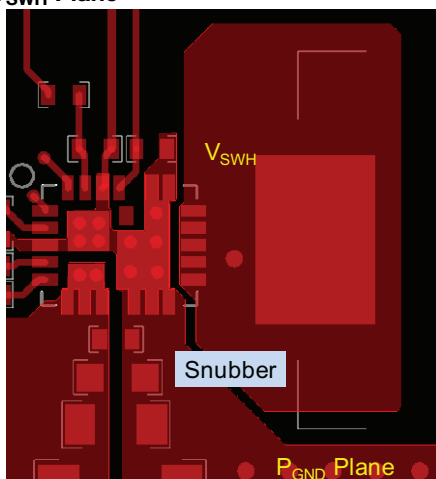
ELECTRICAL CHARACTERISTICS

Test condition: $V_{IN} = 12\text{ V}$, $V_{DRV} = V_{CIN} = 5\text{ V}$, $ZCD_EN\# = 5\text{ V}$, $V_{OUT} = 1\text{ V}$, $L_{OUT} = 250\text{ nH}$, (DCR = 0.32 m Ω), $T_A = 25\text{ }^\circ\text{C}$
 (All power loss and normalized power loss curves show SiC533 losses only unless otherwise stated)

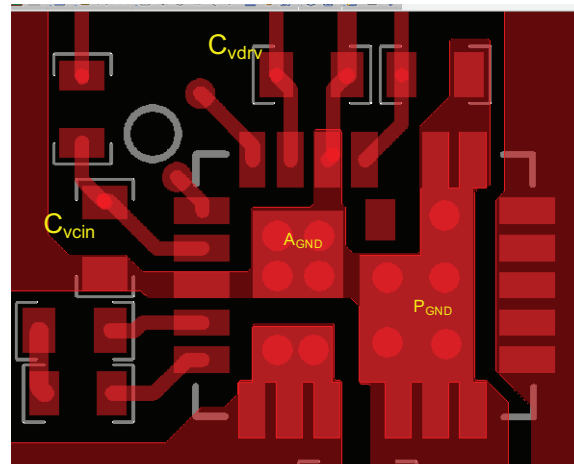

Fig. 12 - UVLO Threshold vs. Temperature

Fig. 15 - PS4 Exit Latency vs. Temperature

Fig. 13 - BOOT Diode Forward Voltage vs. Temperature

Fig. 16 - Driver Supply Current vs. Temperature

Fig. 14 - PWM Threshold vs. Temperature

Fig. 17 - ZCD_EN# Threshold vs. Temperature

PCB LAYOUT RECOMMENDATIONS
Step 1: V_{IN} / P_{GND} Planes and Decoupling


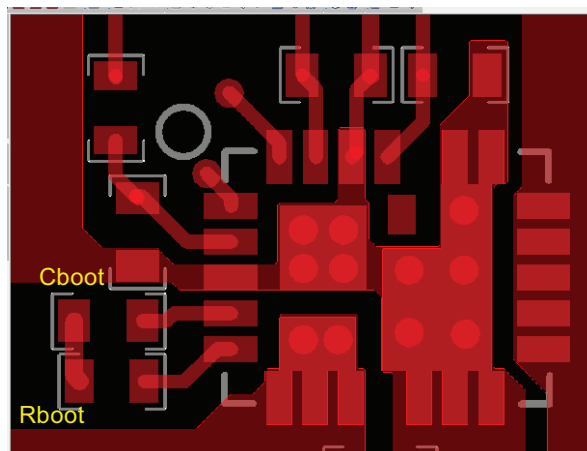
1. Layout V_{IN} and P_{GND} planes as shown above.
2. Ceramic capacitors should be placed directly between V_{IN} and P_{GND} , and close to the device for best decoupling effect.
3. Different values / packages of ceramic capacitors should be used to cover entire decoupling spectrum e.g. 1210, 0805, 0603, 0402.
4. Smaller capacitance values, placed closer to the device's V_{IN} pin(s), results in better high frequency noise absorbing.

Step 2: V_{SWH} Plane


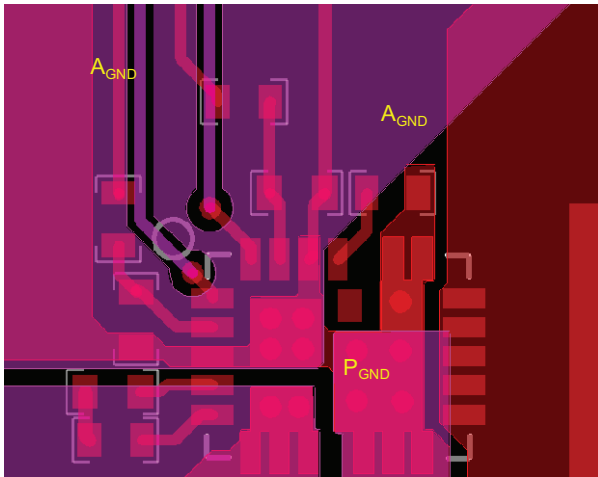
1. Connect output inductor to IC with large plane to lower resistance.
2. V_{SWH} plane also serves as a heat-sink for low-side MOSFET. Make the plane wide and short to achieve the best thermal path.
3. If a snubber network is required, place the components as shown above, the network can be placed at bottom.

Step 3: V_{CIN} / V_{DRV} Input Filter


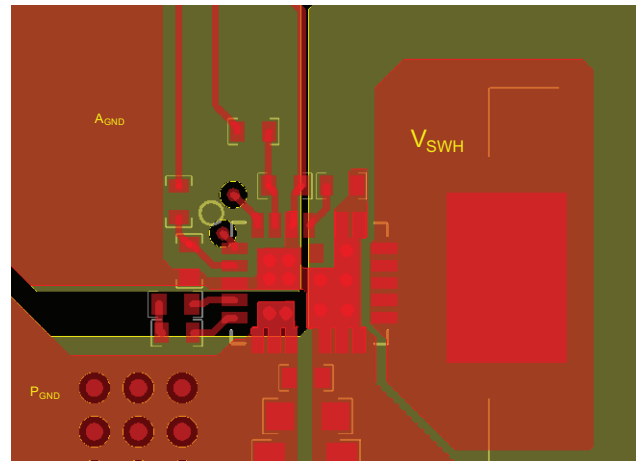
1. The V_{CIN} / V_{DRV} input filter ceramic cap should be placed as close as possible to the IC. It is recommended to connect two capacitors separately.
2. V_{CIN} capacitor should be placed between pin 2 (V_{CIN}) and pin 3 (A_{GND} of driver IC) to achieve best noise filtering.
3. V_{DRV} capacitor should be placed between pin 20 (P_{GND} of driver IC) and pin 21 (V_{DRV}) to provide maximum instantaneous driver current for low side MOSFET during switching cycle.
4. For connecting V_{CIN} to A_{GND} , it is recommended to use a large plane to reduce parasitic inductance.

Step 4: BOOT Resistor and Capacitor Placement


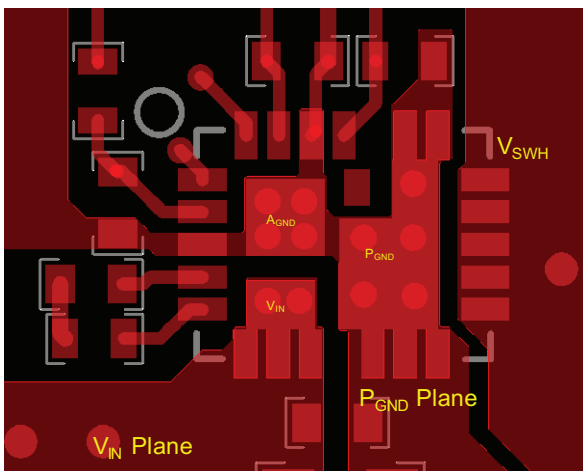
1. The components need to be placed as close as possible to IC, directly between PHASE (pin 5) and BOOT (pin 4).
2. To reduce parasitic inductance, chip size 0402 can be used.

Step 5: Signal Routing


1. Route the PWM and ZCD_EN# signal traces out of the top left corner next to pin 1.
2. The PWM signal is an important signal, both signal and return traces should not cross any power nodes on any layer.
3. It is best to “shield” these traces from power switching nodes, e.g. V_{SWH} , with a GND island to improve signal integrity.
4. GL (pin 19) has been connected with GL pad (pin 24) internally.

Step 7: Ground Connection


1. It is recommended to make a single connection between A_{GND} and P_{GND} which can be made on the top layer.
2. It is recommended to make the entire first inner layer (below top layer) the ground plane and separate them into A_{GND} and P_{GND} planes.
3. These ground planes provide shielding between noise sources on top layer and signal traces on bottom layer.

Step 6: Adding Thermal Relief Vias


1. Thermal relief vias can be added on the V_{IN} and A_{GND} pads to utilize inner layers for high-current and thermal dissipation.
2. To achieve better thermal performance, additional vias can be placed on V_{IN} plane and P_{GND} plane.
3. V_{SWH} pad is a noise source, it is not recommended to place vias on this pad.
4. 8 mil vias for pads and 10 mils vias for planes are the optimal via sizes. Vias on pad may drain solder during assembly and cause assembly issues. Consult with the assembly house for guidelines.

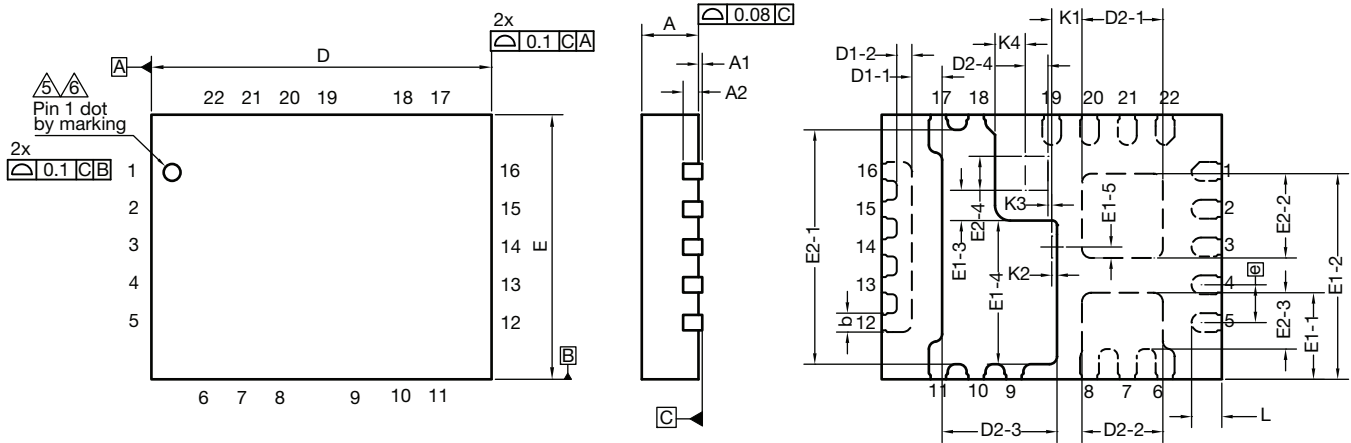


PRODUCT SUMMARY	
Part number	SiC533
Description	35 A power stage, 4.5 V _{IN} to 24 V _{IN} , 5 V PWM with ZCD, PS4 mode
Input voltage min. (V)	4.5
Input voltage max. (V)	24
Continuous current rating max. (A)	35
Switch frequency max. (kHz)	2000
Enable (yes / no)	No
Monitoring features	-
Protection	UVLO, THDN
Light load mode	ZCD, PS4
Pulse-width modulation (V)	5
Package type	PowerPAK MLP4535-22L
Package size (W, L, H) (mm)	4.5 x 3.5 x 0.75
Status code	2
Product type	VRPower (DrMOS)
Applications	Computer, industrial, networking

Vishay Siliconix maintains worldwide manufacturing capability. Products may be manufactured at one of several qualified locations. Reliability data for Silicon Technology and Package Reliability represent a composite of all qualified locations. For related documents such as package / tape drawings, part marking, and reliability data, see www.vishay.com/ppg?75010.



MLP 4.5 x 3.5-22L BWL Case Outline



DIM.	MILLIMETERS			INCHES		
	MIN.	NOM.	MAX.	MIN.	NOM.	MAX.
A ⁽⁸⁾	0.70	0.75	0.80	0.027	0.0029	0.031
A1	0.00	-	0.05	0.000	-	0.002
A2	0.20 ref.			0.008 ref.		
b ⁽⁴⁾	0.20	0.25	0.30	0.0078	0.0098	0.0110
D	4.50 BSC			0.177 BSC		
e	0.50 BSC			0.019 BSC		
E	3.50 BSC			0.137 BSC		
L	0.35	0.40	0.45	0.013	0.015	0.017
N ⁽³⁾	22			22		
Nd ⁽³⁾	6			6		
Ne ⁽³⁾	5			5		
D1-1	0.35	0.40	0.45	0.013	0.015	0.017
D1-2	0.15	0.20	0.25	0.005	0.007	0.009
D2-1	1.02	1.07	1.12	0.040	0.042	0.044
D2-2	1.02	1.07	1.12	0.040	0.042	0.044
D2-3	1.47	1.52	1.57	0.057	0.059	0.061
D2-4	0.25	0.30	0.35	0.009	0.011	0.013
E1-1	1.095	1.145	1.195	0.043	0.045	0.047
E1-2	2.67	2.72	2.77	0.105	0.107	0.109
E1-3	0.35	0.40	0.45	0.013	0.015	0.017
E1-4	1.85	1.90	1.95	0.072	0.074	0.076
E1-5	0.095	0.145	0.195	0.0037	0.0057	0.0076
E2-1	3.05	3.10	3.15	0.120	0.122	0.124
E2-2	1.065	1.115	1.165	0.0419	0.0438	0.0458
E2-3	0.695	0.745	0.795	0.027	0.029	0.031
E2-4	0.40	0.45	0.50	0.015	0.017	0.019
K1	0.40 BSC			0.015 BSC		
K2	0.07 BSC			0.002 BSC		
K3	0.05 BSC			0.001 BSC		
K4	0.40 BSC			0.015 BSC		



Notes

1. Use millimeters as the primary measurement
2. Dimensioning and tolerances conform to ASME Y14.5M. - 1994
3. N is the number of terminals,
Nd is the number of terminals in X-direction and
Ne is the number of terminals in Y-direction.
4. Dimension b applies to plated terminal and is measured between 0.20 mm and 0.25 mm from terminal tip
5. The pin #1 identifier must be existed on the top surface of the package by using indentation mark or other feature of package body
6. Exact shape and size of this feature is optional
7. Package warpage max. 0.08 mm
8. Applied only for terminals

T14-0626-Rev. A, 20-Oct-14
DWG: 6028



Disclaimer

ALL PRODUCT, PRODUCT SPECIFICATIONS AND DATA ARE SUBJECT TO CHANGE WITHOUT NOTICE TO IMPROVE RELIABILITY, FUNCTION OR DESIGN OR OTHERWISE.

Vishay Intertechnology, Inc., its affiliates, agents, and employees, and all persons acting on its or their behalf (collectively, "Vishay"), disclaim any and all liability for any errors, inaccuracies or incompleteness contained in any datasheet or in any other disclosure relating to any product.

Vishay makes no warranty, representation or guarantee regarding the suitability of the products for any particular purpose or the continuing production of any product. To the maximum extent permitted by applicable law, Vishay disclaims (i) any and all liability arising out of the application or use of any product, (ii) any and all liability, including without limitation special, consequential or incidental damages, and (iii) any and all implied warranties, including warranties of fitness for particular purpose, non-infringement and merchantability.

Statements regarding the suitability of products for certain types of applications are based on Vishay's knowledge of typical requirements that are often placed on Vishay products in generic applications. Such statements are not binding statements about the suitability of products for a particular application. It is the customer's responsibility to validate that a particular product with the properties described in the product specification is suitable for use in a particular application. Parameters provided in datasheets and / or specifications may vary in different applications and performance may vary over time. All operating parameters, including typical parameters, must be validated for each customer application by the customer's technical experts. Product specifications do not expand or otherwise modify Vishay's terms and conditions of purchase, including but not limited to the warranty expressed therein.

Hyperlinks included in this datasheet may direct users to third-party websites. These links are provided as a convenience and for informational purposes only. Inclusion of these hyperlinks does not constitute an endorsement or an approval by Vishay of any of the products, services or opinions of the corporation, organization or individual associated with the third-party website. Vishay disclaims any and all liability and bears no responsibility for the accuracy, legality or content of the third-party website or for that of subsequent links.

Except as expressly indicated in writing, Vishay products are not designed for use in medical, life-saving, or life-sustaining applications or for any other application in which the failure of the Vishay product could result in personal injury or death. Customers using or selling Vishay products not expressly indicated for use in such applications do so at their own risk. Please contact authorized Vishay personnel to obtain written terms and conditions regarding products designed for such applications.

No license, express or implied, by estoppel or otherwise, to any intellectual property rights is granted by this document or by any conduct of Vishay. Product names and markings noted herein may be trademarks of their respective owners.