



General Purpose Gigabit Transmission  
Metric System Connector

CONNECTOR

MB-0206-1

August 2010

## MJ06 Series

**RoHS Compliant**

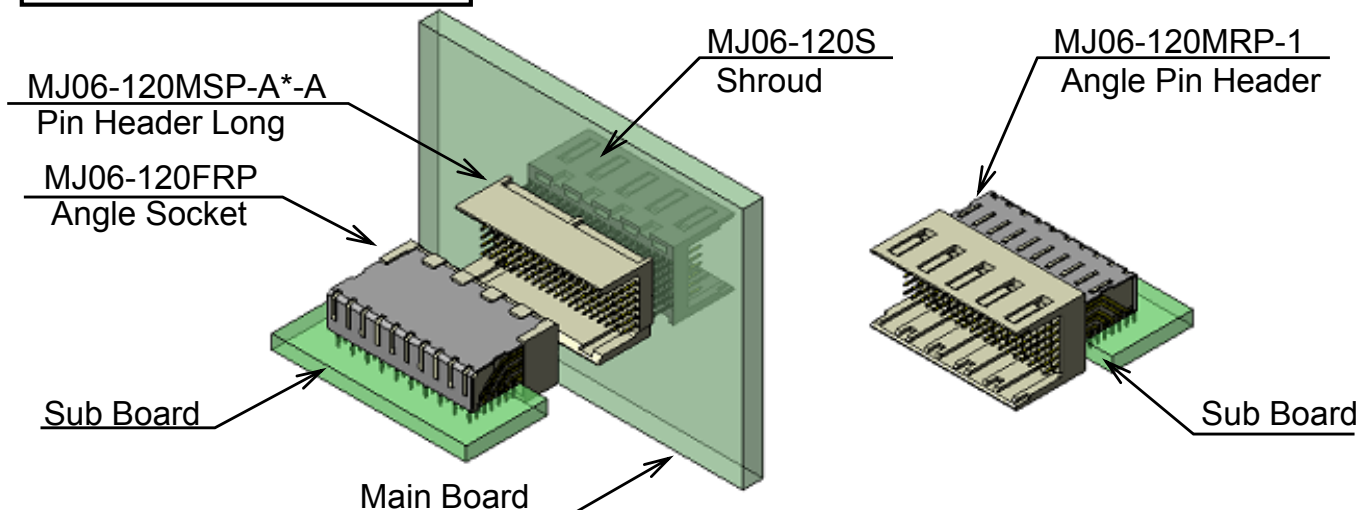

The MJ06 Series is a high-speed signal connector for differential transmission, compatible with backplane/midplane type devices. It has superior high-speed transmission performance, with a balanced transmission structure that is ideal for differential transmission and allows for a simplified mounting pattern design.

### Features

- Compatible with IEC61076-4-101 mounting dimensions. Usage is possible with the same standard connectors (known as HM connectors).
- Pair signal alignment (side pair, 1.8mm pitch) and ground structure, optimized for high-speed differential transmission
- Symmetrical pin structure prevents skew between differential signal pair.
- Press-fit attachment to board for both pin side and socket side connector (finished diameter compatible with 0.6mm dia.)
- Through-hole location to optimize board wiring pattern.
- Compatible with connector height 9mm max. from board, minimum slot distance 17mm.
- Available in cable connection type. (Please contact us for more information.)

### Applications

- Factory automation equipment, semiconductor manufacturing equipment, various inspection and measuring devices, server/storage devices, communication/network devices, broadcasting equipment, medical equipment, etc.

### General Specifications

- No. of Contacts: 120 pos. (signal + ground / module)
- Differential Impedance:  $100\Omega \pm 15\Omega$  ( $T_r=100ps$  [10-90%])
- Crosstalk: 5% max. ( $T_r=100ps$  [10-90%])
- Rated Voltage: AC200 Vr.m.s
- Rated Current: 1A
- Operating Temperature: -35 to 85 Deg. C
- Compliant Pin: single insertion force 100N max. / single retention force 10N min. (after test)
- Applicable Board Thickness: 1.4mm to 5.0mm

# MJ06 Series Mating Operation

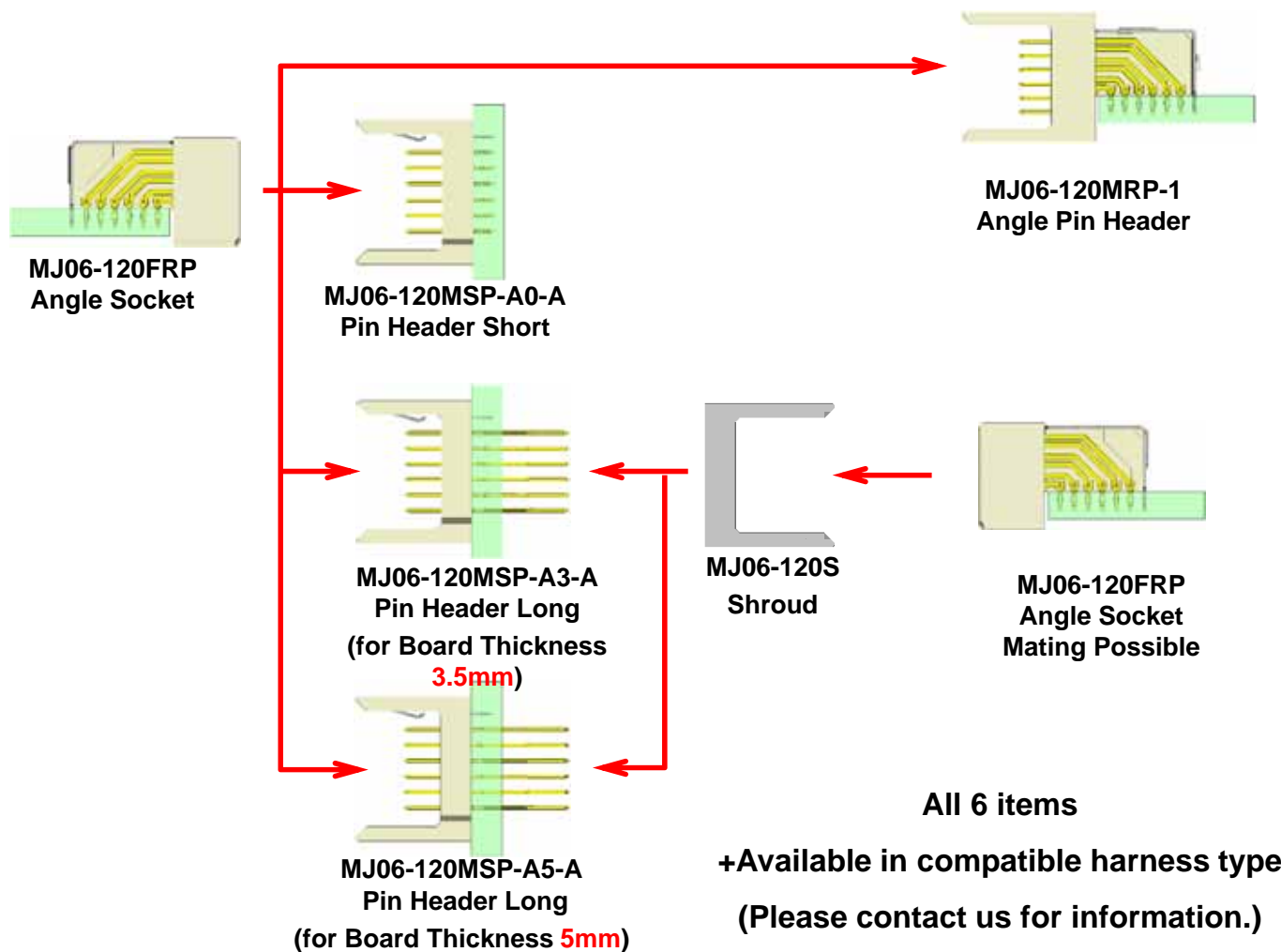

## Materials and Finishes

Pin Connector	
Component	Material / Finish
Insulator	Glass filled PBT (white)
Contact	Copper alloy / Contact area: Au plating over Ni Terminal area: Au flash plating over Ni (Note) Pin contact and ground contact in common

Socket Connector	
Component	Material / Finish
Insulator	Glass filled PBT (white)
Contact	Copper alloy / Contact area: Au plating over Ni Terminal area: Au flash plating over Ni (Note) Socket contact and ground plate in common

### Board Through-Hole Specification (for reference)

Board Material	Glass fabric filled laminated epoxy board
Board Thickness	1.4mm to 5.0mm
Finished Diameter (Au flash plating over copper)	0.6mm dia. ± 0.05mm
Copper Plating Thickness	20 μm (min.)
Prepared Hole Drilled Diameter	0.7mm dia. ± 0.025mm

Ordering Information

Angle Socket

MJ06-120 F R P

Series

Connection Method: P = Pressfit

Connection Direction: R = Right Angle, S = Straight

Product Configuration: F = Socket Contact,  
M = Pin Contact, S = Shroud

No. of Contacts: 120 pos.

Straight Pin Header

MJ06-120 M S P-A 0-A

Product Identification Mark

Applicable Board Thickness: 0 = 1.4mm min.  
(shroud attachment) 3 = t3.5 ± 0.3 (mm)  
(shroud attachment) 5 = t5.0 ± 0.4 (mm)

Insulator Shape: A = for Angle socket

Connection Method: P = Press-fit

Connection Direction: R = Right Angle, S = Straight

Product Configuration: F = Socket Contact,  
M = Pin Contact, S = Shroud

No. of Contacts: 120 pos.

Angle Pin Header

MJ06-120 M R P-1

Mating Lock: 1 = One-action type

Connection Method: P = Pressfit

Connection Direction: R = Right Angle, S = Straight

Product Configuration: F = Socket Contact,  
M = Pin Contact, S = Shroud

No. of Contacts: 120 pos.

Shroud

MJ06-120 S

Product Configuration: F = Socket Contact,  
M = Pin Contact, S = Shroud

No. of Contacts: 120 pos.

# MJ06-120FRP (Angle Socket)

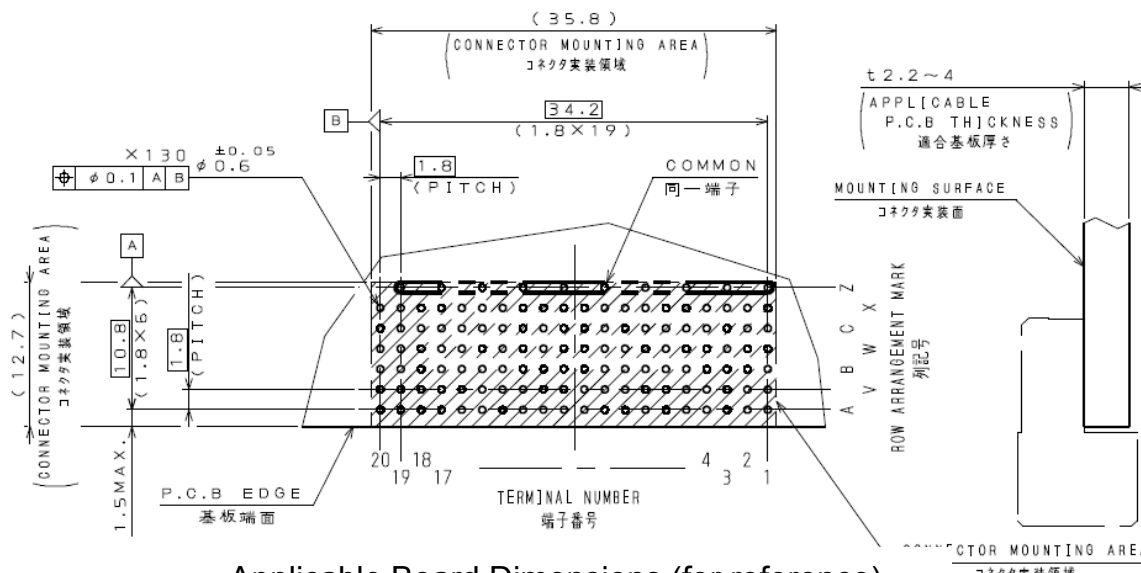
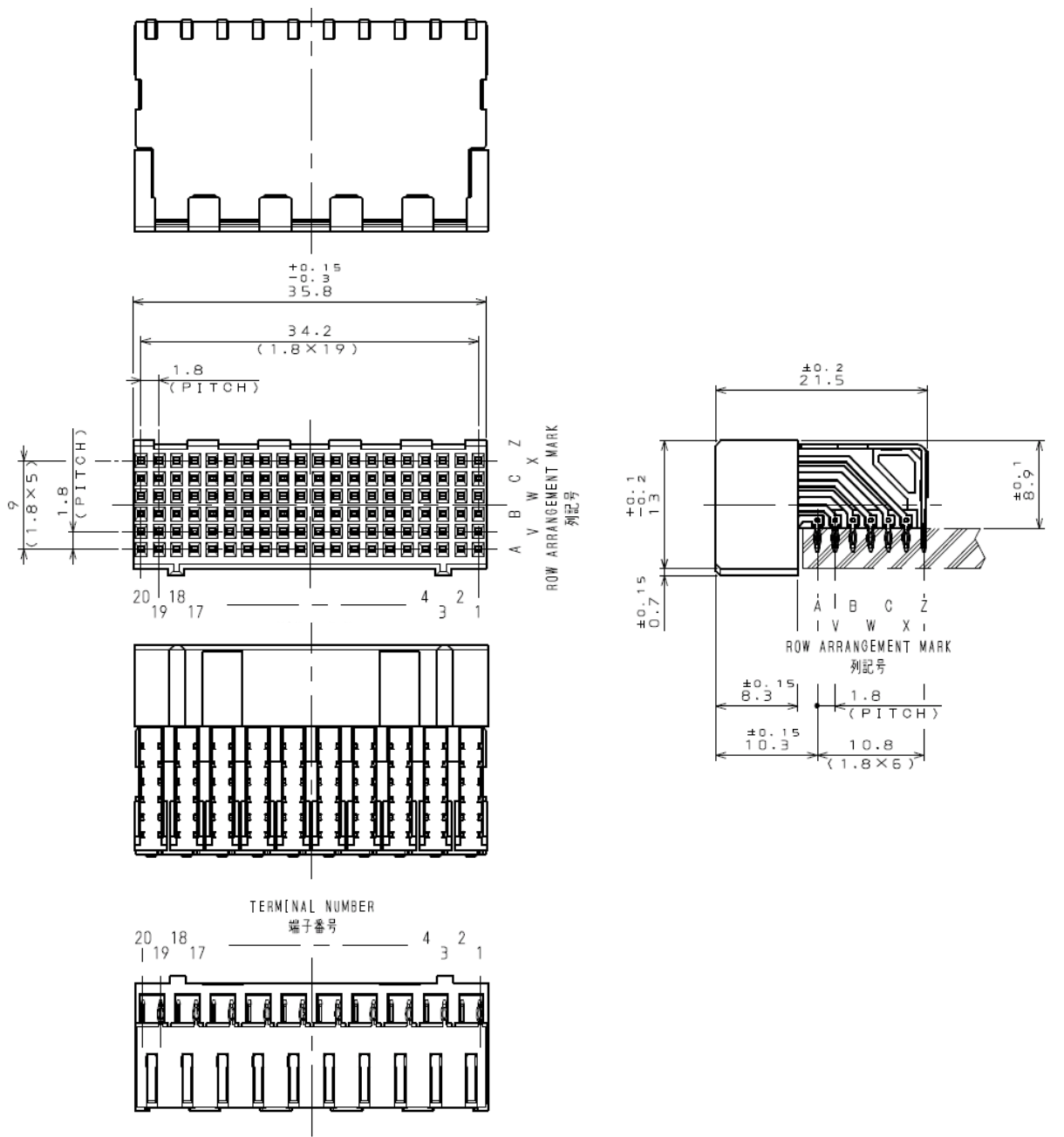

Applicable Board Dimensions (for reference)

MJ06-120MSP-A0-A (Pin Header Short)

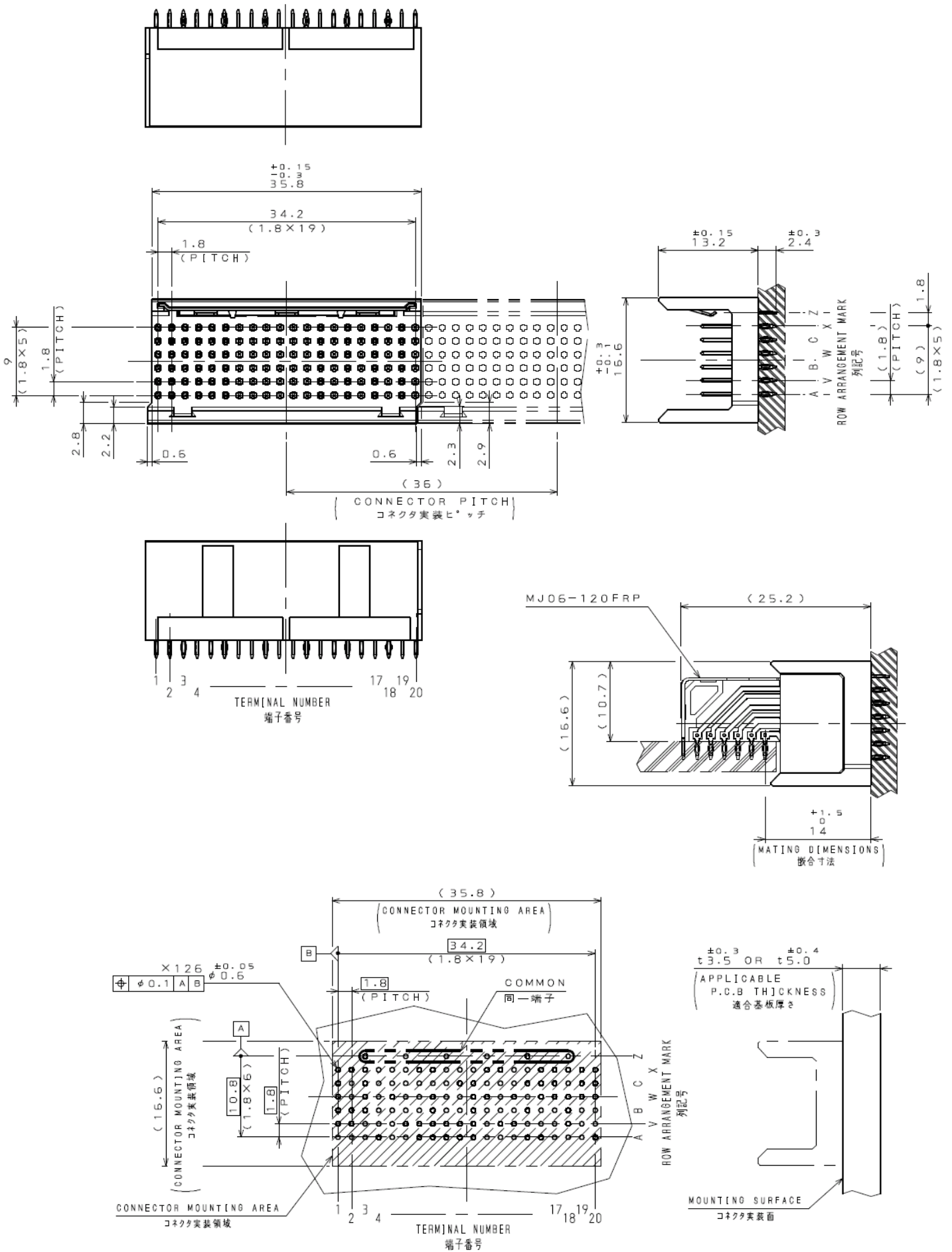

MJ06-120MSP-A3-A (Pin Header Long)

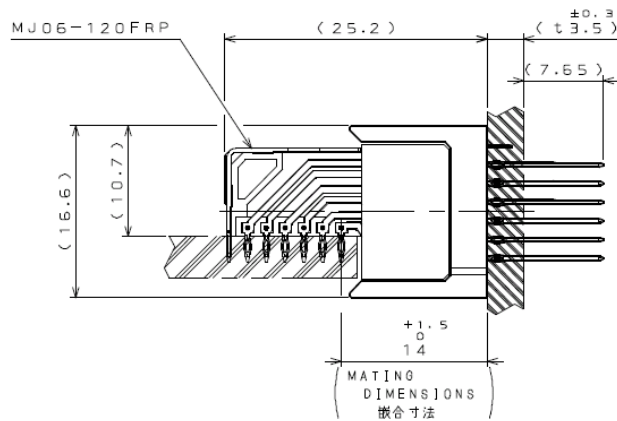
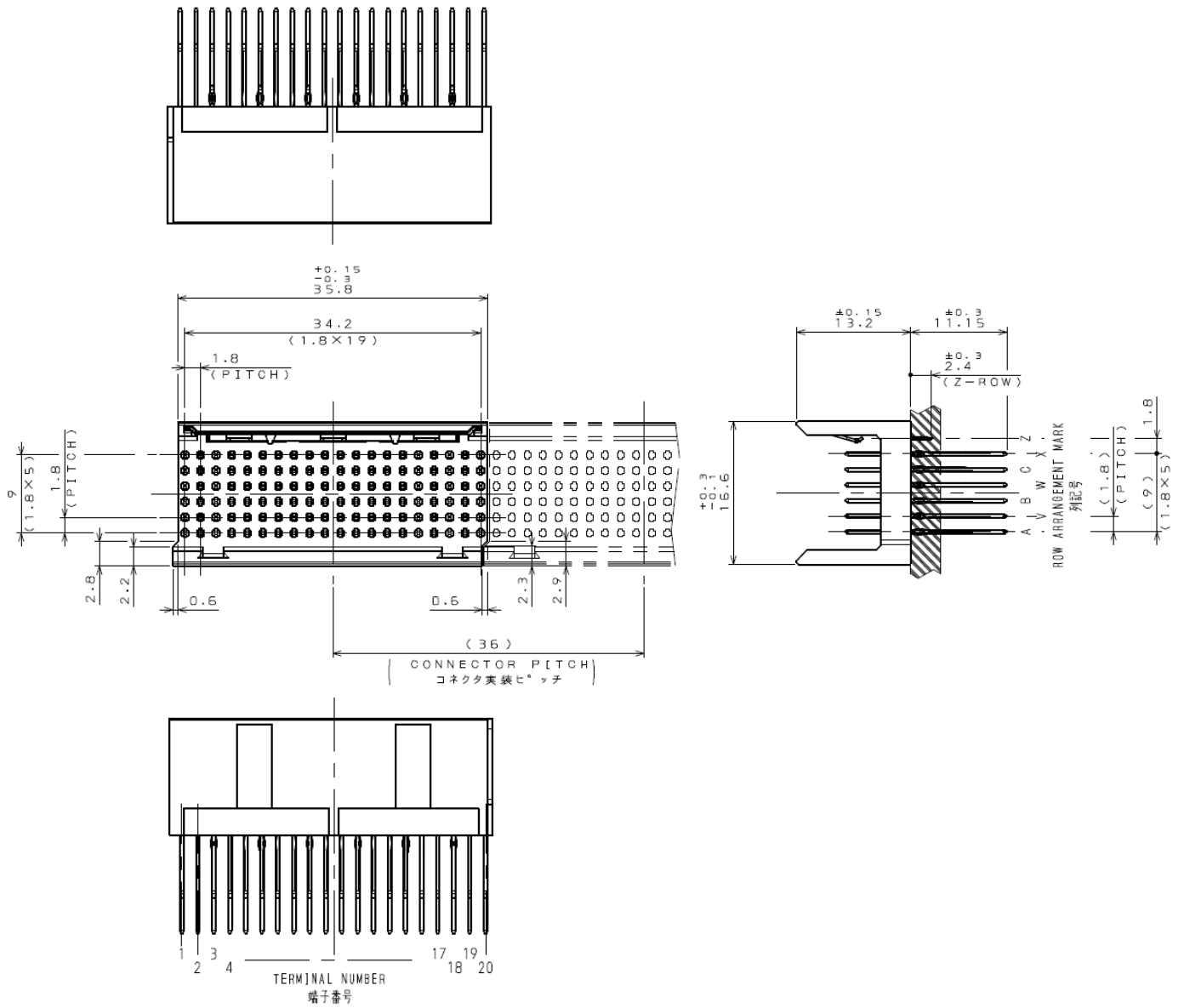

MJ06-120MSP-A5-A (Pin Header Long)

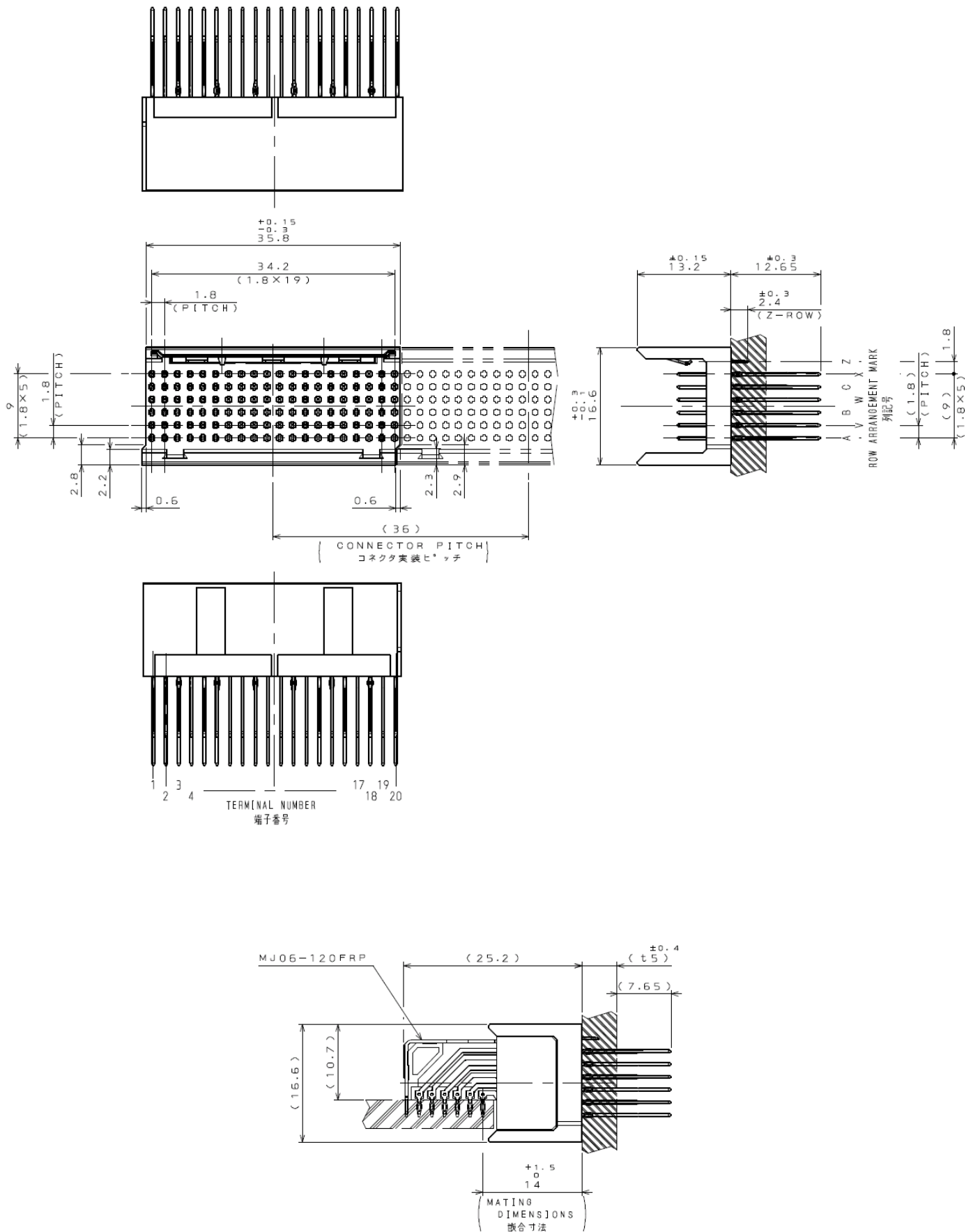

MJ06-120MRP-1 (Angle Pin Header)

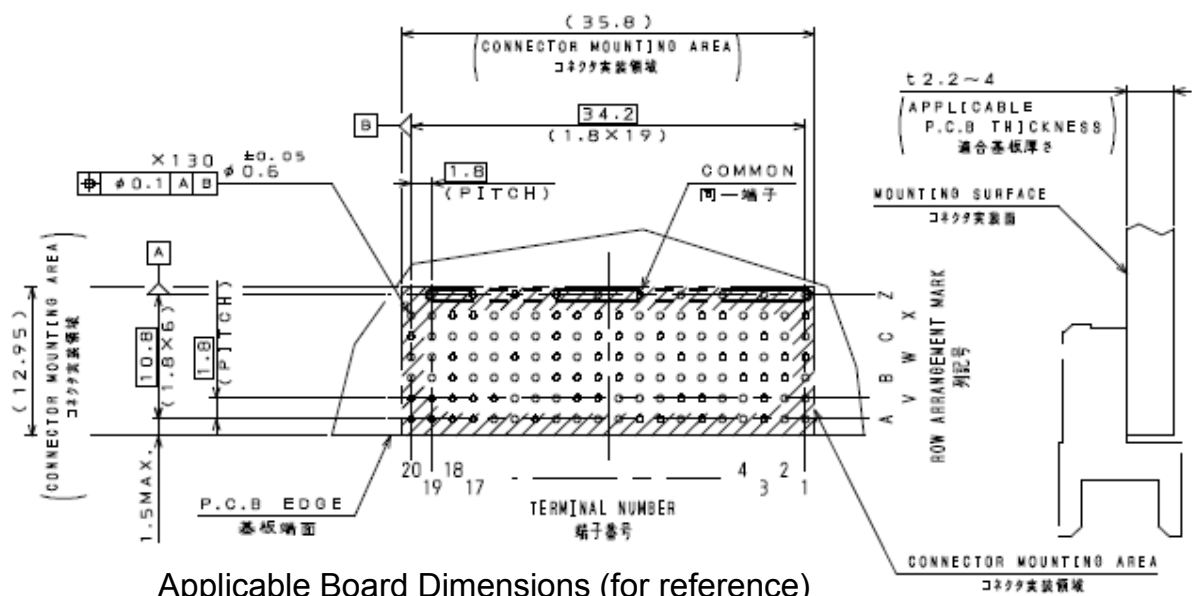
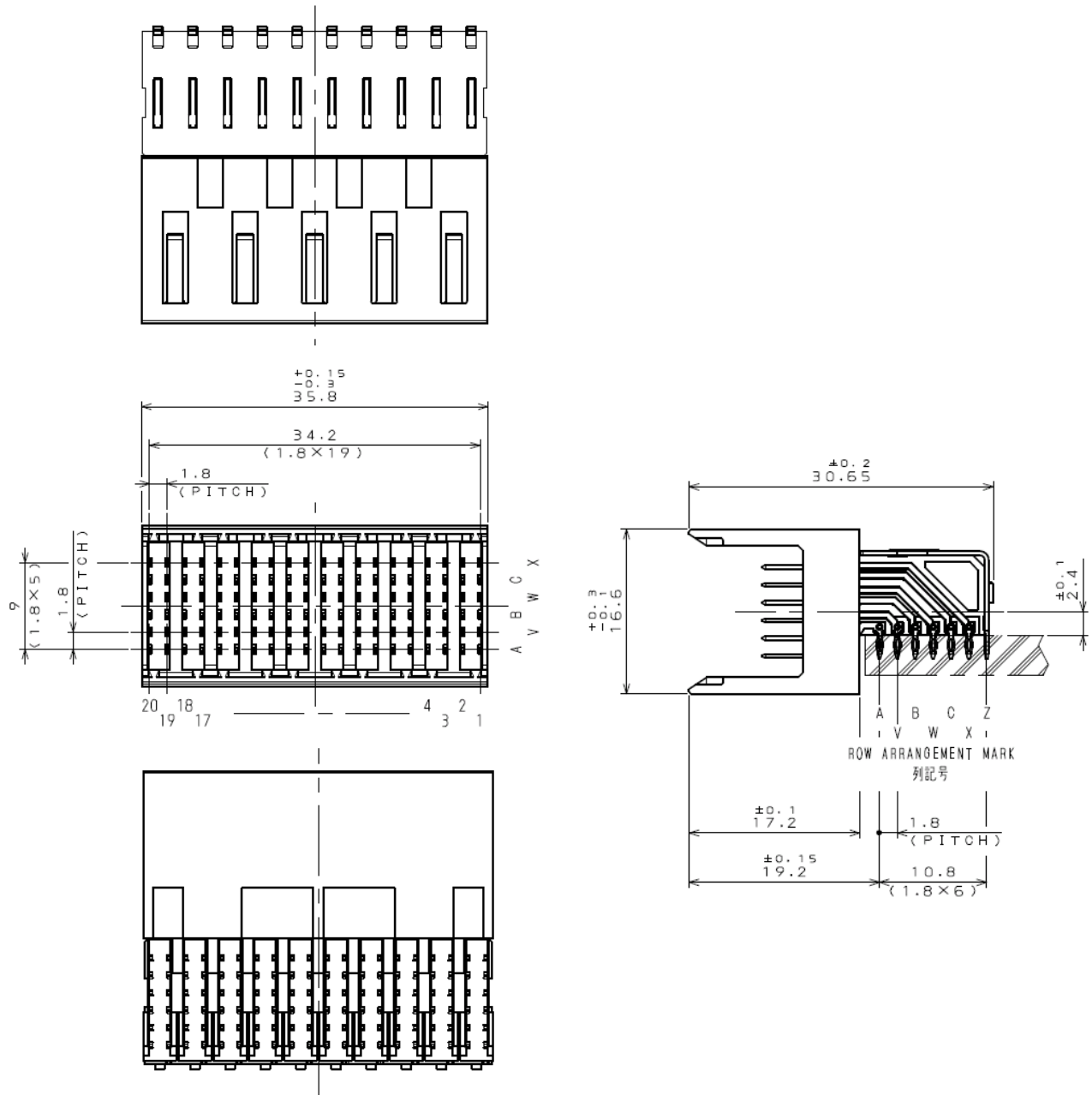

Applicable Board Dimensions (for reference)



MJ06-120S (Shroud)

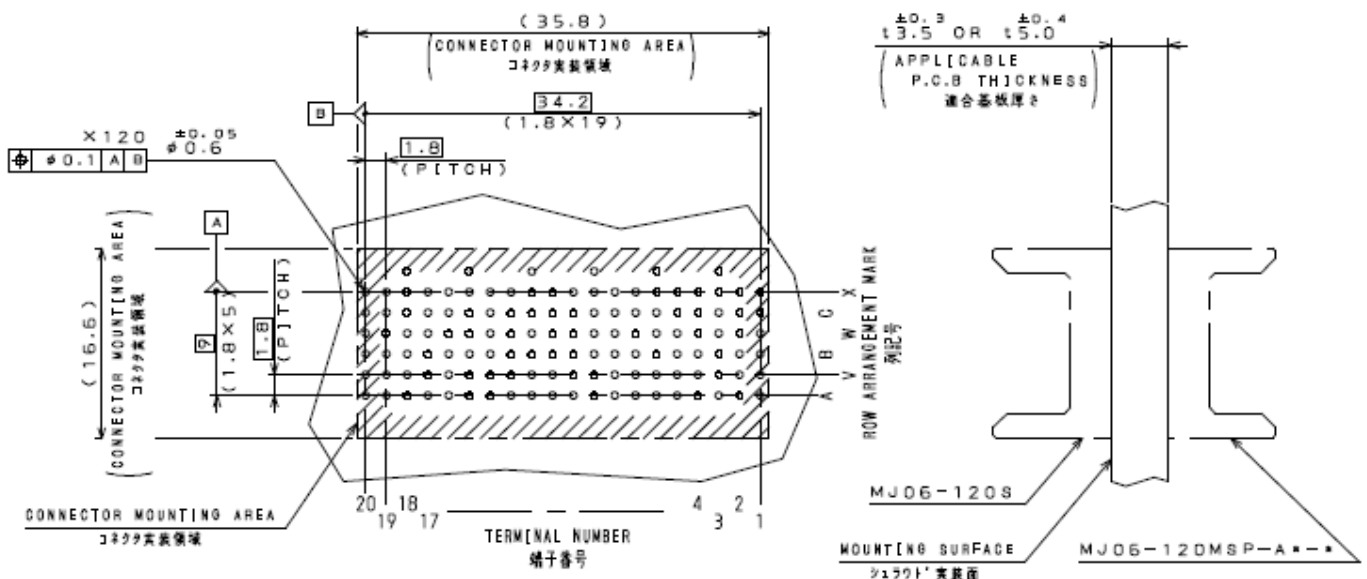
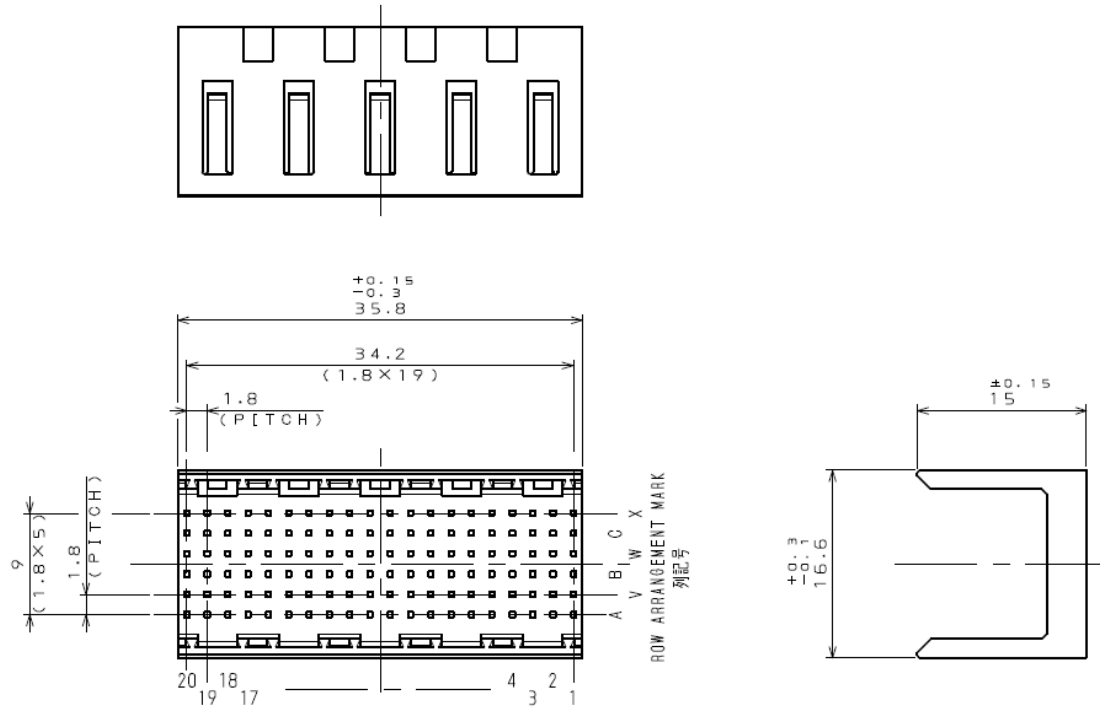

Applicable Board Dimensions (for reference)

SJ Drawing
------------

Configuration	Part Number	SJ Drawing No.	Specification
Angle Socket	MJ06-120FRP	SJ108443	JACS-10524
Straight Pin Header	MJ06-120MSP-A0-A	SJ108444	
	MJ06-120MSP-A3-A	SJ108446	
	MJ06-120MSP-A5-A	SJ108447	
Angle Pin Header	MJ06-120MRP-1	SJ108452	
Shroud	MJ06-120S	SJ108448	

**Notice:** Products shown in this leaflet are made for the applications listed below. However, if the above-mentioned products are to be used in aerospace devices, marine cable-connection devices, atomic power control systems, medical equipment for life-support systems, or any other specific application requiring extremely high reliability, please contact JAE for further information.

Recommended applications: computers, office machines, measuring devices, telecommunication devices (terminals, mobile devices), AV devices, household applications, FA devices, etc.

**Japan Aviation Electronics Industry, Limited**