

注：▲为重点检测尺寸

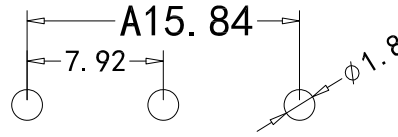
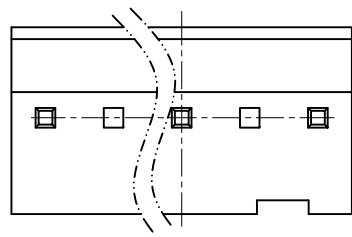

Recommand PCB Layout

■ SPECIFICATIONS

- Voltage rating: 250V AC/DC
- Current rating: 7A, AC/DC
- Withstanding Voltage: 1,500V AC/minute
- Insulation resistance: 1,000MΩ min
- Temperature range: -40°C to +105°C
- Contact resistance: 20mΩ max

■ WAFER

- Part No: CS-4001-05N2, 4V2N
- Poles: 5
- Material: PA66 UL 94-2, Natural
- Plating: Tin Plated
- Q' TY: 1, 000 pcs/PE Bag

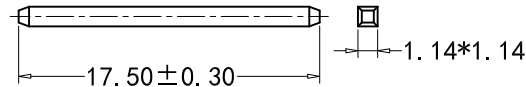
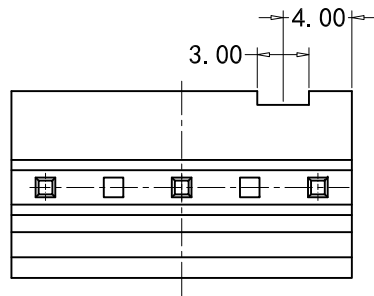
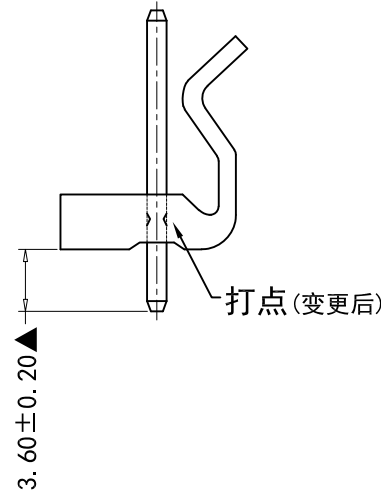
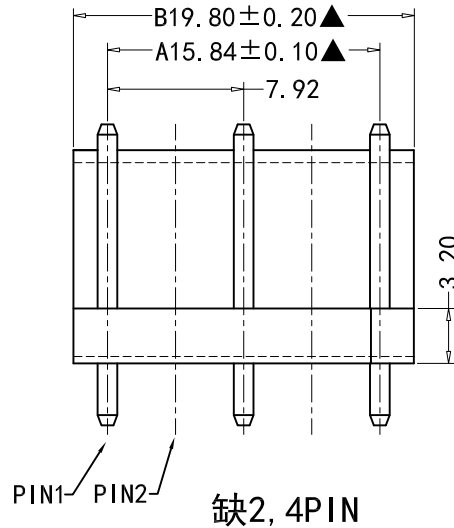
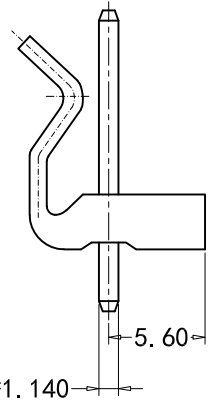

RoHS 2.0

注：未标准公差尺寸可参照公差对照表

本圖紙知識產權及版權由永丰盈电子有限公司所有, 未經書面許可不准擅自傳閱、复制和修改。本公司保留法律追究的权利。	类别	WAFER	品名	CS-4001-05N2, 4V2N	X.	±0.50	材料		单位	mm	SHEET 1 OF 1		
	版本	C/0	设计	李文畅	X.X	±0.40	颜色		比例	1:1	▲	修改内容	修改日期
	制定部门	工程课	绘制	李文畅	X.XX	±0.30	画法		数量		▲	缺口固定方向	2017-04-26
	工程图号	CST-A04001	审核	姚培柱	X.XXX	±0.20	<b>CST</b> 深圳永丰盈电子有限公司 SHENZHEN YONGFENGYING ENTERPRISE LTD.				▲	铜针打点	2022-05-03
	制定日期	2022-05-03	核准	周中湖	X.XXXX	±0.10					▲		