

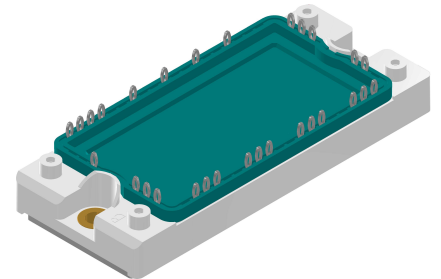
# Thyristor Module

3~ Rectifier	Brake Chopper
$V_{RRM} = 1600 \text{ V}$	$V_{CES} = 1200 \text{ V}$
$I_{DAV} = 240 \text{ A}$	$I_{C25} = 180 \text{ A}$
$I_{FSM} = 1500 \text{ A}$	$V_{CE(sat)} = 1.7 \text{ V}$

3~ Rectifier Bridge, half-controlled (high-side) + Brake Unit

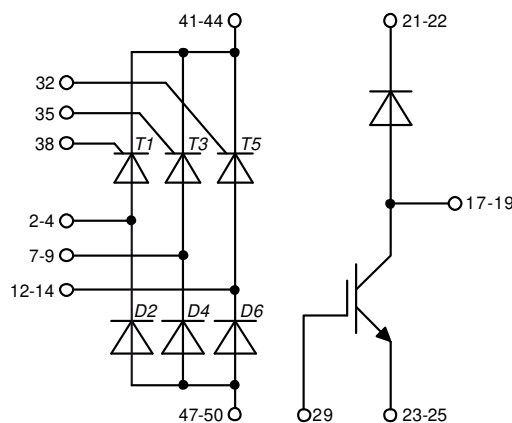
Part number

**MCMA240UI1600PED**



Backside: isolated

 E72873



## Features / Advantages:

- Package with DCB ceramic
- Improved temperature and power cycling
- Planar passivated chips
- Very low forward voltage drop
- Very low leakage current
- X2PT - 2nd generation Xtreme light Punch Through
- Rugged X2PT design results in:
  - short circuit rated for 10  $\mu\text{sec}$ .
  - very low gate charge
  - low EMI
  - square RBSOA @ 2x  $I_c$
- Thin wafer technology combined with X2PT design results in a competitive low  $V_{CE(sat)}$  and low thermal resistance

## Applications:

- 3~ Rectifier with brake unit for drive inverters

## Package: E2-Pack

- Isolation Voltage: 3600 V~
- Industry standard outline
- RoHS compliant
- PressFit-Pins for PCB mounting
- Height: 17 mm
- Base plate: Copper internally DCB isolated
- Advanced power cycling
- Phase Change Material available

## Disclaimer Notice

Information furnished is believed to be accurate and reliable. However, users should independently evaluate the suitability of and test each product selected for their own applications. Littelfuse products are not designed for, and may not be used in, all applications. Read complete Disclaimer Notice at [www.littelfuse.com/disclaimer-electronics](http://www.littelfuse.com/disclaimer-electronics).

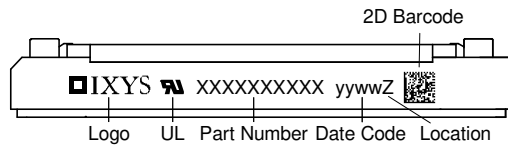


Rectifier			Ratings			
Symbol	Definition	Conditions	min.	typ.	max.	Unit
$V_{RSM/DSM}$	max. non-repetitive reverse/forward blocking voltage	$T_{VJ} = 25^{\circ}C$			1700	V
$V_{RRM/DRM}$	max. repetitive reverse/forward blocking voltage	$T_{VJ} = 25^{\circ}C$			1600	V
$I_{RD}$	reverse current, drain current	$V_{R/D} = 1600 V$	$T_{VJ} = 25^{\circ}C$		100	$\mu A$
		$V_{R/D} = 1600 V$	$T_{VJ} = 150^{\circ}C$		20	mA
$V_T$	forward voltage drop	$I_T = 80 A$	$T_{VJ} = 25^{\circ}C$		1.27	V
		$I_T = 240 A$			1.89	V
		$I_T = 80 A$	$T_{VJ} = 125^{\circ}C$		1.26	V
		$I_T = 240 A$			2.05	V
$I_{DAV}$	bridge output current	$T_C = 80^{\circ}C$ rectangular $d = 120^{\circ}$	$T_{VJ} = 150^{\circ}C$		240	A
$V_{T0}$	threshold voltage	} for power loss calculation only	$T_{VJ} = 150^{\circ}C$		0.83	V
$r_T$	slope resistance				5.3	m $\Omega$
$R_{thJC}$	thermal resistance junction to case				0.4	K/W
$R_{thCH}$	thermal resistance case to heatsink			0.1		K/W
$P_{tot}$	total power dissipation		$T_C = 25^{\circ}C$		312	W
$I_{TSM}$	max. forward surge current	$t = 10 ms; (50 Hz), sine$	$T_{VJ} = 45^{\circ}C$		1.50	kA
		$t = 8,3 ms; (60 Hz), sine$	$V_R = 0 V$		1.62	kA
		$t = 10 ms; (50 Hz), sine$	$T_{VJ} = 150^{\circ}C$		1.28	kA
		$t = 8,3 ms; (60 Hz), sine$	$V_R = 0 V$		1.38	kA
$I^2t$	value for fusing	$t = 10 ms; (50 Hz), sine$	$T_{VJ} = 45^{\circ}C$		11.3	kA <sup>2</sup> s
		$t = 8,3 ms; (60 Hz), sine$	$V_R = 0 V$		10.9	kA <sup>2</sup> s
		$t = 10 ms; (50 Hz), sine$	$T_{VJ} = 150^{\circ}C$		8.13	kA <sup>2</sup> s
		$t = 8,3 ms; (60 Hz), sine$	$V_R = 0 V$		7.87	kA <sup>2</sup> s
$C_J$	junction capacitance	$V_R = 400 V f = 1 MHz$	$T_{VJ} = 25^{\circ}C$		74	pF
$P_{GM}$	max. gate power dissipation	$t_p = 30 \mu s$	$T_C = 150^{\circ}C$		10	W
		$t_p = 300 \mu s$			5	W
$P_{GAV}$	average gate power dissipation				0.5	W
$(di/dt)_{cr}$	critical rate of rise of current	$T_{VJ} = 150^{\circ}C; f = 50 Hz$ repetitive, $I_T = 240 A$			150	A/ $\mu s$
		$t_p = 200 \mu s; di_G/dt = 0.45 A/\mu s;$ $I_G = 0.45 A; V = \frac{2}{3} V_{DRM}$ non-repet., $I_T = 80 A$			500	A/ $\mu s$
$(dv/dt)_{cr}$	critical rate of rise of voltage	$V = \frac{2}{3} V_{DRM}$ $R_{GK} = \infty; \text{method 1 (linear voltage rise)}$	$T_{VJ} = 150^{\circ}C$		1000	V/ $\mu s$
$V_{GT}$	gate trigger voltage	$V_D = 6 V$	$T_{VJ} = 25^{\circ}C$		1.5	V
			$T_{VJ} = -40^{\circ}C$		1.6	V
$I_{GT}$	gate trigger current	$V_D = 6 V$	$T_{VJ} = 25^{\circ}C$		95	mA
			$T_{VJ} = -40^{\circ}C$		200	mA
$V_{GD}$	gate non-trigger voltage	$V_D = \frac{2}{3} V_{DRM}$	$T_{VJ} = 150^{\circ}C$		0.2	V
$I_{GD}$	gate non-trigger current				10	mA
$I_L$	latching current	$t_p = 10 \mu s$	$T_{VJ} = 25^{\circ}C$		450	mA
		$I_G = 0.45 A; di_G/dt = 0.45 A/\mu s$				
$I_H$	holding current	$V_D = 6 V R_{GK} = \infty$	$T_{VJ} = 25^{\circ}C$		200	mA
$t_{gd}$	gate controlled delay time	$V_D = \frac{1}{2} V_{DRM}$ $I_G = 0.45 A; di_G/dt = 0.45 A/\mu s$	$T_{VJ} = 25^{\circ}C$		2	$\mu s$
$t_q$	turn-off time	$V_R = 100 V; I_T = 80 A; V = \frac{2}{3} V_{DRM}$ $di/dt = 10 A/\mu s dv/dt = 20 V/\mu s t_p = 200 \mu s$	$T_{VJ} = 125^{\circ}C$		150	$\mu s$



Brake IGBT + Diode				Ratings			
Symbol	Definition	Conditions	min.	typ.	max.	Unit	
$V_{CES}$	collector emitter voltage				1200	V	
$V_{GES}$	max. DC gate voltage				$\pm 20$	V	
$V_{GEM}$	max. transient gate emitter voltage				$\pm 30$	V	
$I_{C25}$	collector current				180	A	
$I_{C80}$					140	A	
$P_{tot}$	total power dissipation				500	W	
$V_{CE(sat)}$	collector emitter saturation voltage	$I_C = 100 \text{ A}; V_{GE} = 15 \text{ V}$			1.7	V	
					1.9	V	
$V_{GE(th)}$	gate emitter threshold voltage	$I_C = 4 \text{ mA}; V_{GE} = V_{CE}$	6	6.8	7.5	V	
$I_{CES}$	collector emitter leakage current	$V_{CE} = V_{CES}; V_{GE} = 0 \text{ V}$			0.1	mA	
					0.1	mA	
$I_{GES}$	gate emitter leakage current	$V_{GE} = \pm 20 \text{ V}$			500	nA	
$Q_{G(on)}$	total gate charge	$V_{CE} = 600 \text{ V}; V_{GE} = 15 \text{ V}; I_C = 100 \text{ A}$		340		nC	
$t_{d(on)}$	turn-on delay time	inductive load $V_{CE} = 600 \text{ V}; I_C = 100 \text{ A}$ $V_{GE} = \pm 15 \text{ V}; R_G = 6.8 \Omega$		230		ns	
$t_r$	current rise time			70		ns	
$t_{d(off)}$	turn-off delay time			380		ns	
$t_f$	current fall time			230		ns	
$E_{on}$	turn-on energy per pulse			12.5		mJ	
$E_{off}$	turn-off energy per pulse			11.5		mJ	
<b>RBSOA</b>	reverse bias safe operating area	$V_{GE} = \pm 15 \text{ V}; R_G = 6.8 \Omega$					
$I_{CM}$		$V_{CEK} = 1200 \text{ V}$			300	A	
<b>SCSOA</b>	short circuit safe operating area	$V_{CEK} = 1200 \text{ V}$					
$t_{SC}$	short circuit duration	$V_{CE} = 720 \text{ V}; V_{GE} = \pm 15$			10	$\mu\text{s}$	
$I_{SC}$	short circuit current	$R_G = 6.8 \Omega; \text{non-repetitive}$		450		A	
$R_{thJC}$	thermal resistance junction to case				0.25	K/W	
$R_{thCH}$	thermal resistance case to heatsink			0.10		K/W	
<b>Brake Diode</b>							
$V_{RRM}$	max. repetitive reverse voltage				1200	V	
$I_{F25}$	forward current				88	A	
$I_{F80}$					59	A	
$V_F$	forward voltage	$I_F = 60 \text{ A}$			2.20	V	
					1.95	V	
$I_R$	reverse current	$V_R = V_{RRM}$			0.1	mA	
					1.2	mA	
$Q_{rr}$	reverse recovery charge	$V_R = 600 \text{ V}$ $-di_f/dt = 900 \text{ A}/\mu\text{s}$ $I_F = 60 \text{ A}; V_{GE} = 0 \text{ V}$		9.6		$\mu\text{C}$	
$I_{RM}$	max. reverse recovery current			47		A	
$t_{rr}$	reverse recovery time			450		ns	
$E_{rec}$	reverse recovery energy			3		mJ	
$R_{thJC}$	thermal resistance junction to case				0.6	K/W	
$R_{thCH}$	thermal resistance case to heatsink			0.1		K/W	

Package E2-Pack		Ratings				
Symbol	Definition	Conditions	min.	typ.	max.	Unit
$I_{RMS}$	RMS current	per terminal			50	A
$T_{VJ}$	virtual junction temperature		-40		150	°C
$T_{op}$	operation temperature		-40		125	°C
$T_{stg}$	storage temperature		-40		125	°C
<b>Weight</b>				176		g
$M_D$	mounting torque		3		6	Nm
$d_{Spp/App}$	creepage distance on surface / striking distance through air	terminal to terminal	6.0			mm
$d_{Spb/Appb}$		terminal to backside	12.0			mm
$V_{ISOL}$	isolation voltage	t = 1 second	3600			V
		t = 1 minute	3000			V



### Part description

M = Module  
 C = Thyristor (SCR)  
 M = Thyristor  
 A = (up to 1800V)  
 240 = Current Rating [A]  
 UI = 3- Rectifier Bridge, half-controlled (high-side) + Brake Unit  
 1600 = Reverse Voltage [V]  
 P = PressFit-Pin  
 ED = E2-Pack  
 - = Hyphen  
 PC = Phase Change Material

Ordering	Ordering Number	Marking on Product	Delivery Mode	Quantity	Code No.
Standard	MCMA240UI1600PED	MCMA240UI1600PED	Blister	28	516002
Alternative	MCMA240UI1600PED-PC	MCMA240UI1600PED	Blister	28	518136

### Equivalent Circuits for Simulation

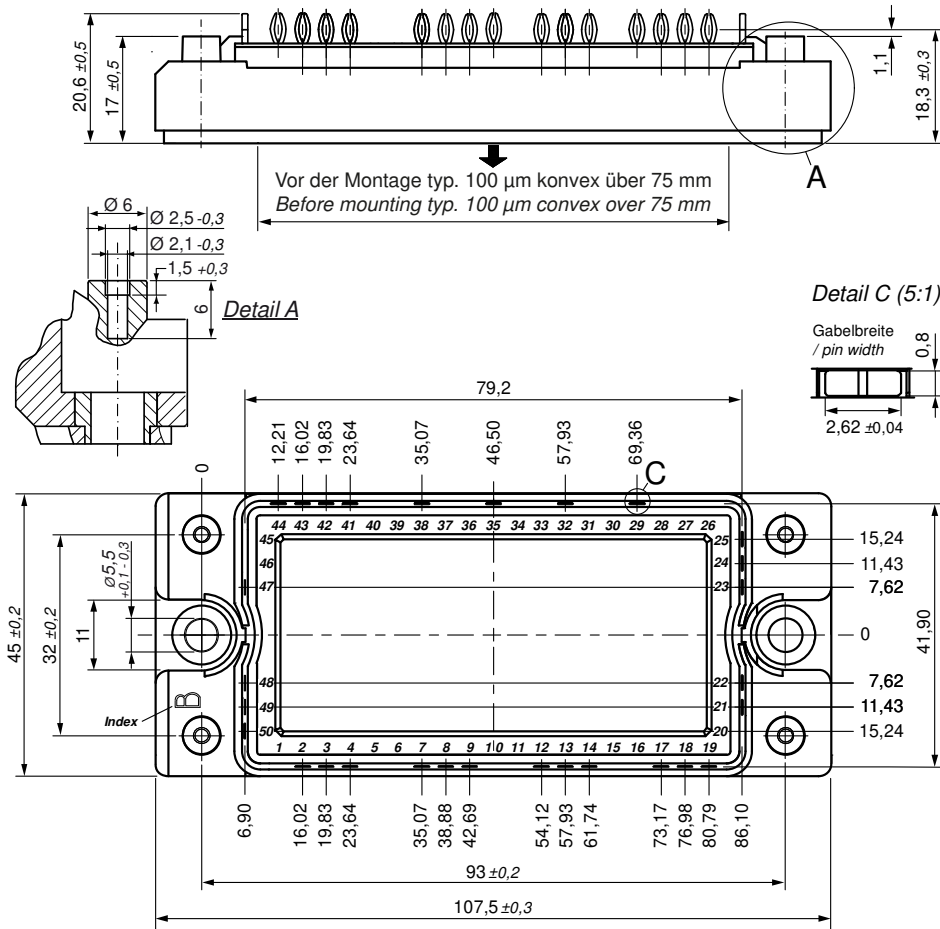
\* on die level

$T_{VJ} = 150^{\circ}\text{C}$

		Thyristor	Brake IGBT +	Brake Diode	
$V_0$	threshold voltage	0.83	1.2	1.25	V
$R_0$	slope resistance *	2.7	11.6	8.5	mΩ



**Outlines E2-Pack**

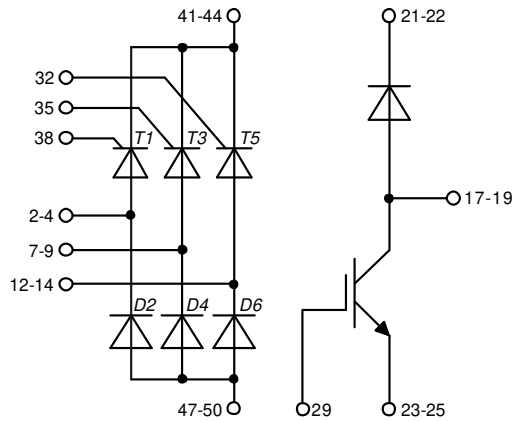


**Bemerkung / Note:**

- Nicht tolerierte Maße nach / Measure without tolerances according DIN ISO 2768-T1-m
- PCB-Lochmuster / PCB hole pattern: **see pin position**
- Toleranz Pin-Position und PCB-Lochmuster / Tolerance of pin position and PCB hole pattern:  $\oplus 0.1$
- Bohrlochdurchmesser / Diameter of drill: **Ø 2.35 mm**
- Endlochdurchmesser / Diameter of plated holes: **Ø 2.14 - 2.29 mm** (Cu thickness in via typ. 50 µm)
- Beschichtung / Plating: **chem. Sn max. 15 µm**
- Einpresskraft / Insert Force: per terminal with a typ. insert speed of 7 mm/s: **typ. 90 N**
- Weitere Angaben / Further information: [www.ixys.com](http://www.ixys.com) **Application note IXAN0077**
- Montageanleitung / Mounting instruction: [www.ixys.com](http://www.ixys.com) **Application note IXAN0024**

**Detail A:** PCB-Montage / Mounting on PCB<sup>L</sup>

- Empfohlene, selbstschneidende Schraube / Recommended, self-tapping screw: **EJOT PT®** (Größe / size: **K25**)<sup>L</sup>
- Max. Schraubenlänge / Max. screw length: **PCB-Dicke / thickness + 6 mm** (max. Lochtiefe / hole depth)<sup>L</sup>
- Empfohlenes Drehmoment / Recommended mounting torque: **1.5 Nm**



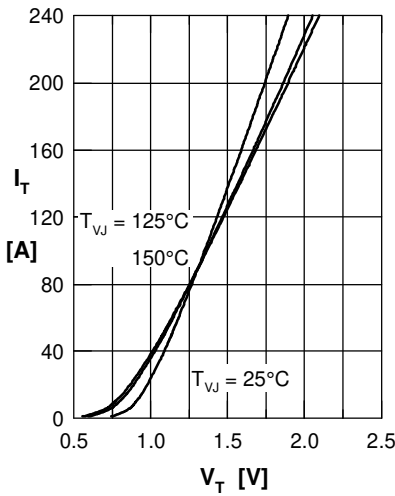
**Thyristor**


Fig. 1 Forward characteristics

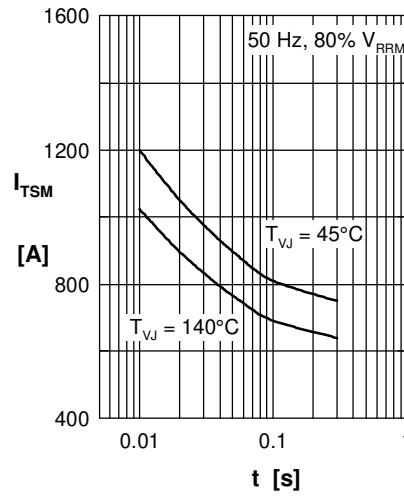
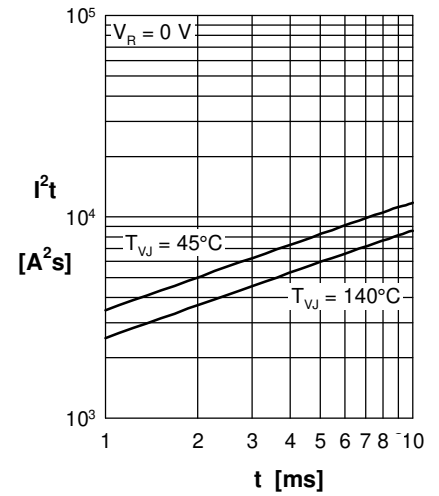
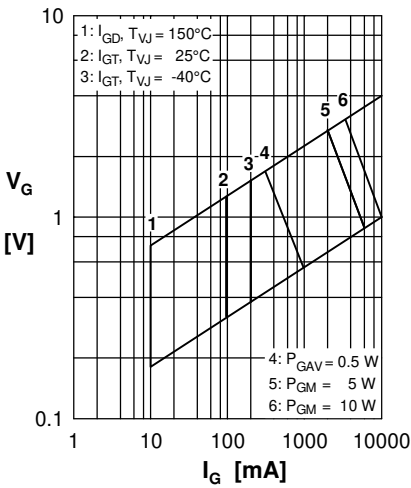

 Fig. 2 Surge overload current  
 $I_{TSM}$ : crest value,  $t$ : duration

 Fig. 3  $I^2t$  versus time (1-10 s)


Fig. 4 Gate voltage &amp; gate current

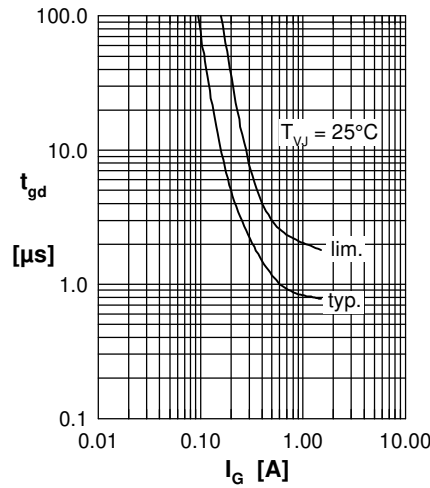
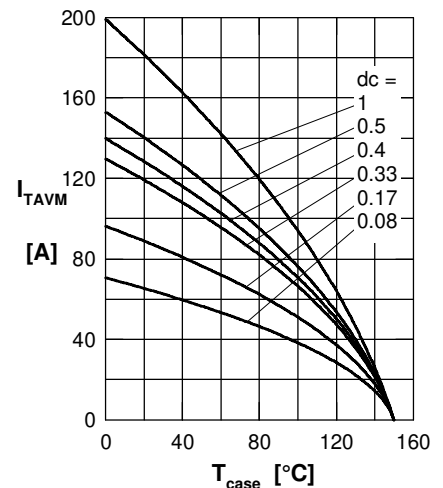

 Fig. 5 Gate controlled delay time  $t_{gd}$ 


Fig. 6 Max. forward current at case temperature

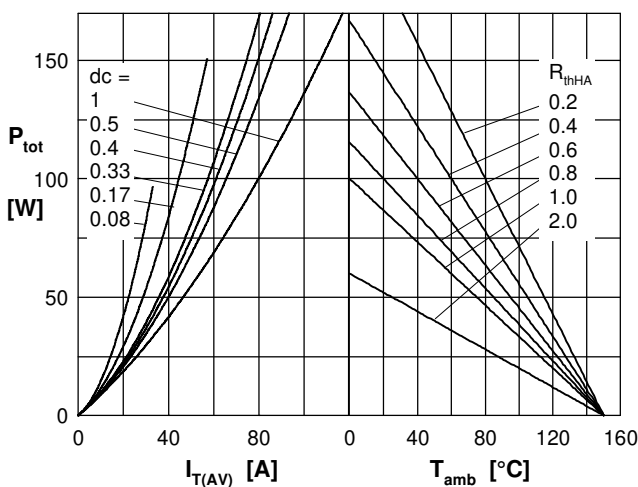
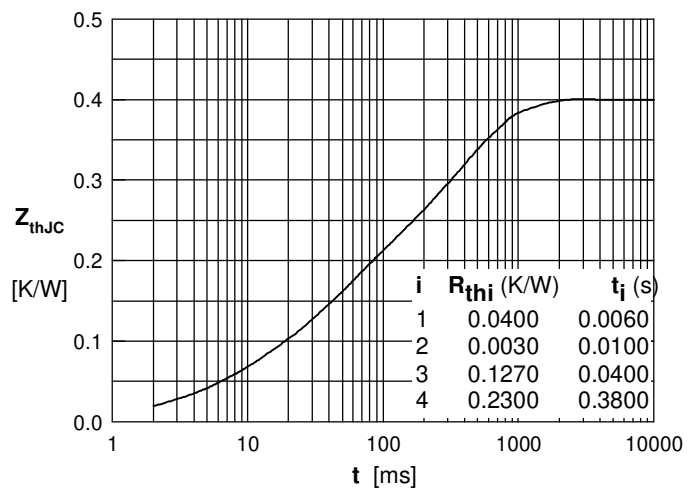

 Fig. 7a Power dissipation versus direct output current  
 Fig. 7b and ambient temperature


Fig. 8 Transient thermal impedance junction to case

## Brake IGBT + Diode

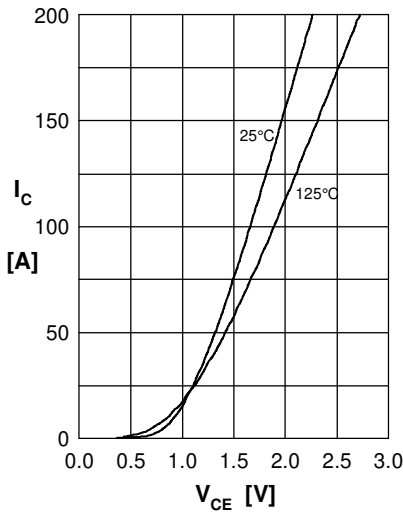


Fig.1 Output characteristics IGBT



Fig.2 Typ. output characteristics IGBT

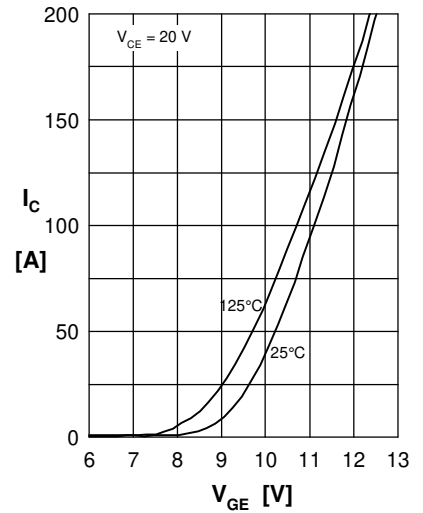


Fig.3 Typ. transfer charact. IGBT

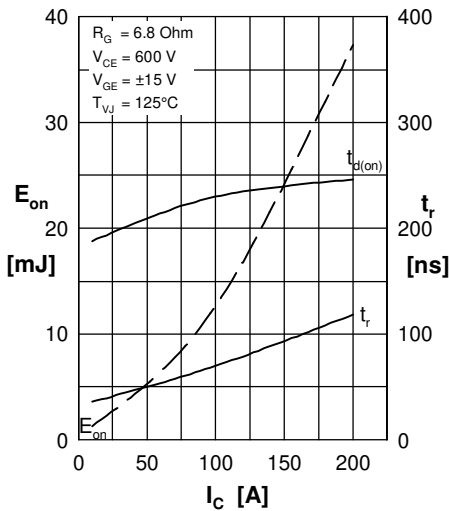


Fig.4 Typ. turn-on energy & switch. times vs. collector current

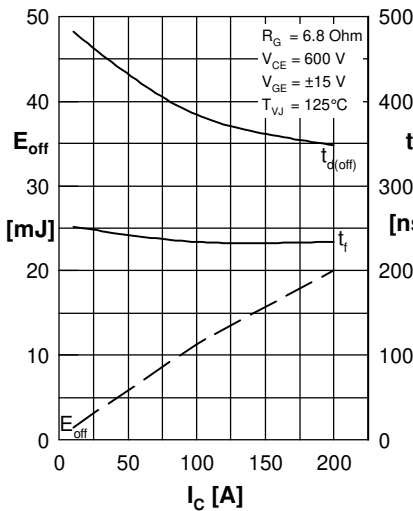


Fig.5 Typ. turn-off energy & switch. times vs. collector current

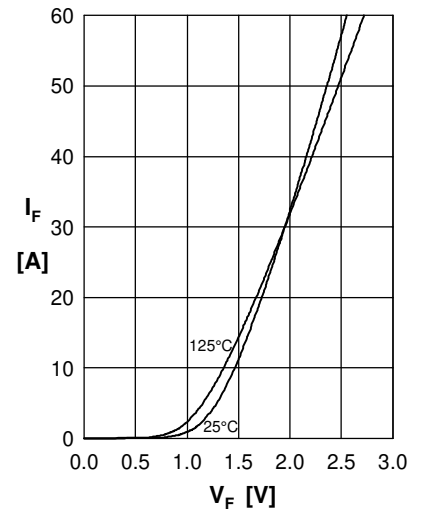


Fig.6 Typ. forward current versus  $V_F$

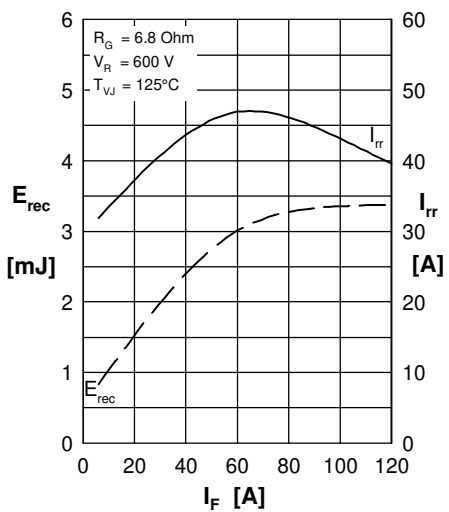


Fig.7 Typ. reverse recovery characteristics Diode

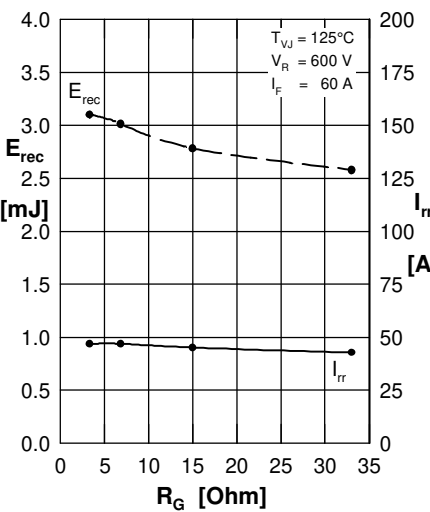


Fig.8 Typ. reverse recovery characteristics Diode

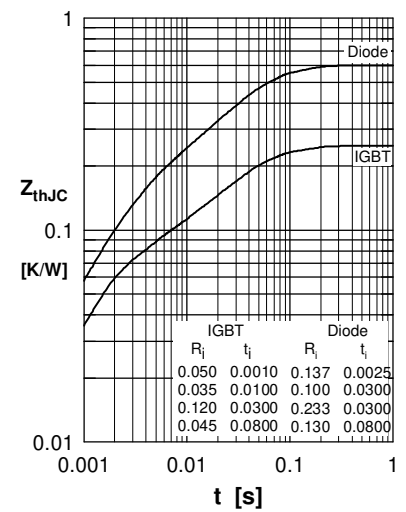


Fig.9 Transient thermal resistance junction to case