

#### Description

Excellent unidirectional switches for phase control applications such as heating and motor speed controls.

Sensitive gate SCRs are easily triggered with microAmps of current as furnished by sense coils, proximity switches, and microprocessors.

#### Features & Benefits

- RoHS compliant
- Glass – passivated junctions
- Voltage capability up to 600 V
- Surge capability up to 30 A

#### Applications

Typical applications are capacitive discharge systems for strobe lights, nailers, staplers and gas engine ignition. Also controls for power tools, home/brown goods and white goods appliances.

#### Main Features

Symbol	Value	Unit
$I_{T(RMS)}$	4	A
$V_{DRM}/V_{RRM}$	400 or 600	V
$I_{GT}$	50 or 200	$\mu A$

#### Additional Information



Datasheet

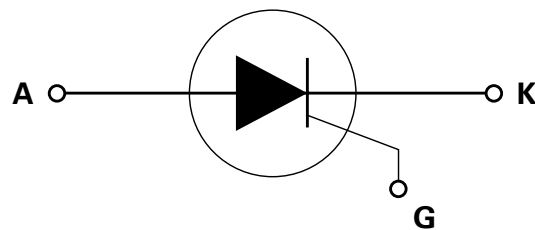


Resources



Samples

#### Schematic Symbol



#### Absolute Maximum Ratings

Symbol	Parameter	Test Conditions	Value	Unit
$I_{T(RMS)}$	RMS on-state current	$T_C = 95^\circ C$	4	A
$I_{T(AV)}$	Average on-state current	$T_C = 95^\circ C$	2.5	A
$I_{TSM}$	Peak non-repetitive surge current	single half cycle; $f = 50\text{Hz}$ ; $T_J$ (initial) = $25^\circ C$	25	A
		single half cycle; $f = 60\text{Hz}$ ; $T_J$ (initial) = $25^\circ C$	30	
$I^2t$	$I^2t$ Value for fusing	$t_p = 8.3 \text{ ms}$	3.7	$A^2s$
$di/dt$	Critical rate of rise of on-state current	$f = 60\text{Hz}$ ; $T_J = 110^\circ C$	50	$A/\mu s$
$I_{GM}$	Peak gate current	$T_J = 110^\circ C$	1	A
$P_{G(AV)}$	Average gate power dissipation	$T_J = 110^\circ C$	0.1	W
$T_{stg}$	Storage temperature range		-40 to 150	$^\circ C$
$T_J$	Operating junction temperature range		-40 to 110	$^\circ C$

### Electrical Characteristics — ( $T_J = 25^\circ\text{C}$ , unless otherwise specified)

Symbol	Test Conditions		Value		Unit
			Sxx04xS1	Sxx04xS2	
$I_{GT}$	$V_D = 6V; R_L = 100\ \Omega$	MAX.	50	200	$\mu\text{A}$
$V_{GT}$		MAX.	0.8		V
dv/dt	$V_D = V_{DRM}; R_{GK} = 1k\Omega$	TYP.	8		V/ $\mu\text{s}$
$V_{GD}$	$V_D = V_{DRM}; R_L = 3.3\ k\Omega; T_J = 110^\circ\text{C}$	MIN.	0.2		V
$V_{GRM}$	$I_{GR} = 10\mu\text{A}$	MIN.	6		V
$I_H$	$I_T = 20\text{mA (initial)}; R_{GK} = 1k\text{ohm}$	MAX.	4	6	mA
$t_q$	(1)	MAX.	50		$\mu\text{s}$
$t_{gt}$	$I_G = 2 \times I_{GT}; PW = 15\mu\text{s}; I_T = 8\text{A}$	TYP.	3	4	$\mu\text{s}$

Notes :

xx = voltage, x = package

(1)  $I_T=2\text{A}; t_q=50\mu\text{s}; dv/dt=5\text{V}/\mu\text{s}; di/dt=10\text{A}/\mu\text{s}$

### Static Characteristics

Symbol	Test Conditions		Value	Unit
$V_{TM}$	Sxx04xSy $I_T = 8\text{A}; t_p = 380\ \mu\text{s}$	MAX.	1.6	V
$I_{DRM} / I_{RRM}$	$V_{DRM} / V_{RRM} - R_{GK} = 1k\text{ohm}$	$T_J = 25^\circ\text{C}$	2	$\mu\text{A}$
		$T_J = 110^\circ\text{C}$	100	

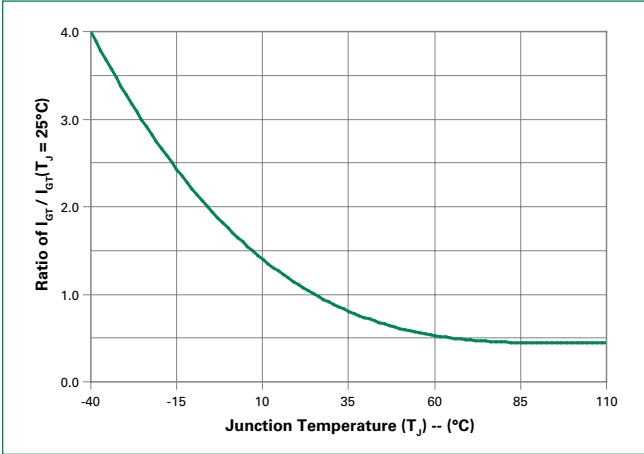
Note : xx or z = voltage, x = package, y = sensitivity

### Thermal Resistances

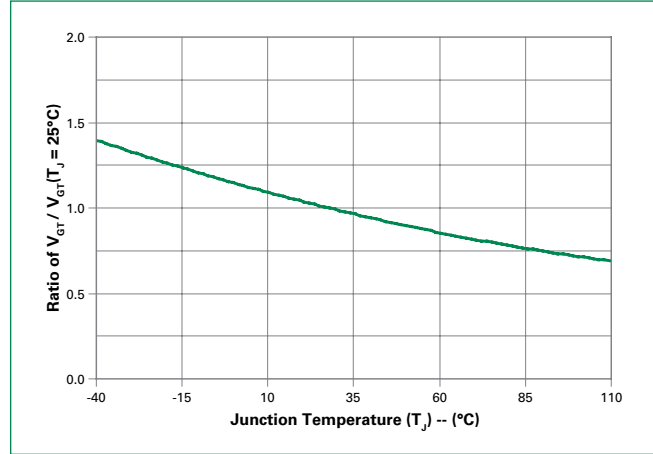
Symbol	Parameter		Value	Unit
$R_{\theta(J-C)}$	Junction to case (AC)	Sxx04VSy	3.8	$^\circ\text{C}/\text{W}$
		Sxx04DSy	3.0	
$R_{\theta(J-A)}$	Junction to ambient	Sxx04VSy	85	$^\circ\text{C}/\text{W}$

Notes: xx = voltage, y = sensitivity

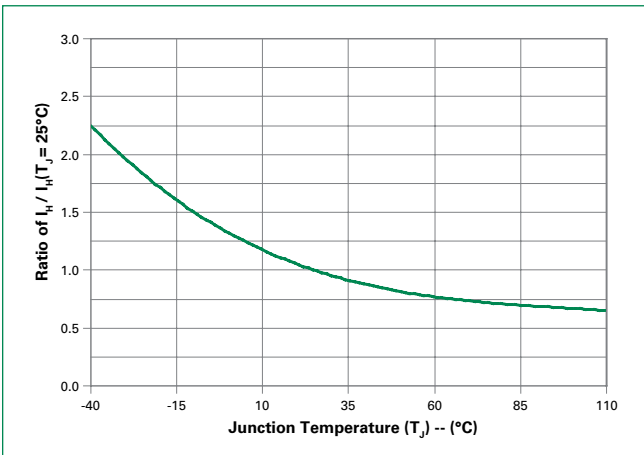
**Figure 1: Normalized DC Gate Trigger Current vs. Junction Temperature**



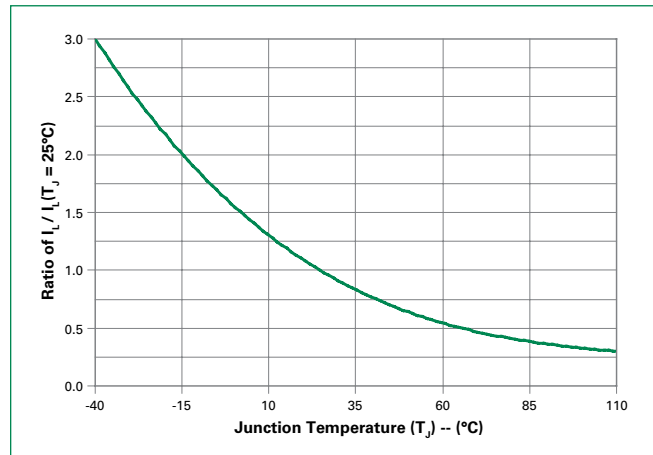
**Figure 2: Normalized DC Gate Trigger Voltage vs. Junction Temperature**



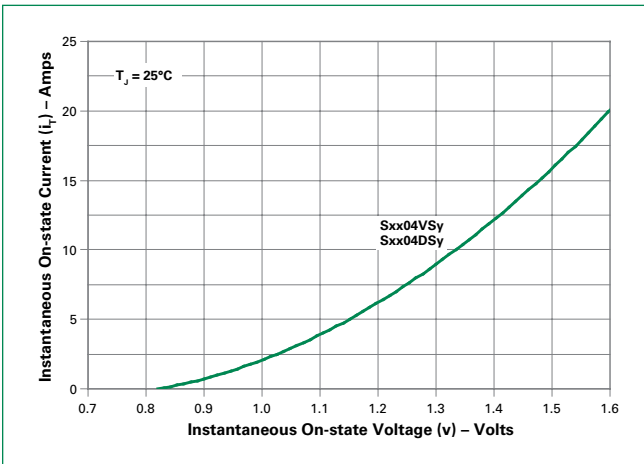
**Figure 3: Normalized DC Holding Current vs. Junction Temperature**



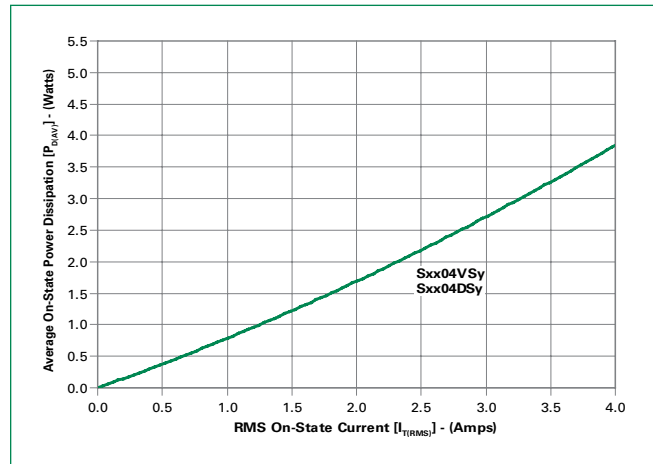
**Figure 4: Normalized DC Latching Current vs. Junction Temperature**



**Figure 5: On-State Current vs. On-State Voltage (Typical)**

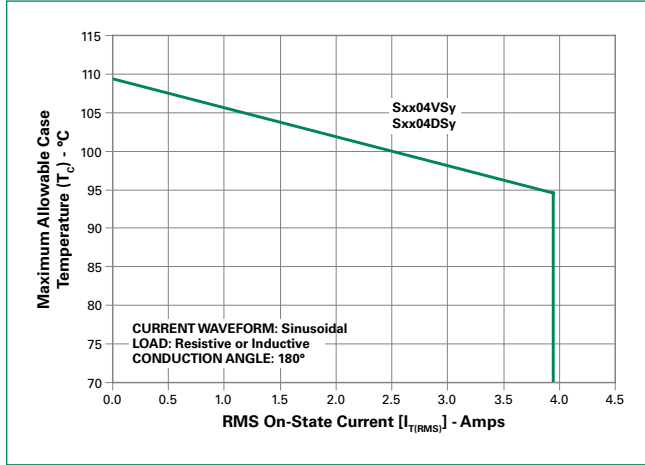


**Figure 6: Power Dissipation (Typical) vs. RMS On-State Current**

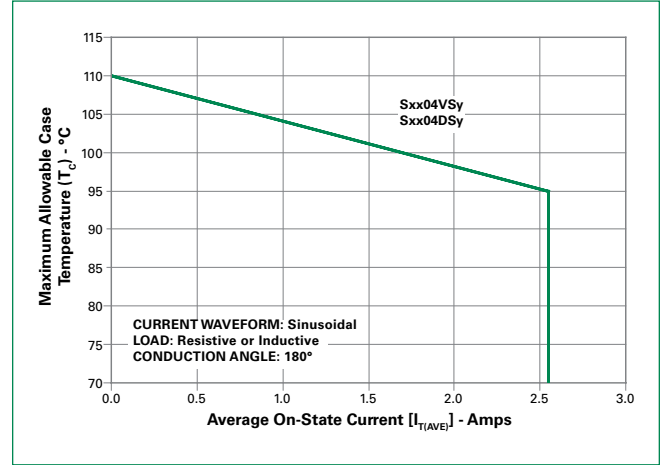


Note: xx or z = voltage, y = sensitivity

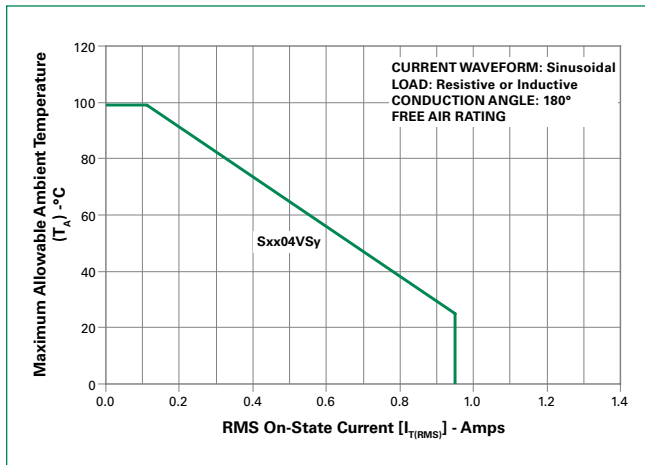
**Figure 7: Maximum Allowable Case Temperature vs. RMS On-State Current**



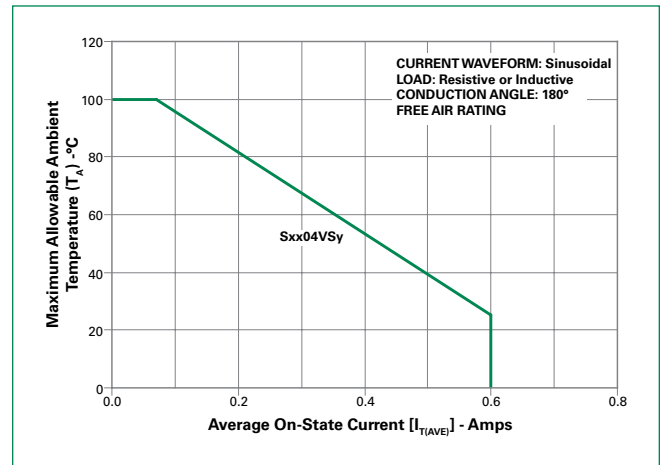
**Figure 8: Maximum Allowable Case Temperature vs. Average On-State Current**



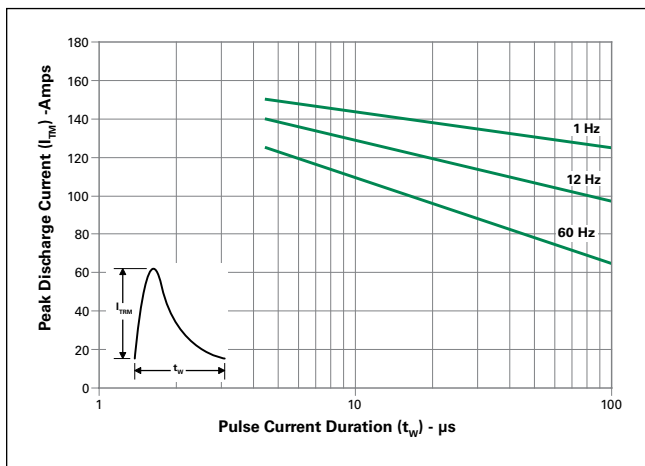
**Figure 9: Maximum Allowable Ambient Temperature vs. RMS On-State Current**



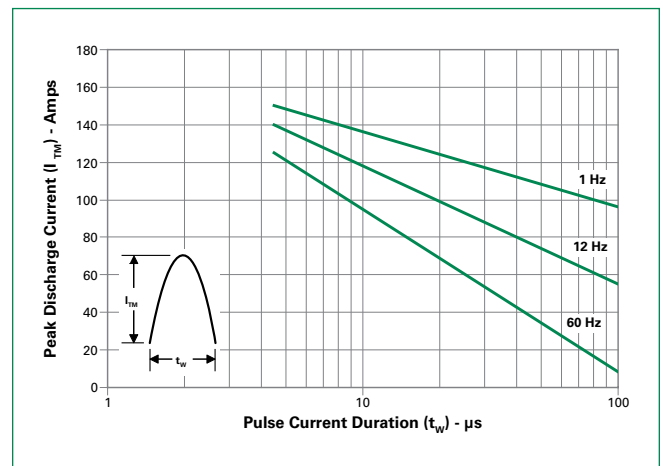
**Figure 10: Maximum Allowable Ambient Temperature vs. Average On-State Current**



**Figure 11: Peak Repetitive Capacitor Discharge Current**

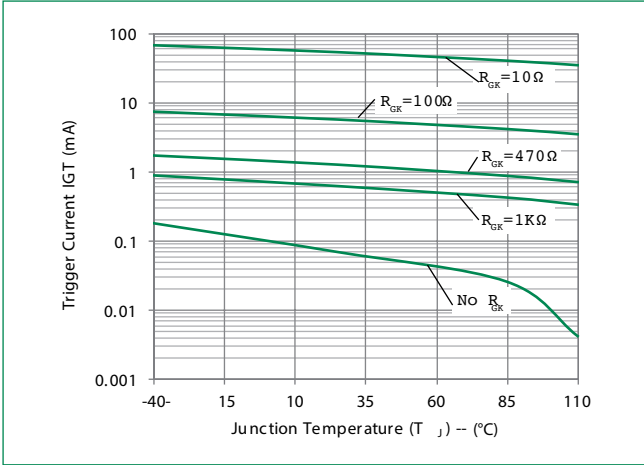


**Figure 12: Peak Repetitive Sinusoidal Pulse Current**

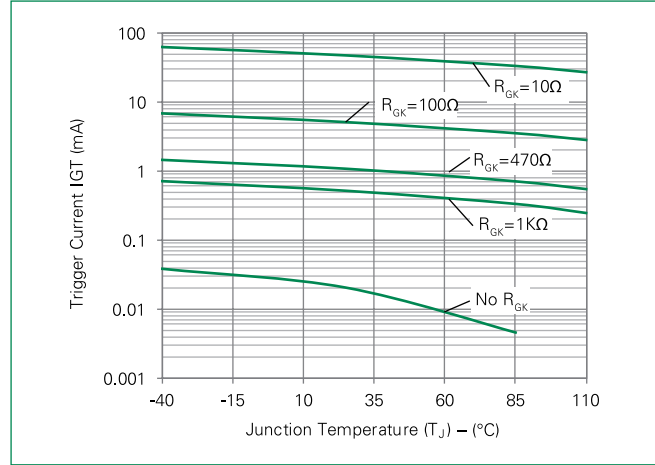


Note: xx = voltage, y = sensitivity

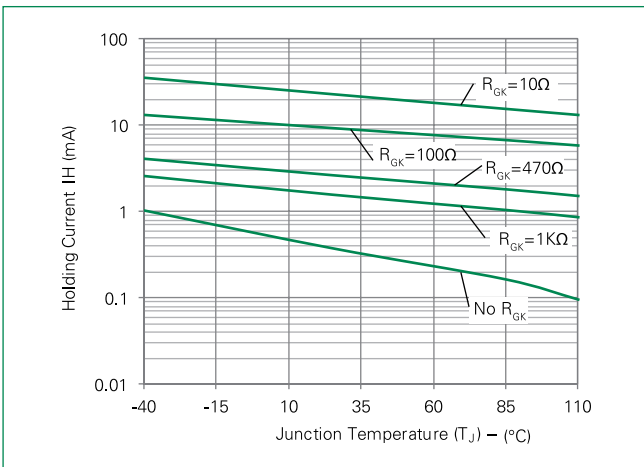
**Figure 13-1: Typical DC Gate Trigger Current with  $R_{GK}$  vs. Junction Temperature for S6004xS2**



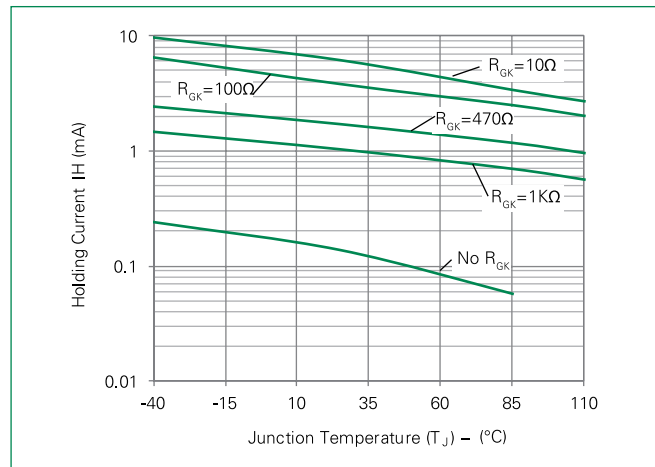
**Figure 13-2: Typical DC Gate Trigger Current with  $R_{GK}$  vs. Junction Temperature for S6004xS1**



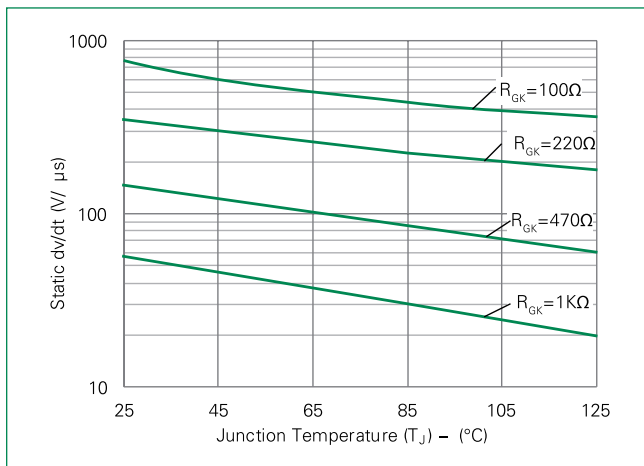
**Figure 14-1: Typical DC Holding Current with  $R_{GK}$  vs. Junction Temperature for S6004xS2**



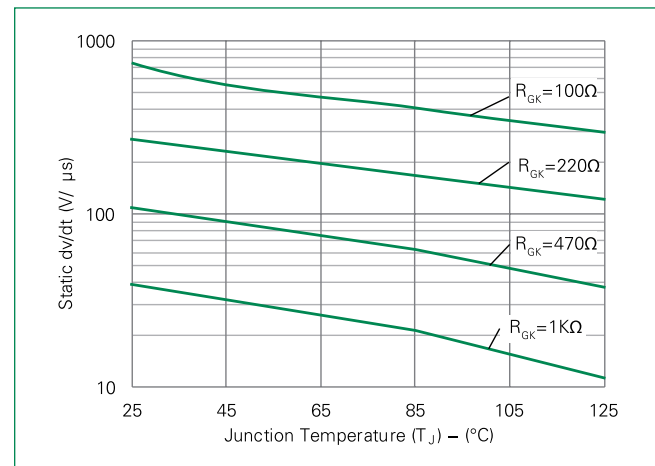
**Figure 14-2 Typical DC Holding Current with  $R_{GK}$  vs. Junction Temperature for S6004xS1**



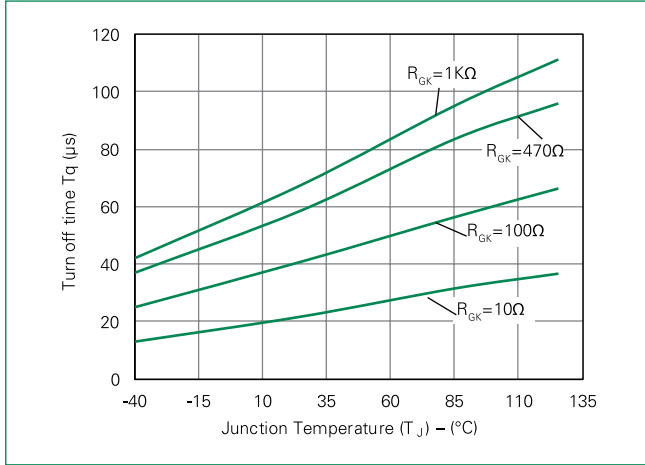
**Figure 15-1: Typical Static dv/dt with  $R_{GK}$  vs. Junction Temperature for S6004xS2**



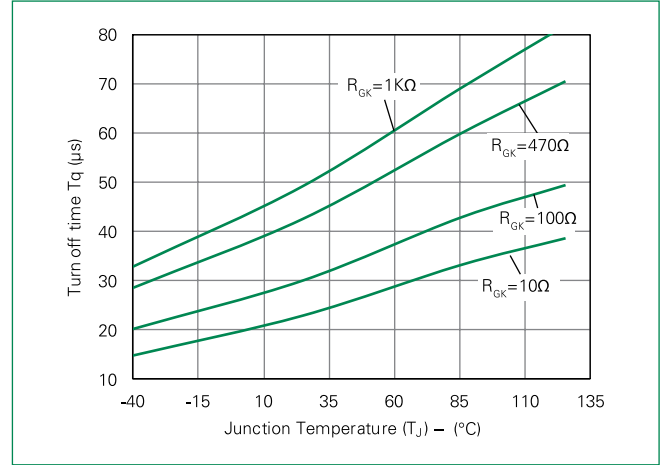
**Figure 15-2 Typical Static dv/dt with  $R_{GK}$  vs. Junction Temperature for S6004xS1**



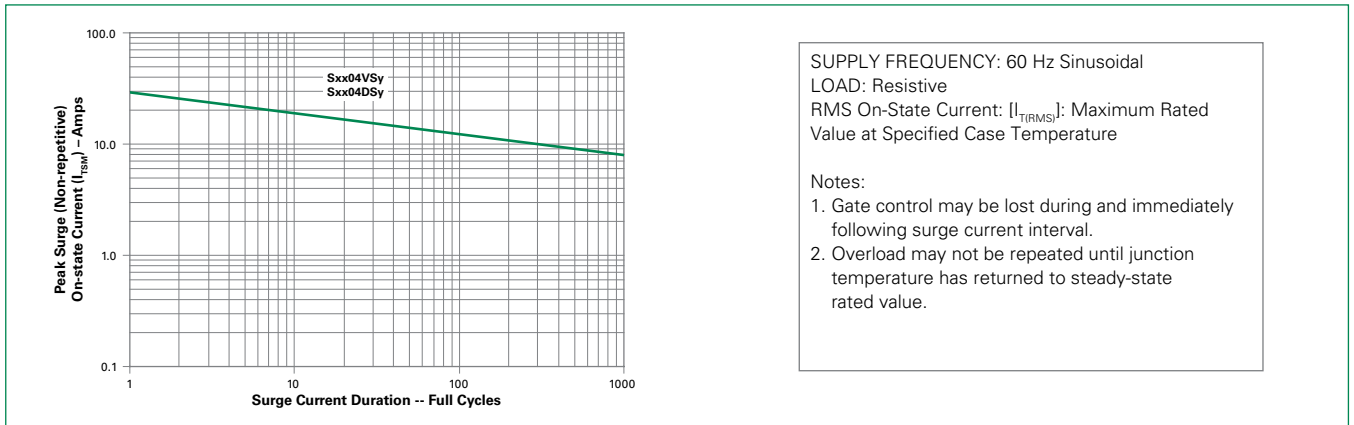
**Figure 16-1: Typical turn off time with  $R_{GK}$  vs. Junction Temperature for S6004xS2**



**Figure 16-2: Typical turn off time with  $R_{GK}$  vs. Junction Temperature for S6004xS1**

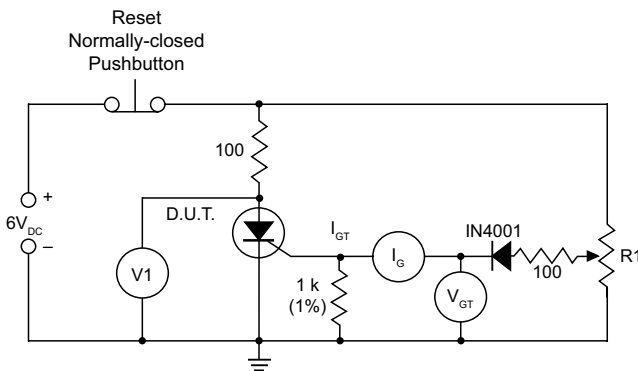


**Figure 17: Surge Peak On-State Current vs. Number of Cycles**



Note: xx or z - voltage, y = sensitivity

**Figure 18: Simple Test Circuit for Gate Trigger Voltage and Current**



Note: V1 — 0 V to 10 V dc meter  
 $V_{GT}$  — 0 V to 1 V dc meter  
 $I_G$  — 0 mA to 1 mA dc milliammeter  
 R1 — 1 k potentiometer

To measure gate trigger voltage and current, raise gate voltage ( $V_{GT}$ ) until meter reading V1 drops from 6 V to 1 V. Gate trigger voltage is the reading on  $V_{GT}$  just prior to V1 dropping. Gate trigger current  $I_{GT}$  can be computed from the relationship

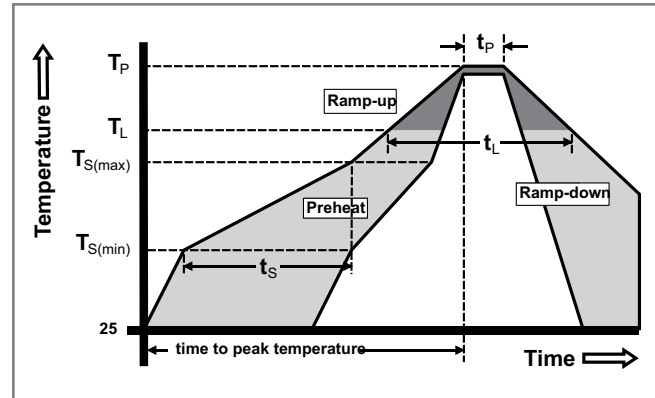
$$I_{GT} = I_G \cdot \frac{V_{GT}}{1000} \text{ Amps}$$

where  $I_G$  is reading (in amperes) on meter just prior to V1 dropping

Note:  $I_{GT}$  may turn out to be a negative quantity (trigger current flows out from gate lead). If negative current occurs,  $I_{GT}$  value is not a valid reading. Remove 1 k resistor and use  $I_G$  as the more correct  $I_{GT}$  value. This will occur on 12  $\mu$ A gate products.

### Soldering Parameters

Reflow Condition		Pb – Free assembly
Pre Heat	- Temperature Min ( $T_{s(min)}$ )	150°C
	- Temperature Max ( $T_{s(max)}$ )	200°C
	- Time (min to max) ( $t_s$ )	60 – 180 secs
Average ramp up rate (Liquidus Temp) ( $T_L$ ) to peak		5°C/second max
$T_{s(max)}$ to $T_L$ - Ramp-up Rate		5°C/second max
Reflow	- Temperature ( $T_L$ ) (Liquidus)	217°C
	- Temperature ( $t_l$ )	60 – 150 seconds
Peak Temperature ( $T_p$ )		260 <sup>+0/-5</sup> °C
Time within 5°C of actual peak Temperature ( $t_p$ )		20 – 40 seconds
Ramp-down Rate		5°C/second max
Time 25°C to peak Temperature ( $T_p$ )		8 minutes Max.
Do not exceed		280°C



### Physical Specifications

<b>Terminal Finish</b>	100% Matte Tin-plated
<b>Body Material</b>	UL recognized epoxy meeting flammability rating 94V-0
<b>Lead Material</b>	Copper Alloy

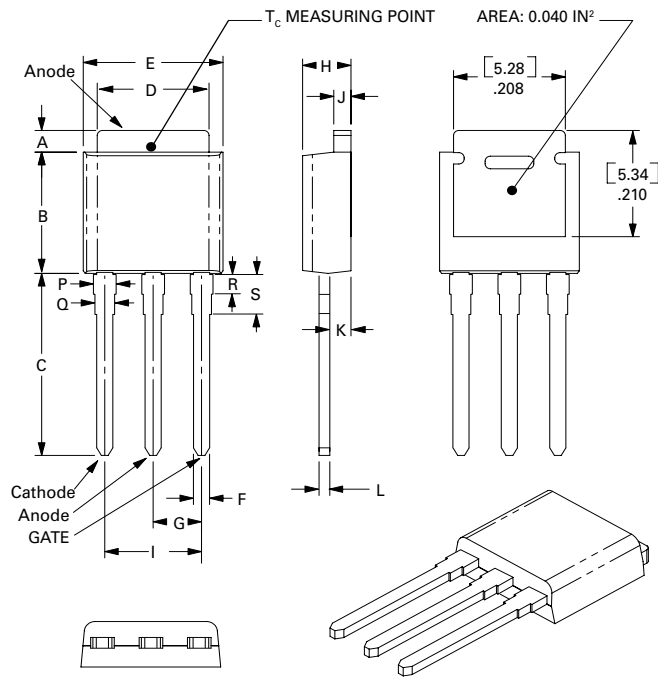
### Design Considerations

Careful selection of the correct component for the application's operating parameters and environment will go a long way toward extending the operating life of the Thyristor. Good design practice should limit the maximum continuous current through the main terminals to 75% of the component rating. Other ways to ensure long life for a power discrete semiconductor are proper heat sinking and selection of voltage ratings for worst case conditions. Overheating, overvoltage (including  $dv/dt$ ), and surge currents are the main killers of semiconductors. Correct mounting, soldering, and forming of the leads also help protect against component damage.

### Environmental Specifications

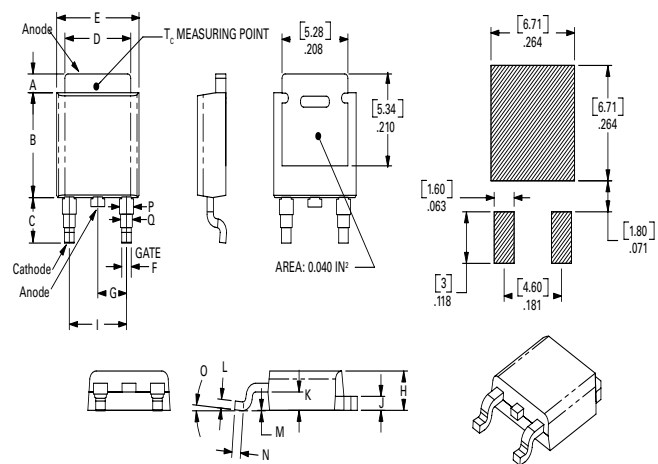
Test	Specifications and Conditions
<b>AC Blocking</b>	MIL-STD-750, M-1040, Cond A Applied Peak AC voltage @ 125°C for 1008 hours , $R_{GK} = 1\text{ kohms}$
<b>Temperature Cycling</b>	MIL-STD-750, M-1051, 100 cycles; -40°C to +150°C; 15-min dwell-time
<b>Temperature/Humidity</b>	EIA / JEDEC, JESD22-A101 1008 hours; 320V - DC; 85°C; 85% rel humidity
<b>High Temp Storage</b>	MIL-STD-750, M-1031, 1008 hours; 150°C
<b>Low-Temp Storage</b>	1008 hours; -40°C
<b>Resistance to Solder Heat</b>	MIL-STD-750 Method 2031
<b>Solderability</b>	ANSI/J-STD-002, category 3, Test A
<b>Lead Bend</b>	MIL-STD-750, M-2036 Cond E

### Dimensions — TO-251AA (V/I-Package) — V/I-PAK Through Hole



Dimension	Inches			Millimeters		
	Min	Typ	Max	Min	Typ	Max
A	0.037	0.040	0.043	0.94	1.01	1.09
B	0.235	0.242	0.245	5.97	6.15	6.22
C	0.350	0.361	0.375	8.89	9.18	9.53
D	0.205	0.208	0.213	5.21	5.29	5.41
E	0.255	0.262	0.265	6.48	6.66	6.73
F	0.027	0.031	0.033	0.69	0.80	0.84
G	0.087	0.090	0.093	2.21	2.28	2.36
H	0.085	0.092	0.095	2.16	2.34	2.41
I	0.176	0.180	0.184	4.47	4.57	4.67
J	0.018	0.020	0.023	0.46	0.51	0.58
K	0.035	0.037	0.039	0.90	0.95	1.00
L	0.018	0.020	0.023	0.46	0.52	0.58
P	0.042	0.047	0.052	1.06	1.20	1.32
Q	0.034	0.039	0.044	0.86	1.00	1.11
R	0.034	0.039	0.044	0.86	1.00	1.11
S	0.074	0.079	0.084	1.86	2.00	2.11

### Dimensions — TO-252AA (D-Package) — D-PAK Surface Mount



Dimension	Inches			Millimeters		
	Min	Typ	Max	Min	Typ	Max
A	0.037	0.040	0.043	0.94	1.01	1.09
B	0.235	0.243	0.245	5.97	6.16	6.22
C	0.106	0.108	0.113	2.69	2.74	2.87
D	0.205	0.208	0.213	5.21	5.29	5.41
E	0.255	0.262	0.265	6.48	6.65	6.73
F	0.027	0.031	0.033	0.69	0.80	0.84
G	0.087	0.090	0.093	2.21	2.28	2.36
H	0.085	0.092	0.095	2.16	2.33	2.41
I	0.176	0.179	0.184	4.47	4.55	4.67
J	0.018	0.020	0.023	0.46	0.51	0.58
K	0.035	0.037	0.039	0.90	0.95	1.00
L	0.018	0.020	0.023	0.46	0.51	0.58
M	0.000	0.000	0.004	0.00	0.00	0.10
N	0.021	0.026	0.027	0.53	0.67	0.69
O	0°	0°	5°	0°	0°	5°
P	0.042	0.047	0.052	1.06	1.20	1.32
Q	0.034	0.039	0.044	0.86	1.00	1.11



### Product Selector

Part Number	Voltage				Gate Sensitivity	Type	Package
	400V	600V	800V	1000V			
Sxx04DS1	X	X			50 $\mu$ A	Sensitive SCR	TO-252
Sxx04DS2	X	X			200 $\mu$ A	Sensitive SCR	TO-252
Sxx04VS1	X	X			50 $\mu$ A	Sensitive SCR	TO-251
Sxx04VS2	X	X			200 $\mu$ A	Sensitive SCR	TO-251

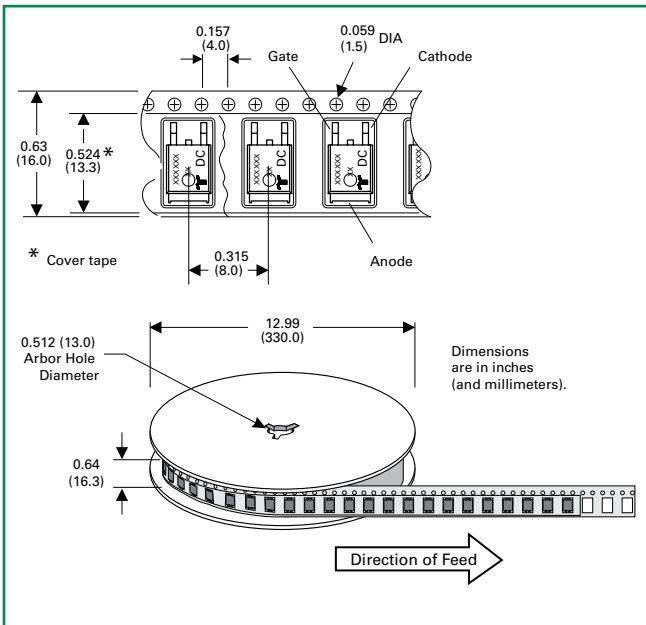
Note: xx = Voltage

### Packing Options

Part Number	Marking	Weight	Packing Mode	Base Quantity
Sxx04DSyTP	Sxx04DSy	0.3g	Tube	750 (75 per tube)
Sxx04DSyRP	Sxx04DSy	0.3g	Embossed Carrier	2500
Sxx04VSyTP	Sxx04VSy	0.4g	Tube	750 (75 per tube)

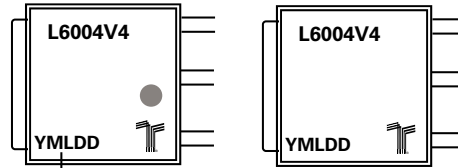
Note: xx = voltage, y = sensitivity

### TO-252 Embossed Carrier Reel Pack (RP) Specs



### Part Marking System

TO-251AA- (V Package)  
TO-252AA- (D Package)



Date Code Marking  
Y: Year Code  
M: Month Code  
L: Location Code  
DD: Calendar Code

### Part Numbering System

