

CD54/74HC7046A
CD54/74HCT7046A

File Number 1920

HARRIS SEMICONDUCTOR

27E D ■ 4302271 0018164 4 ■ HAS

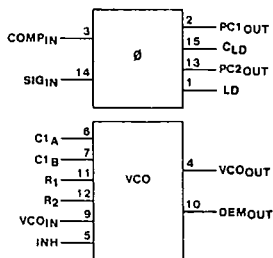

92CS-41204

FUNCTIONAL DIAGRAM

**Phase-Locked Loop with VCO
And Lock Detector**

Type Features:

- Center frequency of 18 MHz (typ.) at $V_{CC} = 5\text{ V}$
- Choice of two phase comparators: Exclusive-OR, Edge-triggered JK flip-flop
- Excellent VCO frequency linearity
- VCO-inhibit control for ON/OFF keying and for low standby power consumption
- Minimal frequency drift
- Zero voltage offset due to op-amp buffer
- Operating power-supply voltage range: VCO section 3 V to 6 V; Digital section 2 V to 6 V

The RCA-CD54/74HC7046A and CD54/74HCT7046A high-speed silicon-gate CMOS devices, specified in compliance with JEDEC Standard No. 7A, are phase-locked-loop (PLL) circuits that contain a linear voltage-controlled oscillator (VCO), two-phase comparators (PC1, PC2), and a lock detector. A signal input and a comparator input are common to each comparator. The lock detector gives a HIGH level at pin 1 (LD) when the PLL is locked. The lock detector capacitor must be connected between pin 15 (C_{LD}) and pin 8 (Gnd). For a frequency range of 100 kHz to 10 MHz, the lock detector capacitor should be 1000 pF to 10 pF, respectively.

The signal input can be directly coupled to large voltage signals, or indirectly coupled (with a series capacitor) to small voltage signals. A self-bias input circuit keeps small voltage signals within the linear region of the input amplifiers. With a passive low-pass filter, the 7046A forms a second-order loop PLL. The excellent VCO linearity is achieved by the use of linear op-amp techniques.

The CD54HC7046A and CD54HCT7046A are supplied in 16-lead ceramic dual-in-line packages (F suffix). The CD74HC7046A and CD74HCT7046A are supplied in 16-lead plastic dual-in-line packages (E suffix) and in 16-lead small-outline plastic dual-in-line packages (M suffix). Both types are also available in chip form (H suffix).

Applications:

- FM modulation and demodulation
- Frequency synthesis and multiplication
- Frequency discrimination
- Tone decoding
- Data synchronization and conditioning
- Voltage-to-frequency conversion
- Motor-speed control
- For additional information, refer to application note, ICAN-8823.

Family Features:

- Fanout (over temperature range): Standard outputs - 10 LSTTL loads; Bus driver outputs - 15 LSTTL loads
- Wide operating temperature range: CD74HC/HCT: -40 to +125°C
- Balanced propagation delay and transition times
- Significant power reduction compared to LSTTL logic ICs
- Alternate source: Philips/Signetics
- CD54HC/CD74HC types: 2 V to 6 V operation; High noise immunity: $N_{IL}=30\%$, $N_{IH}=30\%$ of V_{CC} ; @ $V_{CC}=5\text{ V}$
- CD54HCT/CD74HCT types: 4.5 V to 5.5 V operation; Direct LSTTL input logic compatibility: $V_{IL}=0.8\text{ V max.}$, $V_{IH}=2\text{ V min.}$; CMOS input compatibility: $I_{L1} \leq 1\ \mu\text{A}$ @ V_{OL} , V_{OH}

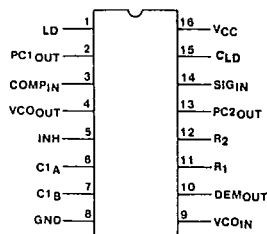

92CS-41205

TERMINAL ASSIGNMENT

HARRIS SEMICONDUCTOR 27E D 430227J 0018165 6 HAS

CD54/74HC7046A CD54/74HCT7046A

MAXIMUM RATINGS, Absolute-Maximum Values:

DC SUPPLY-VOLTAGE, (V _{cc}): (Voltages referenced to ground)	-0.5 to +7 V
DC INPUT DIODE CURRENT, I _{IK} (FOR V _i < -0.5 V OR V _i > V _{cc} +0.5 V)	±20 mA
DC OUTPUT DIODE CURRENT, I _{OK} (FOR V _o < -0.5 V OR V _o > V _{cc} +0.5 V)	±20 mA
DC DRAIN CURRENT, PER OUTPUT (I _o) (FOR -0.5 V < V _o < V _{cc} +0.5 V)	±25 mA
DC V _{cc} OR GROUND CURRENT (I _{cc})	±50 mA
POWER DISSIPATION PER PACKAGE (P _o):	
For T _A = -40 to +100°C (PACKAGE TYPE E)	500 mW
For T _A = +100 to +125°C (PACKAGE TYPE E)	Derate Linearly at 8 mW/°C to 300 mW
For T _A = -55 to +100°C (PACKAGE TYPE F,H)	500 mW
For T _A = +100 to +125°C (PACKAGE TYPE F,H)	Derate Linearly at 8 mW/°C to 300 mW
For T _A = -40 to +70°C (PACKAGE TYPE M)	400 mW
For T _A = +70 to +125°C (PACKAGE TYPE M)	Derate Linearly at 6 mW/°C to 70 mW
OPERATING-TEMPERATURE RANGE (T _A):	
PACKAGE TYPE F,H	-55 to +125°C
PACKAGE TYPE E,M	-40 to +125°C
STORAGE TEMPERATURE (T _{stg})	-65 to +150°C
LEAD TEMPERATURE (DURING SOLDERING):	
At distance 1/16 ± 1/32 in. (1.59 ± 0.79 mm) from case for 10 s max.	+265°C
Unit inserted into a PC Board (min. thickness 1/16 in., 1.59 mm) with solder contacting lead tips only	+300°C

RECOMMENDED OPERATING CONDITIONS

For maximum reliability, nominal operating conditions should be selected so that operation is always within the following ranges:

CHARACTERISTIC	LIMITS		UNITS
	MIN.	MAX.	
Supply-Voltage Range (For T _A =Full Package-Temperature Range) V _{cc} *			
CD54/74HC Types	2	6	V
CD54/74HCT Types	4.5	5.5	
DC Input or Output Voltage, V _i , V _o	0	V _{cc}	V
Operating Temperature, T _A :			
CD74 Types	-40	+125	°C
CD54 Types	-55	+125	
Input Rise and Fall Times, t _r , t _f			
at 2 V	0	1000	ns
at 4.5 V	0	500	
at 6 V	0	400	

*Unless otherwise specified, all voltages are referenced to Ground.

PIN DESCRIPTION

Pin No.	Symbol	Name and Function
1	LD	Lock Detector output (active high)
2	PC1 _{OUT}	Phase Comparator 1 output
3	COMP _{IN}	Comparator input
4	VCO _{OUT}	VCO output
5	INH	Inhibit input
6	C1 _A	Capacitor C1 connection A
7	C1 _B	Capacitor C1 connection B
8	Gnd	Ground (0 V)

Pin No.	Symbol	Name and Function
9	VCO _{IN}	VCO Input
10	DEM _{OUT}	Demodulator output
11	R ₁	Resistor R1 connection
12	R ₂	Resistor R2 connection
13	PC2 _{OUT}	Phase Comparator 2 output
14	SIG _{IN}	Signal input
15	CLD	Lock Detector Capacitor input
16	V _{cc}	Positive Supply Voltage

CD54/74HC7046A
CD54/74HCT7046A

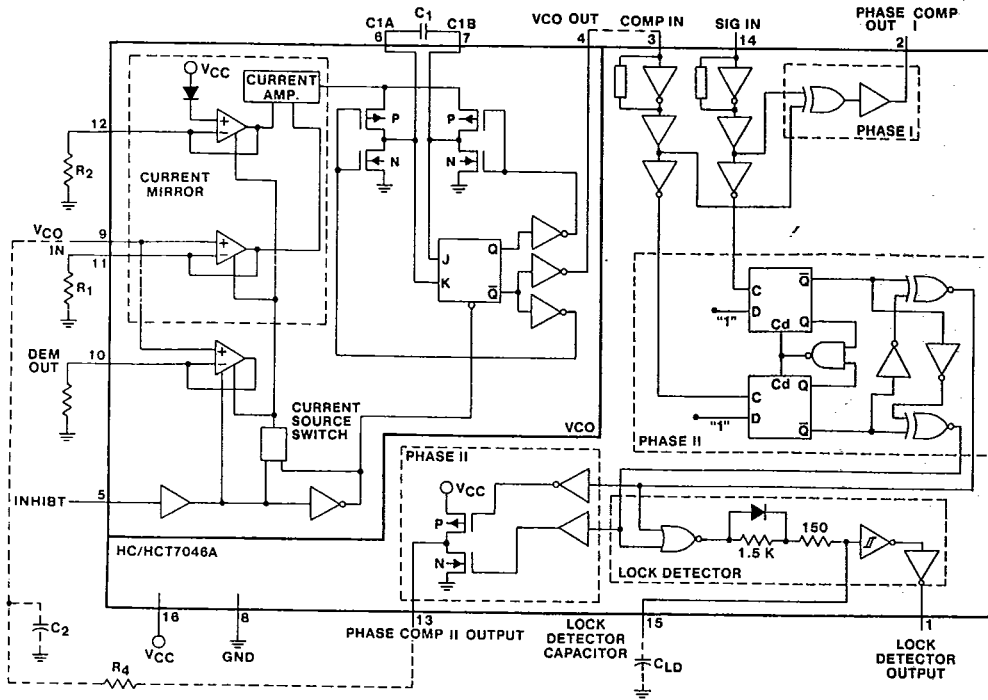

Fig. 1 - Logic diagram.

92CM-43257

GENERAL DESCRIPTION

VCO

The VCO requires one external capacitor C1 (between C1a and C1b) and one external resistor R1 (between R1 and Gnd) or two external resistors R1 and R2 (between R1 and Gnd, and R2 and Gnd). Resistor R1 and capacitor C1 determine the frequency range of the VCO. Resistor R2 enables the VCO to have a frequency offset if required. See logic diagram, Fig. 1.

The high input impedance of the VCO simplifies the design of low-pass filters by giving the designer a wide choice of resistor/capacitor ranges. In order not to load the low-pass filter, a demodulator output of the VCO input voltage is provided at pin 10 (DEM_{OUT}). In contrast to conventional techniques where the DEM_{OUT} voltage is one threshold voltage lower than the VCO input voltage, here the DEM_{OUT} voltage equals that of the VCO input. If DEM_{OUT} is used, a load resistor (R_s) should be connected from DEM_{OUT} to Gnd; if unused, DEM_{OUT} should be left open. The VCO output (VCO_{OUT}) can be connected directly to the comparator input (COMP_{IN}), or connected via a frequency-divider. The VCO output signal has a guaranteed duty factor of 50%. A LOW level at the inhibit input (INH) enables the VCO, while a HIGH level disables the VCO to minimize standby power consumption.

Phase Comparators

The signal input (SIG_{IN}) can be directly coupled to the self-biasing amplifier at pin 14, provided that the signal swing is between the standard HC family input logic levels. Capacitive coupling is required for signals with smaller swings.

Phase Comparator 1 (PC1)

This is an Exclusive-OR network. The signal and comparator input frequencies (f_i) must have a 50% duty factor to obtain the maximum locking range. The transfer characteristic of PC1, assuming ripple (f_r = 2f_i) is suppressed, is:

$V_{DEMOUT} = (V_{CC}/\pi) (\phi_{SIGIN} - \phi_{COMPIN})$ where V_{DEMOUT} is the demodulator output at pin 10; V_{DEMOUT} = V_{FC1OUT} (via low-pass filter).

The average output voltage from PC1, fed to the VCO input via the low-pass filter and seen at the demodulator output at pin 10 (V_{DEMOUT}), is the resultant of the phase differences of signals (SIG_{IN}) and the comparator input (COMP_{IN}) as shown in Fig. 2. The average of V_{DEM} is equal to 1/2 V_{CC} when there is no signal or noise at SIG_{IN}, and with this input the VCO oscillates at the center frequency (f₀). Typical waveforms for the PC1 loop locked at f₀ are shown in Fig. 3.

The frequency capture range (2f_c) is defined as the frequency range of input signals on which the PLL will lock if it was initially out-of-lock. The frequency lock range (2f_l) is defined as the frequency range of input signals on which the loop will stay locked if it was initially in lock. The capture range is smaller or equal to the lock range.

With PC1, the capture range depends on the low-pass filter characteristics and can be made as large as the lock range. This configuration retains lock behavior even with very noisy input signals. Typical of this type of phase comparator is that it can lock to input frequencies close to the harmonics of the VCO center frequency.

HARRIS SEMICONDUCTOR 27E D 430227J 00J8J66 8 HAS

**CD54/74HC7046A
CD54/74HCT7046A**

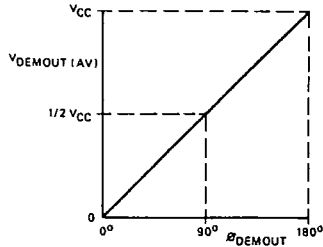

Fig. 2 - Phase comparator 1: average output voltage vs input phase difference:
 $V_{DEMOUT} = V_{PC1OUT} = (V_{CC}/\pi) (\phi_{SIGIN} - \phi_{COMPIN});$
 $\phi_{DEMOUT} = (\phi_{SIGIN} - \phi_{COMPIN}).$

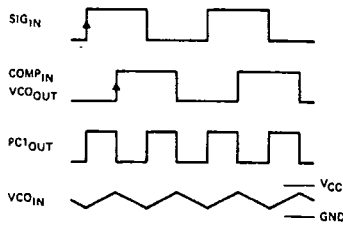

Fig. 3 - Typical waveforms for PLL using phase comparator 1, loop locked at f_0 .

Phase Comparator 2 (PC2)

This is a positive edge-triggered phase and frequency detector. When the PLL is using this comparator, the loop is controlled by positive signal transitions and the duty factors of SIG_{IN} and COMP_{IN} are not important. PC2 comprises two D-type flip-flops, control-gating and a 3-state output stage. The circuit functions as an up-down counter (Fig. 1) where SIG_{IN} causes an up-count and COMP_{IN} a down-count. The transfer function of PC2, assuming ripple ($f_r = f_i$) is suppressed, is:

$V_{DEMOUT} = (V_{CC}/4\pi) (\phi_{SIGIN} - \phi_{COMPIN})$ where V_{DEMOUT} is the demodulator output at pin 10; $V_{DEMOUT} = V_{PC2OUT}$ (via low-pass filter).

The average output voltage from PC2, fed to the VCO via the low-pass filter and seen at the demodulator output at pin 10 (V_{DEMOUT}), is the resultant of the phase differences of SIG_{IN} and COMP_{IN} as shown in Fig. 4. Typical waveforms for the PC2 loop locked at f_0 are shown in Fig. 5.

When the frequencies of SIG_{IN} and COMP_{IN} are equal but the phase of SIG_{IN} leads that of COMP_{IN}, the p-type output driver at PC2_{OUT} is held "ON" for a time corresponding to the phase difference (ϕ_{DEMOUT}). When the phase of SIG_{IN} lags that of COMP_{IN}, the n-type driver is held "ON".

When the frequency of SIG_{IN} is higher than that of COMP_{IN}, the p-type output driver is held "ON" for most of the input signal cycle time, and for the remainder of the cycle both n- and p-type drivers are "OFF" (3-state). If the SIG_{IN} frequency is lower than the COMP_{IN} frequency, then it is the n-type driver that is held "ON" for most of the cycle. Subsequently, the voltage at the capacitor (C2) of the low-pass filter connected to PC2_{OUT} varies until the signal and comparator inputs are equal in both phase and frequency. At this stable point the voltage on C2 remains constant as the PC2 output is in 3-state and the VCO input at pin 9 is a high impedance.

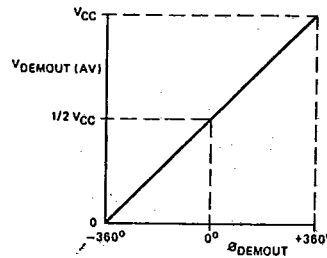

Fig. 4 - Phase comparator 2: average output voltage vs input phase difference:
 $V_{DEMOUT} = V_{PC2OUT} = (V_{CC}/4\pi) (\phi_{SIGIN} - \phi_{COMPIN});$
 $\phi_{DEMOUT} = (\phi_{SIGIN} - \phi_{COMPIN}).$

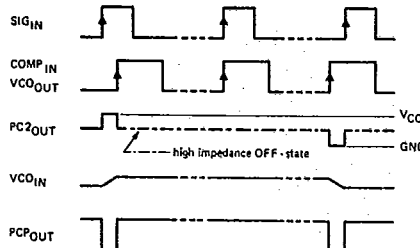

Fig. 5 - Typical waveforms for PLL using phase comparator 2, loop locked at f_0 .

Thus, for PC2, no phase difference exists between SIG_{IN} and COMP_{IN} over the full frequency range of the VCO. Moreover, the power dissipation due to the low-pass filter is reduced because both p- and n-type drivers are "OFF" for most of the signal input cycle. It should be noted that the PLL lock range for this type of phase comparator is equal to the capture range and is independent of the low-pass filter. With no signal present at SIG_{IN}, the VCO adjusts, via PC2, to its lowest frequency.

Lock Detector Theory of Operation

Detection of a locked condition is accomplished by a NOR gate and an envelope detector as shown in Fig. 6. When the PLL is in Lock, the output of the NOR gate is High and the lock detector output (Pin 1) is at a constant high level. As the loop tracks the signal on Pin 14 (signal In), the NOR gate outputs pulses whose widths represent the phase differences between the VCO and the input signal. The time between pulses will be approximately equal to the time constant of the VCO center frequency. During the rise time of the pulse, the diode across the 1.5-kΩ resistor is forward biased and the time constant in the path that charges the lock detector capacitor is

$T = (150 \Omega \times C_{LD}).$

During the fall time of the pulse the capacitor discharges through the 1.5 kΩ and the 150-Ω resistors and the channel resistance of the n-device of the NOR gate to ground

$(T = (1.5 \text{ k}\Omega + 150 \Omega + R_{n\text{-channel}}) \times C_{LD}).$

The waveform present at the capacitor resembles a sawtooth as shown in Fig. 7. The lock detector capacitor value is determined by the VCO center frequency. The typical range of capacitor for a frequency of 10 MHz is about 10 pF and for a frequency of 100 kHz is about 1000 pF. The chart in Fig. 8 can be used to select the proper lock detector capacitor value. As long as the loop remains locked and tracking, the

CD54/74HC7046A CD54/74HCT7046A

HARRIS SEMICOND SECTOR 27E D 4302271 0018168 1 HAS

level of the sawtooth will not go below the switching threshold of the Schmitt-trigger inverter. If the loop breaks lock, the width of the error pulse will be wide enough to allow the sawtooth waveform to go below threshold and a level change at the output of the Schmitt trigger will indicate a loss of lock, as shown in Fig. 9. The lock detector capacitor also acts to filter out small glitches that can occur when the loop is either seeking or losing lock.

Note: When using phase comparator 1, the detector will only indicate a lock condition on the fundamental frequency and not on the harmonics, which PC1 will also lock on. If a detection of lock is needed over the harmonic locking range of PC1, then the lock detector output must be OR-ed with the output of PC1.

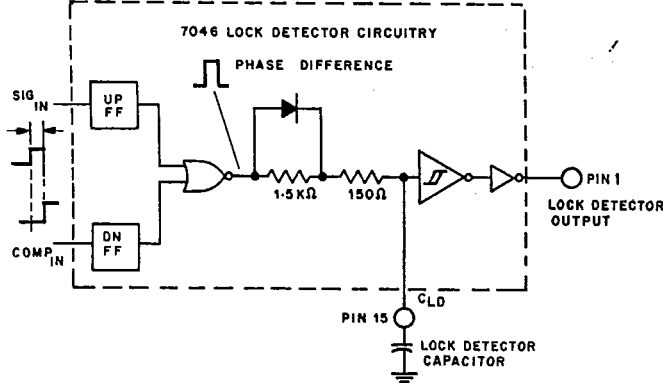

Fig. 6 - CD54/74HC/HCT7046A lock detector circuit.

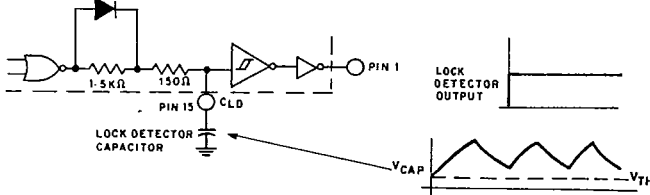

Fig. 7 - Waveform present at lock detector capacitor when in lock.

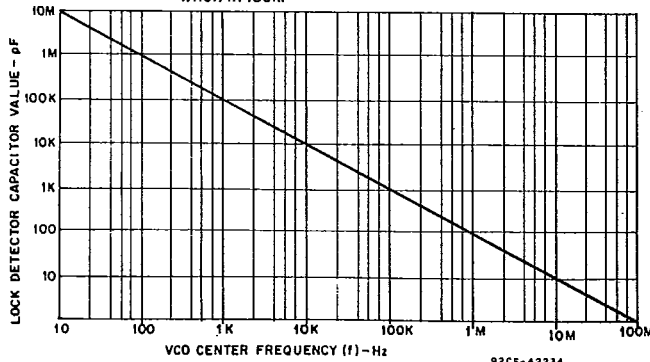

Fig. 8 - Lock detector capacitor selection chart.

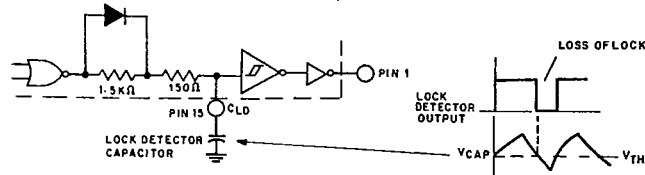

Fig. 9 - Waveform present at lock detector capacitor when unlocked.

CD54/74HC7046A
CD54/74HCT7046A

STATIC ELECTRICAL CHARACTERISTICS

CHARACTERISTIC	TEST CONDITIONS			74HC/54HC			74HC			54HC -55/ +125°C			TEST CONDITIONS			74HCT/54HCT			74HCT			54HCT -55/ +125°C			UNITS
	V _I V	I _O mA	V _{CC} V	+25°C			-40/ +85°C			74HC -40/ +125°C			V _I V	V _{CC} V	+25°C			-40/ +85°C			74HCT -40/ +125°C				
				Min	Typ	Max	Min	Max	Min	Max	Min	Max			Min	Typ	Max	Min	Max	Min	Max				
VCO SECTION																									
INH High-Level Input Voltage V _{IH}				3	2.1	—	—	2.1	—	2.1	—	—	—	4.5	to	2	—	—	2	—	2	—	—	V	
				4.5	3.15	—	—	3.15	—	3.15	—	—	—	5.5											
				6	4.2	—	—	4.2	—	4.2	—	—	—												
INH Low-Level Input Voltage V _{IL}				3	—	—	0.9	—	0.9	—	0.9	—	—	4.5	to	—	—	0.8	—	0.8	—	0.8	—	0.8	V
				4.5	—	—	1.35	—	1.35	—	1.35	—	—	5.5											
				6	—	—	1.8	—	1.8	—	1.8	—	—												
VCO _{out} High-Level Output Voltage V _{OH} CMOS Loads	V _{IL}	-0.02		3	2.9	—	—	2.9	—	2.9	—	—	V _{IL}	4.5	4.4	—	—	4.4	—	4.4	—	4.4	—	—	V
	or			4.5	4.4	—	—	4.4	—	4.4	—	—													
	V _{IH}			6	5.9	—	—	5.9	—	5.9	—	—													
TTL Loads	V _{IL}												V _{IL}	4.5	3.98	—	—	3.84	—	3.7	—	—	—	V	
	or	-4	4.5	3.98	—	—	3.84	—	3.7	—	—														
	V _{IH}	-5.2	6	5.48	—	—	5.34	—	5.2	—	—														
VCO _{out} Low-Level Output Voltage V _{OL} CMOS Loads	V _{IL}	0.02		2	—	—	0.1	—	0.1	—	0.1	—	V _{IL}	4.5	—	—	0.1	—	0.1	—	0.1	—	0.1	—	V
	or			4.5	—	—	0.1	—	0.1	—	0.1	—													
	V _{IH}			6	—	—	0.1	—	0.1	—	0.1	—													
TTL Loads	V _{IL}												V _{IL}	4.5	—	—	0.26	—	0.33	—	0.4	—	—	V	
	or	4	4.5	—	—	0.26	—	0.33	—	0.4	—														
	V _{IH}	5.2	6	—	—	0.26	—	0.33	—	0.4	—														
C1A, C1B Low-Level Output Voltage (Test purposes only) V _{OL}	V _{IL}												V _{IL}	4.5	—	—	0.40	—	0.47	—	0.54	—	—	V	
	or	4	4.5	—	—	0.40	—	0.47	—	0.54	—														
	V _{IH}	5.2	6	—	—	0.40	—	0.47	—	0.54	—														
INH VCO _{in} Input Leakage Current I _I	V _{CC}			6	—	—	±0.1	—	±1	—	±1	—	Any Voltage Between V _{CC} and Gnd	5.5	—	—	±0.1	—	±1	—	±1	—	—	μA	
	Gnd																								
R1 Range See Note 1				3	—	—	—	—	—	—	—	—		4.5	3	—	—	—	—	—	—	—	—	kΩ	
				4.5	3	—	—	—	—	—	—	—													
				6	—	—	—	—	—	—	—	—													
R2 Range See Note 1				3	—	—	—	—	—	—	—	—		4.5	3	—	—	—	—	—	—	—	—	kΩ	
				4.5	3	—	—	—	—	—	—	—													
				6	—	—	—	—	—	—	—	—													
C1 Capacitance Range				3	—	—	No L I M I T	—	—	—	—	—		4.5	40	—	No L I M I T	—	—	—	—	—	—	pF	
				4.5	40	—	—	—	—	—	—	—													
				6	—	—	—	—	—	—	—	—													
VCO _{in} Operating Voltage Range	Over the range specified for R1 for Linearity See Figs. 10 & 36-39 See Note 2			3	0.9	—	1.9	—	—	—	—	—		4.5	0.9	—	3.2	—	—	—	—	—	—	V	
				4.5	0.9	—	3.2	—	—	—	—	—													
				6	0.9	—	4.6	—	—	—	—	—													

NOTES: 1. The value for R1 & R2 in parallel should exceed 2.7 kΩ; R1 & R2 values above 300 kΩ may contribute to frequency shift due to leakage currents.
2. The maximum operating voltage can be as high as V_{CC} - 0.9 V; however, this may result in an increased offset voltage.

HARRIS SEMICONDUCTOR 27E D 430227J 0018169 3 HAS

CD54/74HC7046A
CD54/74HCT7046A

STATIC ELECTRICAL CHARACTERISTICS

CHARACTERISTIC	TEST CONDITIONS			74HC/54HC			74HC			54HC -55/ +125°C			TEST CONDITIONS		74HCT/54HCT			74HCT			54HCT -55/ +125°C			UNITS	
	V _I V	I _O mA	V _{CC} V	+25°C			-40/ +85°C			74HC -40/ +125°C			V _I V	V _{CC} V	+25°C			-40/ +85°C			74HCT -40/ +125°C				
				Min	Typ	Max	Min	Max	Min	Max	Min	Max			Min	Typ	Max	Min	Max	Min	Max	Min	Max		
PHASE COMPARATOR SECTION																									
SIG _{IN} , COMP _{IN} DC Coupled High-Level Input Voltage V _{IH}				2	1.5	—	—	1.5	—	1.5	—	—	—	4.5	to	3.15	—	—	3.15	—	3.15	—	—	—	V
				4.5	3.15	—	—	3.15	—	3.15	—														
				6	4.2	—	—	4.2	—	4.2	—														
SIG _{IN} , COMP _{IN} DC Coupled Low-Level Input Voltage V _{IL}				2	—	—	0.5	—	0.5	—	0.5	—	4.5	to	—	—	1.35	—	1.35	—	1.35	—	—	V	
				4.5	—	—	1.35	—	1.35	—	1.35														
				6	—	—	1.8	—	1.8	—	1.8														
LD, PC _{OUT} High-Level Output Voltage V _{OH}	V _{IL} or V _{IH}	-0.02		2	1.9	—	—	1.9	—	1.9	—	V _{IL} or V _{IH}	4.5	4.4	—	—	4.4	—	4.4	—	4.4	—	—	V	
				4.5	4.4	—	—	4.4	—	4.4	—														
				6	5.9	—	—	5.9	—	5.9	—														
TTL Loads	V _{IL} or V _{IH}	-4 -5.2		4.5	3.98	—	—	3.84	—	3.7	—	or V _{IH}	4.5	3.98	—	—	3.84	—	3.7	—	—	—	—	V	
				6	5.48	—	—	5.34	—	5.2	—														
				4	4.5	—	—	0.26	—	0.33	—														0.4
LD, PC _{OUT} Low-Level Output Voltage V _{OL}	V _{IL} or V _{IH}	0.02		2	—	—	0.1	—	0.1	—	0.1	V _{IL} or V _{IH}	4.5	—	—	0.1	—	0.1	—	0.1	—	—	—	V	
				4.5	—	—	0.1	—	0.1	—	0.1														
				6	—	—	0.1	—	0.1	—	0.1														
TTL Loads	V _{IL} or V _{IH}	4 5.2		4.5	—	—	0.26	—	0.33	—	0.4	or V _{IH}	4.5	—	—	0.26	—	0.33	—	0.4	—	—	—	V	
				6	—	—	0.26	—	0.33	—	0.4														
				4	4.5	—	—	0.26	—	0.33	—														0.4
SIG _{IN} , COMP _{IN} Input Leakage Current I _I	V _{CC} or Gnd			2	—	—	±3	—	±4	—	±5	Any Voltage Between V _{CC} and Gnd	5.5	—	—	±30	—	±38	—	±45	—	—	—	μA	
				3	—	—	±7	—	±9	—	±11														
				4.5	—	—	±18	—	±23	—	±29														
				6	—	—	±30	—	±38	—	±45														
PC _{2OUT} 3-State Off-State Current I _{OZ}	V _{IL} or V _{IH}			6	—	—	±0.5	—	±5	—	±10		5.5	—	—	±0.5	—	±5	—	±10	—	—	—	μA	
				3	—	800	—	—	—	—	—														
SIG _{IN} , COMP _{IN} Input Resistance See Fig. 10 R _I	V _I at Self-Bias Oper. Point. ΔV _I = 0.5 V See Fig. 10			3	—	250	—	—	—	—	—		4.5	—	250	—	—	—	—	—	—	—	—	kΩ	
				4.5	—	250	—	—	—	—	—														
				6	—	150	—	—	—	—	—														

HARRIS SEMICONDUCTOR 27E D 430227J 0010170 T HAS

HARRIS SEMICONDUCTOR 27E D 430227J 001817J HAS

CD54/74HC7046A
CD54/74HCT7046A

STATIC ELECTRICAL CHARACTERISTICS

CHARACTERISTIC	TEST CONDITIONS			74HC/54HC			74HC		54HC -55/ +125°C		TEST CONDITIONS		74HCT/54HCT			74HCT		54HCT -55/ +125°C		UNITS	
	V _I V	I _O mA	V _{CC} V	+25°C			-40/ +85°C		74HC -40/ +125°C		V _I V	V _{CC} V	+25°C			-40/ +85°C		74HCT -40/ +125°C			
				Min	Typ	Max	Min	Max	Min	Max			Min	Typ	Max	Min	Max	Min	Max		
DEMODULATOR SECTION																					
Resistor Range R _S	at R _S > 300 kΩ Leakage Current can influence V _{DEMOUT}			3	10	—	300						4.5	10	—	300				kΩ	
Offset Voltage VCO _{IN} , to V _{DEM} V _{OFF}	V _I = V _{VDDIN} = $\frac{V_{CC}}{2}$ Values taken over R _S range See Fig. 17			3	—	±30	—						4.5	—	±20	—				mV	
Dynamic Output Resistance at DEM _{OUT} R _O	V _{DEMOUT} = $\frac{V_{CC}}{2}$			3	—	25	—						4.5	—	25	—				Ω	
Quiescent Device Current I _{CC}	Pins 3, 5 & 14 at V _{CC} Pin 9 at Gnd. I _I , at Pins 3 & 14 to be excluded			6	—	—	8	—	80	—	160	V _{CC} or Gnd	5.5	—	—	8	—	80	—	160	μA
Additional Quiescent Device Current Per Input Pin: 1 unit load ΔI _{CC} *												V _{CC} -2.1 (Excluding Pin 5)	4.5 to 5.5	—	100	360	—	450	—	490	μA

*For dual-supply systems theoretical worst case (V_I = 2.4 V, V_{CC} = 5.5 V) specification is 1.8 mA.

HCT Input Loading Table

Input	Unit Loads*
INH	1

*Unit Load is ΔI_{CC} limit specified in Static Characteristics Chart, e.g., 360 μA max. @ 25°C.

CD54/74HC7046A
CD54/74HCT7046A

SWITCHING ELECTRICAL CHARACTERISTICS ($C_L = 50$ pF, Input $t_r = 6$ ns)

CHARACTERISTIC	TEST CONDITIONS		25°C				-40°C to +85°C				-55°C to +125°C (54) -40°C to +125°C (74)				UNITS	
	V _{CC}		HC		HCT		74HC		74HCT		HC		HCT			
			Min.	Max.	Min.	Max.	Min.	Max.	Min.	Max.	Min.	Max.	Min.	Max.		
PHASE COMPARATOR SECTION																
Propagation Delay, SIG _{IN} , COMP _{IN} to PC1 _{OUT}	t_{PLH}	2	—	200	—	—	—	250	—	—	—	—	300	—	—	ns
	t_{PHL}	4.5	—	40	—	45	—	50	—	56	—	60	—	68		
Output Transition Time	t_{RHL}	2	—	75	—	—	—	95	—	—	—	110	—	—		
	t_{LH}	4.5	—	15	—	15	—	19	—	19	—	22	—	22		
	t_{TLH}	6	—	13	—	—	—	16	—	—	—	19	—	—		
	t_{TLH}	6	—	13	—	—	—	16	—	—	—	19	—	—		
Output Enable Time, SIG _{IN} , COMP _{IN} to PC2 _{OUT}	t_{PZH}	2	—	280	—	—	—	350	—	—	—	420	—	—	ns	
	t_{PZH}	4.5	—	56	—	60	—	70	—	75	—	84	—	90		
	t_{PZL}	6	—	48	—	—	—	60	—	—	—	71	—	—		
Output Disable Time, SIG _{IN} , COMP _{IN} to PC2 _{OUT}	t_{PHZ}	2	—	325	—	—	—	405	—	—	—	490	—	—	ns	
	t_{PHZ}	4.5	—	65	—	70	—	81	—	86	—	98	—	105		
	t_{PLZ}	6	—	55	—	—	—	69	—	—	—	83	—	—		
AC Coupled Input Sensitivity (p-p) at SIG _{IN} or COMP _{IN}	V_i (p-p)	3	TYPICAL		11		11								mV	
		4.5			15		15									
		6			33		33									
VCO SECTION																
Frequency Stability with Temperature Change	$\frac{\Delta f}{\Delta T}$	$R_1 = 100$ k Ω	3	—	—	TYP.		TYP.						%/ $^{\circ}$ C		
		$R_2 = \infty$	4.5	—	—	0.11		0.11								
			6	—	—											
Max. Frequency	f_{max}	$C_1 = 50$ pF	3	—	—									MHz		
		$R_1 = 3.5$ k Ω	4.5	24	24											
		$R_2 = \infty$	6	—	—											
		$C_1 = 0$ pF	3	—	—									MHz		
		$R_1 = 9.1$ k Ω	4.5	38	38											
		$R_2 = \infty$	6	—	—											
Center Frequency	f_o	$C_1 = 40$ pF	3	—	—									MHz		
		$R_1 = 3$ k Ω	4.5	17	17											
		$R_2 = \infty$	6	—	—											
		$V_{COIN} = \frac{V_{CC}}{2}$														
Frequency Linearity, Δf_{vco}		$R_1 = 100$ k Ω	3	—	—									%		
		$R_2 = \infty$	4.5	0.4	0.4											
		$C_1 = 100$ pF	6	—	—											
Offset Frequency		$R_2 = 220$ k Ω	3	—	—									kHz		
		$C_1 = 1$ nF	4.5	400	400											
			6	—	—											
DEMODULATOR SECTION																
V_{OUT} vs. f_{IN}		$R_1 = 100$ k Ω	3	—	—									mV/kHz		
		$R_2 = \infty$	4.5	330	330											
		$C_1 = 100$ pF	6	—	—											
		$R_5 = 10$ k Ω														
		$R_3 = 100$ k Ω														
		$C_2 = 100$ pF														

HARRIS SEMICONDUCTOR 27E D 430227J 0010172 3 HAS

CD54/74HC7046A
CD54/74HCT7046A

Figure References for DC Characteristics

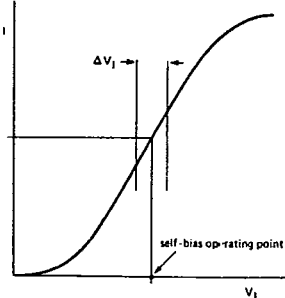

Fig. 10 - Typical input resistance curve at SIG_{IN}, COMP_{IN}.

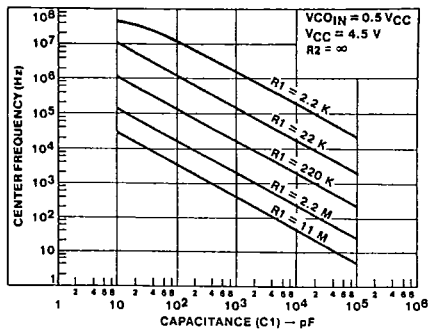

Fig. 11 - HC7046A typical center frequency vs. R1, C1.

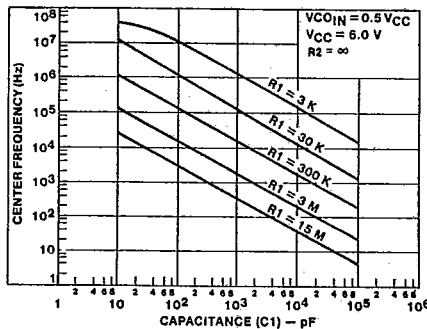

Fig. 12 - HC7046A typical center frequency vs. R1, C1.

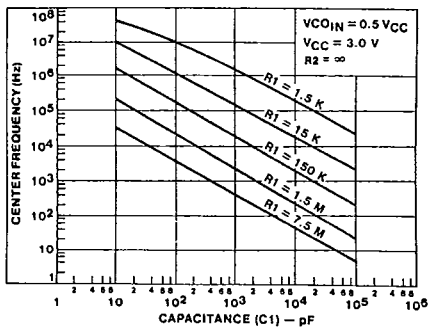

Fig. 13 - HC7046A typical center frequency vs. R1, C1.

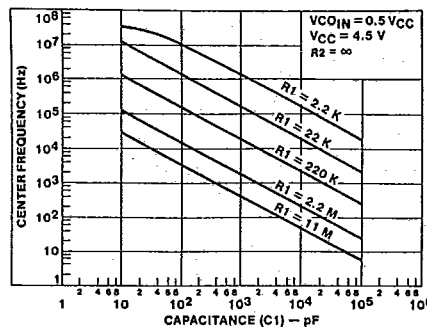

Fig. 14 - HCT7046A typical center frequency vs. R1, C1.

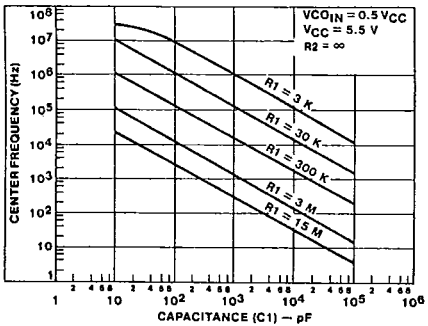

Fig. 15 - HCT7046A typical center frequency vs. R1, C1.

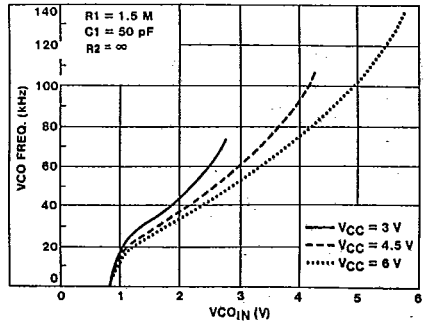
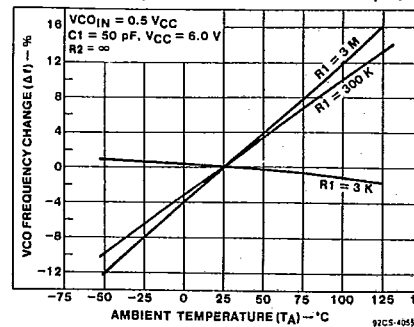
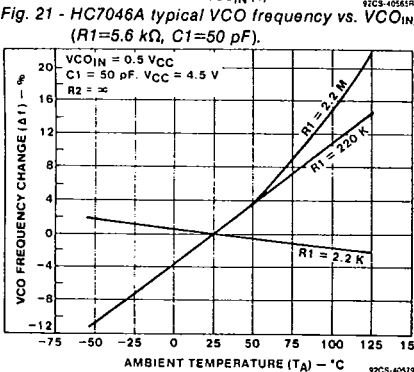
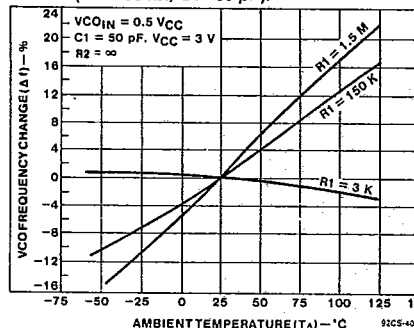
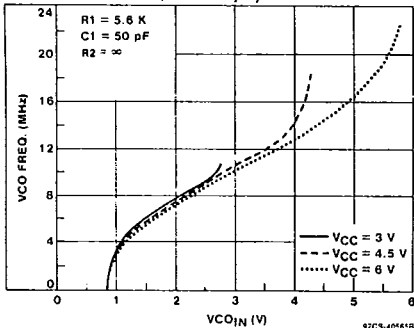
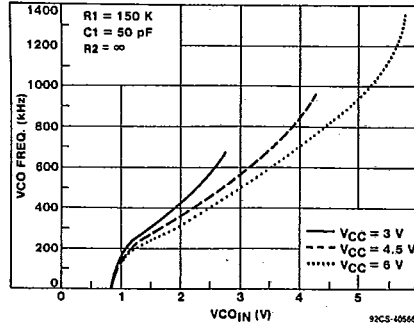
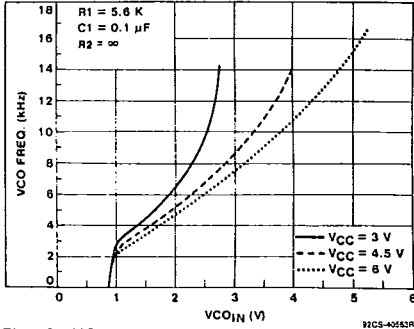
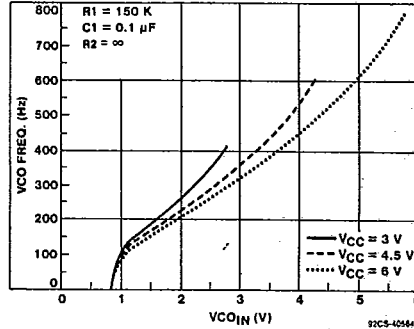
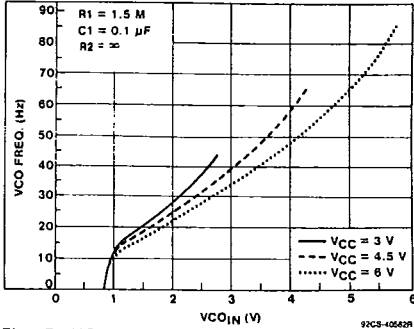

Fig. 16 - HC7046A typical VCO frequency vs. VCO_{IN}.

HARRIS SEMICONDUCTOR 27E D 430227J 0018173 5 HAS

CD54/74HC7046A
CD54/74HCT7046A

HARRIS SEMICONDUCTOR SECTOR 27E D 430227J 0018J74 7 HAS



HARRIS SEMICONDUCTOR 27E D 4302271 0018175 9 HAS

CD54/74HC7046A
CD54/74HCT7046A

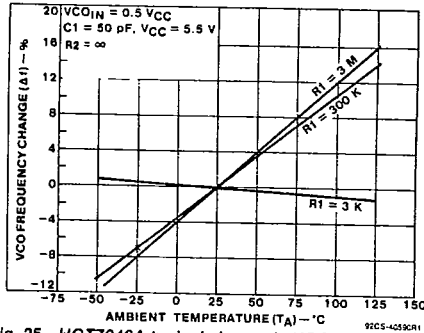

Fig. 25 - HCT7046A typical change in VCO frequency vs. ambient temperature as a function of R1.

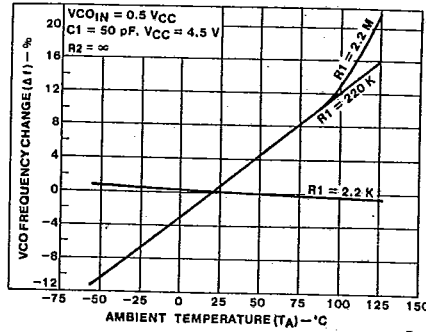

Fig. 26 - HC7046A typical change in VCO frequency vs. ambient temperature as a function of R1.

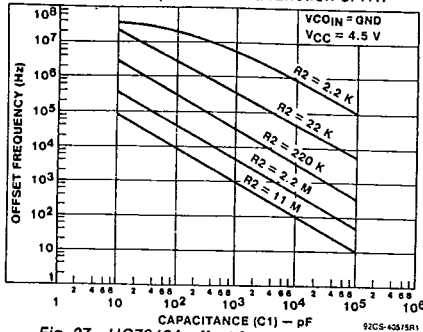

Fig. 27 - HC7046A offset frequency vs. R2, C1.

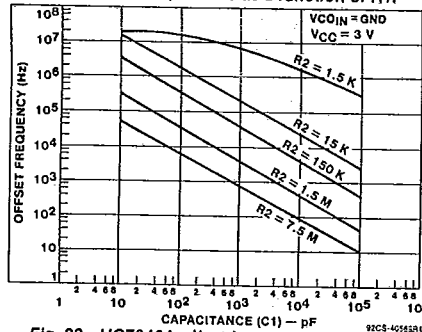

Fig. 28 - HC7046A offset frequency vs. R2, C1.

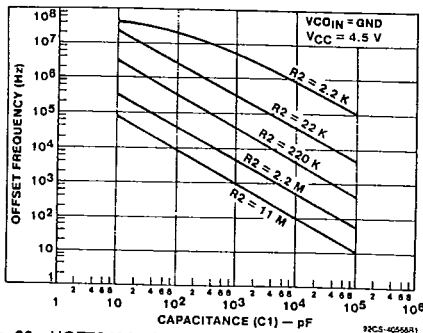

Fig. 29 - HCT7046A offset frequency vs. R2, C1 (VCC=4.5 V).

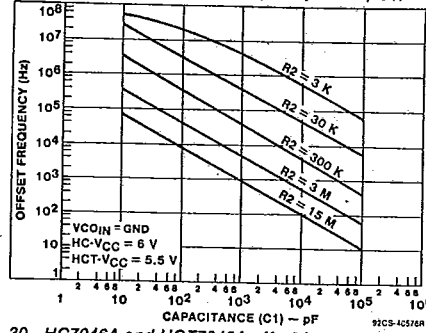

Fig. 30 - HC7046A and HCT7046A offset frequency vs. R2, C1.

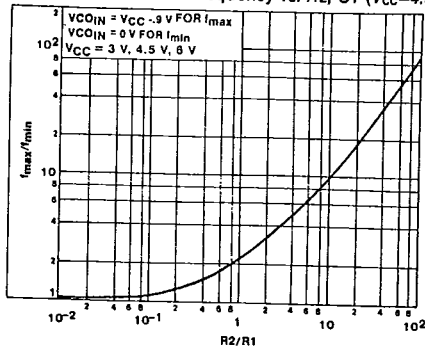

Fig. 31 - HC7046A f_{MAX}/f_{MIN} vs. R2/R1.

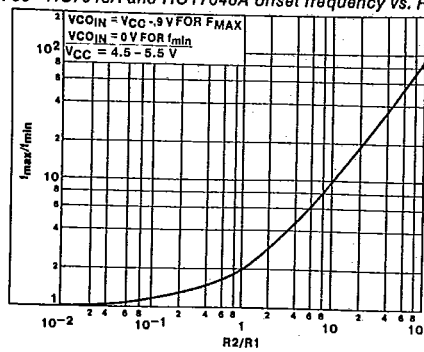

Fig. 32 - HCT7046A f_{MAX}/f_{MIN} vs. R2/R1.

CD54/74HC7046A
CD54/74HCT7046A

T-50-17

AC WAVEFORMS

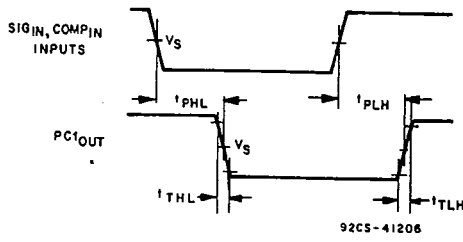

Fig. 33 - Waveforms showing Input (SIG_{IN}, COMP_{IN}) to output (PC1_{OUT}) propagation delays and the output transition times.

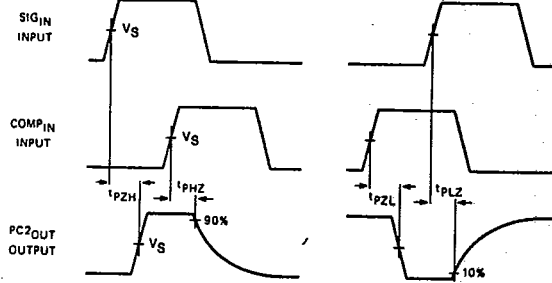
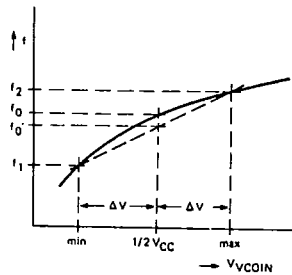

Fig. 34 - Waveforms showing the 3-state enable and disable times for PC2_{OUT}.

	HC	HCT
Input Level	V _{CC}	3 V
Switching Voltage, V _S	50% V _{CC}	1.3 V



$\Delta V = 0.5 \text{ V}$ over the V_{CC} range:

for VCO linearity

$$f_o = \frac{f_1 + f_2}{2}$$

$$\text{linearity} = \frac{f'_o - f_o}{f_o} \times 100\%$$

Fig. 35 - Definition of VCO frequency linearity.

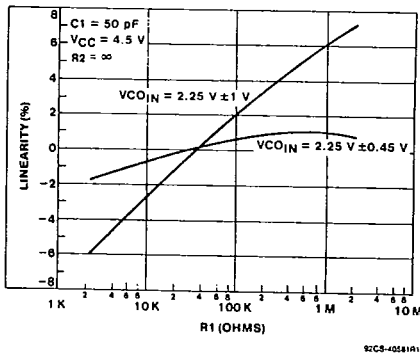

Fig. 36 - HC7046A VCO linearity vs. R1.

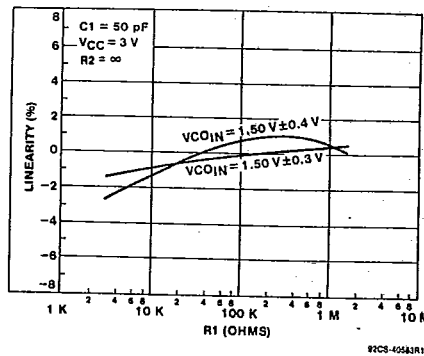

Fig. 37 - HC7046A VCO linearity vs. R1.

HARRIS SEMICONDUCTOR 27E D 430227J 0016176 0 HAS

CD54/74HC7046A
CD54/74HCT7046A

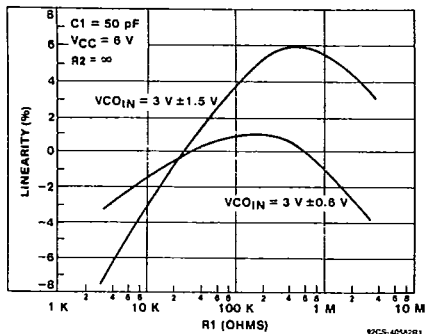

Fig. 38 - HC7046A VCO linearity vs. R1.

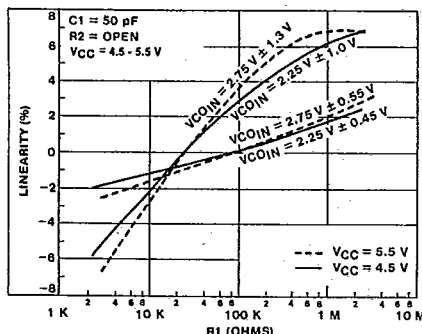

Fig. 39 - HCT7046A VCO linearity vs. R1.

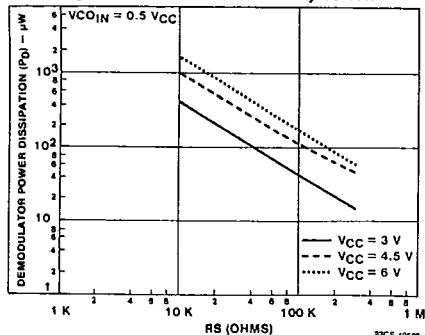

Fig. 40 - HC7046A demodulator power dissipation vs. RS (typ.).

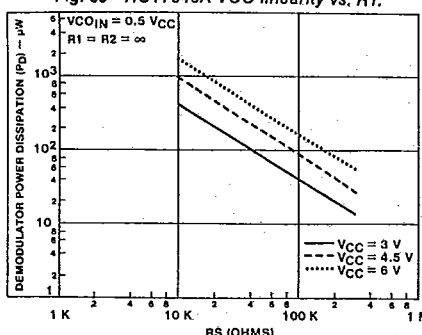

Fig. 41 - HCT7046A demodulator power dissipation vs. RS (typ.).

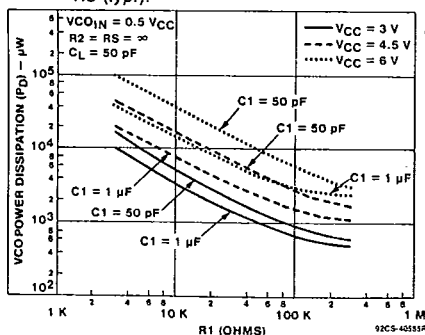

Fig. 42 - HC7046A VCO power dissipation vs. R1 (C1=50 pF, 1 μF).

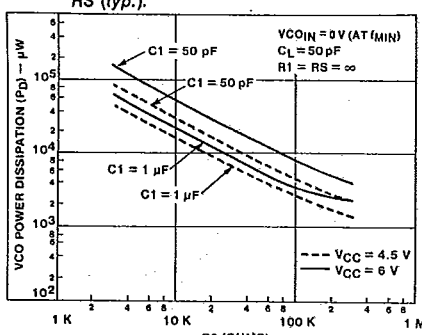

Fig. 43 - HCT7046A VCO power dissipation vs. R2 (C1=50 pF, 1 μF).

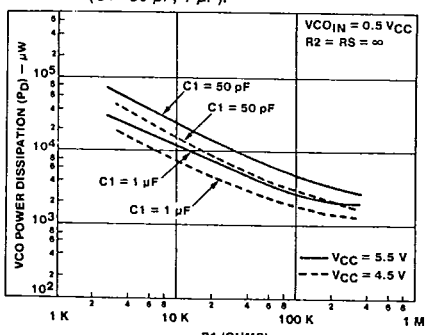

Fig. 44 - HCT7046A VCO power dissipation vs. R1 (C1=50 pF, 1 μF).

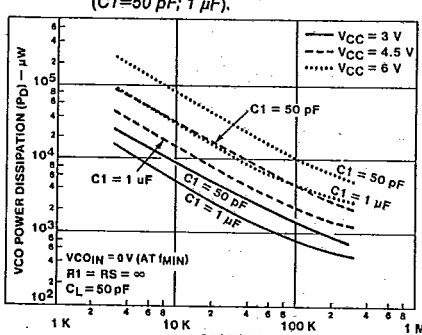

Fig. 45 - HC7046A VCO power dissipation vs. R2 (C1=50 pF, 1 μF).

CD54/74HC7046A
CD54/74HCT7046A

HC/HCT7046A C_{pd}

Chip Section	HC	HCT	Unit
Comparator 1	48	50	pF
Comparator 2	39	48	
VCO	61	53	

APPLICATION INFORMATION

This information is a guide for the approximation of values of external components to be used with the 74HC/HCT7046A in a phase-lock-loop system.

References should be made to Fig. 11 through 21 and 27 through 32 as indicated in the table.

Values of the selected components should be within the following ranges:

- R1 > 3 kΩ;
- R2 > 3 kΩ;
- R1 || R2 parallel value > 2.7 kΩ;
- C1 greater than 40 pF.

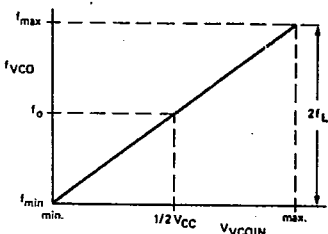
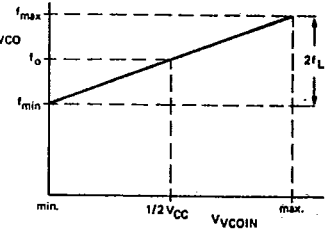
SUBJECT	PHASE COMPARATOR	DESIGN CONSIDERATIONS
VCO Frequency without extra offset (R2 = ∞)	PC1 or PC2	<p>VCO Frequency Characteristic The characteristics of the VCO operation are shown in Figs. 11-21.</p>  <p><i>Fig. 46 - Frequency characteristic of VCO operating without offset: f_o = center frequency; 2f_L = frequency lock range.</i></p>
	PC1	<p>Selection of R1 and C1 Given f_o, determine the values of R1 and C1 using Figs. 11-15.</p>
	PC2	<p>Given f_{max} and f_o, determine the values of R1 and C1 using Figs. 11-15. To obtain 2f_L: $2f_L \approx \frac{2(\Delta V_{COIN})}{R1C1}$ where 0.9 V < V_{COIN} < V_{CC} - 0.9 V is the range of ΔV_{COIN}</p>
VCO Frequency with extra offset (R2 > 3 kΩ)	PC1 or PC2	<p>VCO Frequency Characteristic The characteristics of the VCO operation are shown in Figs. 27-30.</p>  <p><i>Fig. 47 - Frequency characteristic of VCO operating with offset: f_o = center frequency; 2f_L = frequency lock range.</i></p>
	PC1 or PC2	<p>Selection of R1, R2 and C1 Given f_o and f_L, offset frequency, f_{min}, may be calculated from f_{min} ≈ f_o - 1.6 f_L. Obtain the values of C1 and R2 by using Figs. 27-30. Calculate the value of R1 from the value of C1 and the product R1C1.</p>

HARRIS SEMICONDUCTOR 27E D 430227J 0018178 4 HAS

CD54/74HC7046A
CD54/74HCT7046A

APPLICATION INFORMATION (Cont'd)

SUBJECT	PHASE COMPARATOR	DESIGN CONSIDERATIONS
PLL Conditions with No Signal at the SIG _{IN} Input	PC1	VCO adjusts to f_o with $\phi_{\text{DEMOUT}} = 90^\circ$ and $V_{\text{VCOIN}} = \frac{1}{2} V_{\text{CC}}$ (see Fig. 2).
	PC2	VCO adjusts to f_o with $\phi_{\text{DEMOUT}} = -360^\circ$ and $V_{\text{VCOIN}} = 0 \text{ V}$ (see Fig. 4).
PLL Frequency Capture Range	PC1 or PC2	<p>Loop Filter Component Selection</p> <p>(a) $\tau_1 = R3 \times C2$ (b) amplitude characteristic (c) pole-zero diagram A small capture range ($2f_o$) is obtained if $\tau > 2f_o \approx (1/\pi) (2\pi f_o / \tau_1)^{1/2}$ <i>Fig. 48 - Simple loop filter for PLL without offset.</i></p>
		<p>(a) $\tau_2 = R4 \times C2$; (b) amplitude characteristic (c) pole-zero diagram $\tau_3 = (R3 + R4) \times C2$ <i>Fig. 49 - Simple loop filter for PLL with offset.</i></p>
PLL Locks on Harmonics at Center Frequency	PC1	Yes
	PC2	No
Noise Rejection at Signal Input	PC1	High
	PC2	Low
AC Ripple Content When PLL is Locked	PC1	$f_r = 2f_i$, large ripple content at $\phi_{\text{DEMOUT}} = 90^\circ$
	PC2	$f_r = f_i$, small ripple content at $\phi_{\text{DEMOUT}} = 0^\circ$

Lock Detector Circuit

The lock detector feature is very useful in data synchronization, motor speed control, and demodulation. By adjusting the value of the lock detector capacitor so that the lock output will change slightly before actually losing lock, the designer can create an "early warning" indication allowing corrective measures to be implemented. The reverse is also true, especially with motor speed controls, generators, and

clutches that must be set up before actual lock occurs or disconnected during loss of lock.

When using phase comparator 1, the detector will only indicate a lock condition on the fundamental frequency and not on the harmonics, which PC1 will lock on.

HARRIS SEMICONDUCTOR 27E D 4302271 0018179 6 HAS