

Data sheet | Item number: 831-3103/107-000

1-conductor female connector; Push-in CAGE CLAMP®; 10 mm²; Pin spacing 7.62 mm; 3-pole; 100% protected against mismatching; Screw flange; 10,00 mm²; light gray

www.wago.com/831-3103/107-000

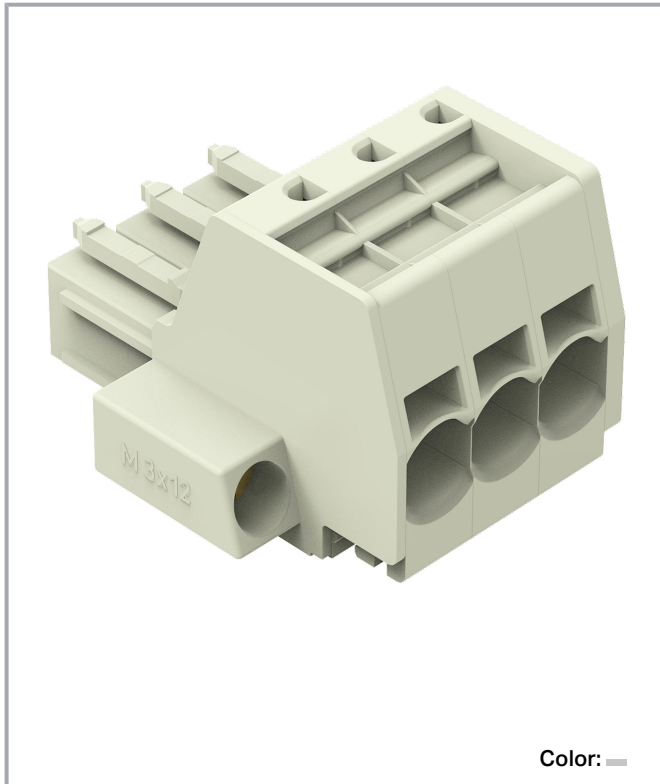

Color: —

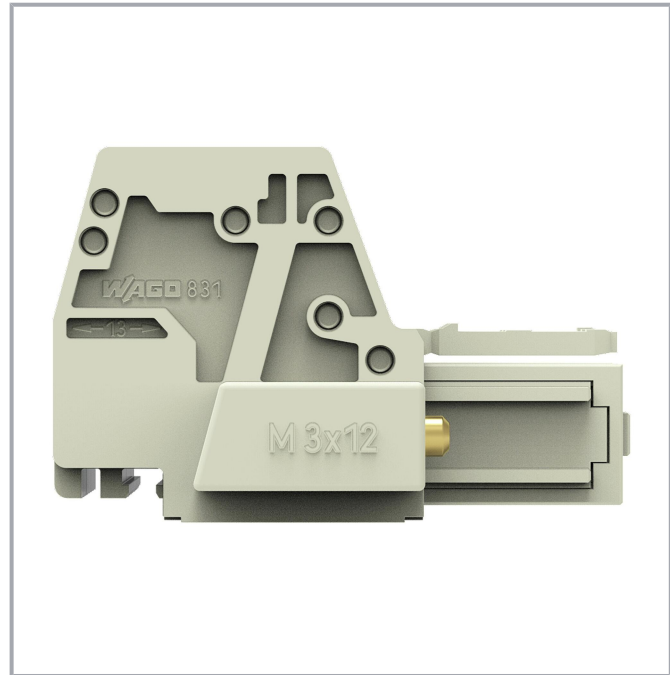

Subject to changes. Please also observe the further product documentation!

WAGO GmbH & Co. KG
Hansastr. 27
32423 Minden
Phone: +49571 887-0 | Fax: +49571 887-169
Email: info.de@wago.com | Web: www.wago.com

Do you have any questions about our products?
We are always happy to take your call at +49 (571) 887-44222.

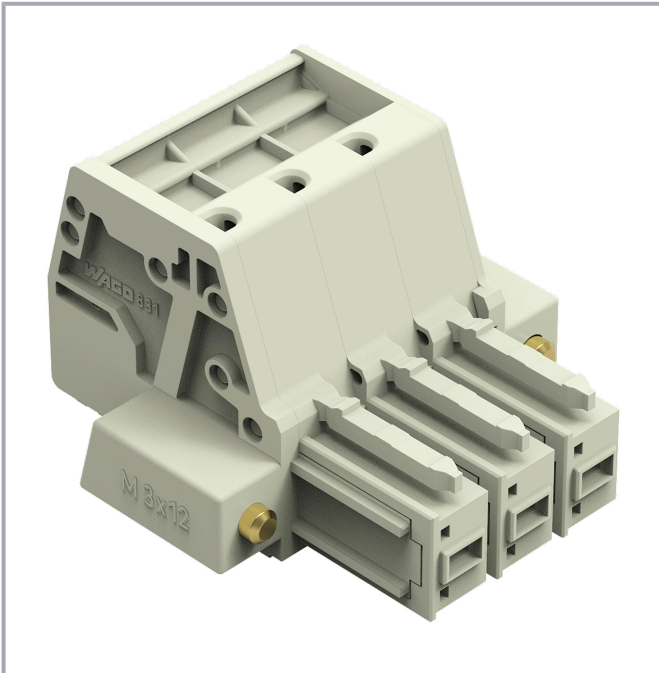

Derating Curve

1-conductor female connector (831-3102) with
THT male header (831-3622)

Pin spacing: 7.62 mm / Conductor cross-section: 10 mm² "f-st"
Based on: EN 60512-5-2 / Reduction factor: 0.8

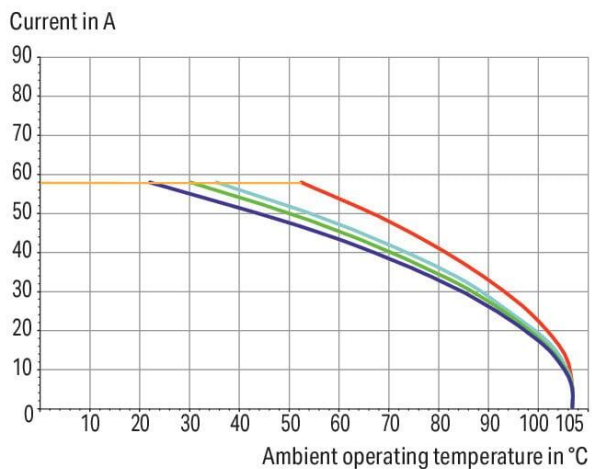

2-, 4-, 6-, 8- pole ——— Conductor rated current

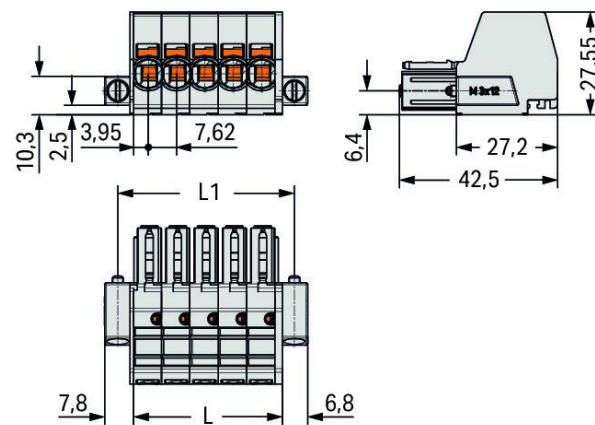

Dimensions in mm

$L = \text{pole no.} \times \text{pin spacing} + 1.9 \text{ mm}$

$L1 = L + 7.5 \text{ mm}$

Subject to changes. Please also observe the further product documentation!

WAGO GmbH & Co. KG
Hansastr. 27
32423 Minden
Phone: +49571 887-0 | Fax: +49571 887-169
Email: info.de@wago.com | Web: www.wago.com

Do you have any questions about our products?
We are always happy to take your call at +49 (571) 887-44222.



Item description

- Universal connection for all conductor types
- Push-in termination of solid or ferruled conductors
- Integrated test ports for 2 mm Ø test plugs
- 600 V UL per UL 1059
- 100 % protected against mismatching
- Coding via coding fingers

Data

Notes

Safety information

The *MCS – MULTI CONNECTION SYSTEM* includes connectors without breaking capacity in accordance with DIN EN 61984. When used as intended, these connectors must not be connected /disconnected when live or under load. When used as intended, these connectors must not be connected/disconnected when live or under load. The circuit design should ensure header pins, which can be touched, are not live when unmated.

Variants:

Other pole numbers

Other versions (or variants) can be requested from WAGO Sales or configured at <https://configurator.wago.com/>.

Electrical data

Ratings per IEC/EN

Ratings per	IEC/EN 60664-1
Nominal voltage (III/3)	800 V
Rated impulse voltage (III/3)	8 kV
Rated voltage (III/2)	1000 V
Rated impulse voltage (III/2)	8 kV
Nominal voltage (II/2)	1000 V
Rated surge voltage (II/2)	8 kV
Rated current	41 A
Legend (ratings)	(III / 2) ≙ Overvoltage category III / Pollution degree 2

Ratings per UL

Approvals per	UL 1059
---------------	---------

Subject to changes. Please also observe the further product documentation!

WAGO GmbH & Co. KG

Hansastr. 27

32423 Minden

Phone: +49571 887-0 | Fax: +49571 887-169

Email: info.de@wago.com | Web: www.wago.com

Do you have any questions about our products?

We are always happy to take your call at +49 (571) 887-44222.



Rated voltage UL (Use Group C)	600 V
Rated current UL (Use Group C)	42 A

Ratings per CSA

Approvals per	CSA
Rated voltage CSA (Use Group C)	600 V
Rated current CSA (Use Group C)	41 A

Connection data

Total number of potentials	3
Number of connection types	1
Number of levels	1

Connection 1

Connection technology	Push-in CAGE CLAMP®
Actuation type	Operating tool
Actuation direction 1	Operation parallel to conductor entry
Solid conductor	0.5 ... 10 mm ² / 20 ... 8 AWG
Fine-stranded conductor	0.5 ... 10 mm ² / 20 ... 8 AWG
Fine-stranded conductor; with insulated ferrule	0.5 ... 6 mm ²
Fine-stranded conductor; with uninsulated ferrule	0.5 ... 6 mm ²
Strip length	13 ... 15 mm / 0.51 ... 0.59 inches
Pole number	3
Conductor entry direction to mating direction	0°

Physical data

Pin spacing	7.62 mm / 0.3 inches
Width	39.4 mm / 1.550 inches
Height	27.6 mm / 1.087 inches
Depth	42.5 mm / 1.673 inches

Mechanical Data

Variable coding	Yes
Anti-rotation protection	Yes

Subject to changes. Please also observe the further product documentation!



Plug-in connection

Contact type (pluggable connector)	Female connector/socket
Connector (connection type)	for conductor
Mismatching protection	Yes
Plugging without loss of pin spacing	No
Locking of plug-in connection	Screw flange

Material data

Note (material data)

Information on material specifications can be found here

Color	light gray
Material group	I
Insulation material	Polyamide (PA66)
Flammability class per UL94	V0
Clamping spring material	Chrome-nickel spring steel (CrNi)
Material of the additional spring for socket contact	Chrome-nickel spring steel (CrNi)
Contact material	Electrolytic copper (E _{Cu})
Contact plating	Tin
Fire load	0.197 MJ
Weight	26.3 g

Environmental requirements

Limit temperature range	-60 ... +105 °C
Processing temperature	-35 ... +60 °C

Commercial data

ETIM 8.0	EC001284
ETIM 7.0	EC001284
Recupel Type	
ECCN	NO DATA
PU (SPU)	24 pcs
Country of origin	PL
GTIN	4066966091489
Customs tariff number	85366990990

Subject to changes. Please also observe the further product documentation!

WAGO GmbH & Co. KG
Hansastr. 27
32423 Minden
Phone: +49571 887-0 | Fax: +49571 887-169
Email: info.de@wago.com | Web: www.wago.com

Do you have any questions about our products?
We are always happy to take your call at +49 (571) 887-44222.



Environmental Product Compliance

RoHS Compliance Status

Compliant, No Exemption

Approvals / Certificates

General approvals

Logo	Approval	Additional Approval Text	Certificate name
	CB DEKRA Certification B.V.	IEC 61984	NL-61360 /M1
	KEMA/KEUR DEKRA Certification B.V.	EN 61984	71-116057
	UR Underwriters Laboratories Inc.	UL 1059	E45172

Counterpart



Item no. 831-3603/108-000

THT male header; 1.0 x 1.2 mm solder pin; straight; 100% protected against mismatching; Threaded flange; Pin spacing 7.62 mm; 3-pole; light gray

www.wago.com/831-3603/108-000



Item no. 831-3203/109-000

1-conductor male connector; Push-in CAGE CLAMP®; 10 mm²; Pin spacing 7.62 mm; 3-pole; 100% protected against mismatching; Threaded flange; 10,00 mm²; light gray

www.wago.com/831-3203/109-000



Item no. 831-3623/108-000

THT male header; 1.0 x 1.2 mm solder pin; angled; 100% protected against mismatching; Threaded flange; Pin spacing 7.62 mm; 3-pole; light gray

www.wago.com/831-3623/108-000

Optional accessories

Strain relief

Strain relief plate



Item no.: 831-506

Strain relief plate; for female and male connectors; 51 mm wide; 1 part; Pin spacing 7.62 mm; light gray

www.wago.com/831-506

Subject to changes. Please also observe the further product documentation!

WAGO GmbH & Co. KG

Hansastr. 27

32423 Minden

Phone: +49571 887-0 | Fax: +49571 887-169

Email: info.de@wago.com | Web: www.wago.com

Do you have any questions about our products?

We are always happy to take your call at +49 (571) 887-44222.



Downloads

Documentation

Additional Information

Technical Section	2019 Apr 3	pdf	Download
Technical explanations		2.1 MB	

CAD/CAE-Data

CAE data

ZUKEN Portal 831-3103/107-000	URL	Download
-------------------------------	-----	----------

CAD data

2D/3D Models 831-3103/107-000	URL	Download
-------------------------------	-----	----------

Asset Administration Shell

Asset Administration Shell 831-3103/107-000	URL	Download
---	-----	----------

Environmental Product Compliance

Compliance Search

Environmental Product Compliance 831-3103/107-000	URL	Download
---	-----	----------

1-conductor female connector; Push-in CAGE CLAMP®; 10 mm²; Pin spacing 7.62 mm; 3-pole; 100% protected against mismatching; Screw flange; 10,00 mm²; light gray

Installation Notes

Conductor termination

Subject to changes. Please also observe the further product documentation!

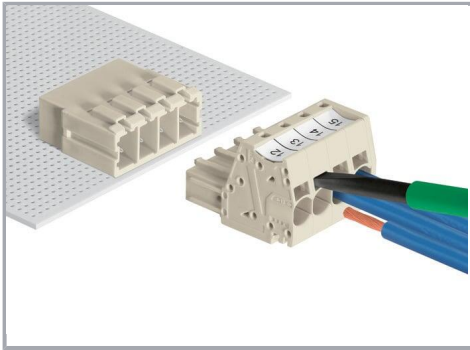

Inserting fine-stranded conductors via (5.5 x 0.8) mm screwdriver.

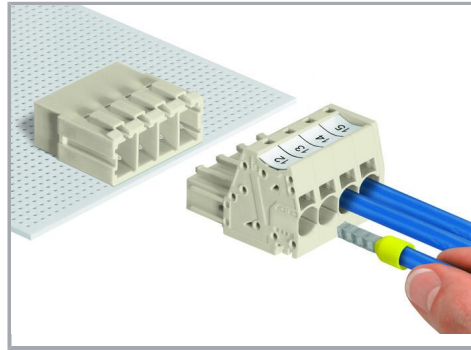

Solid and ferruled conductors are terminated by simply pushing them into unit.

Testing

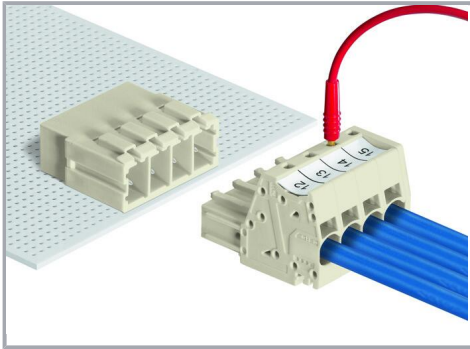

Testing with 2 mm Ø test plug.

Coding

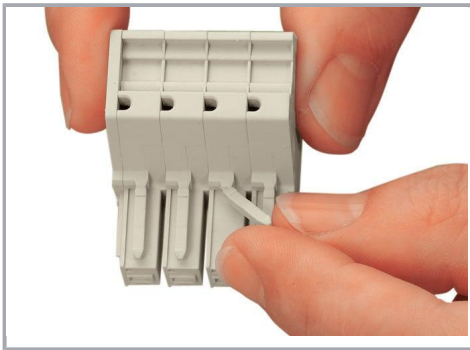

Break or cut off coding pin from female connector.

Marking

Subject to changes. Please also observe the further product documentation!



Direct marking of female and male connectors



MCS MAXI male and female connectors can also be marked via Mini-WSB or WMB markers.

Product family

MCS MAXI 6

[Show all products from the family](#)

Subject to changes. Please also observe the further product documentation!