

Data sheet | Item number: 770-744

Snap-in socket; 4-pole; Cod. B; 4,00 mm<sup>2</sup>; gray

[www.wago.com/770-744](http://www.wago.com/770-744)

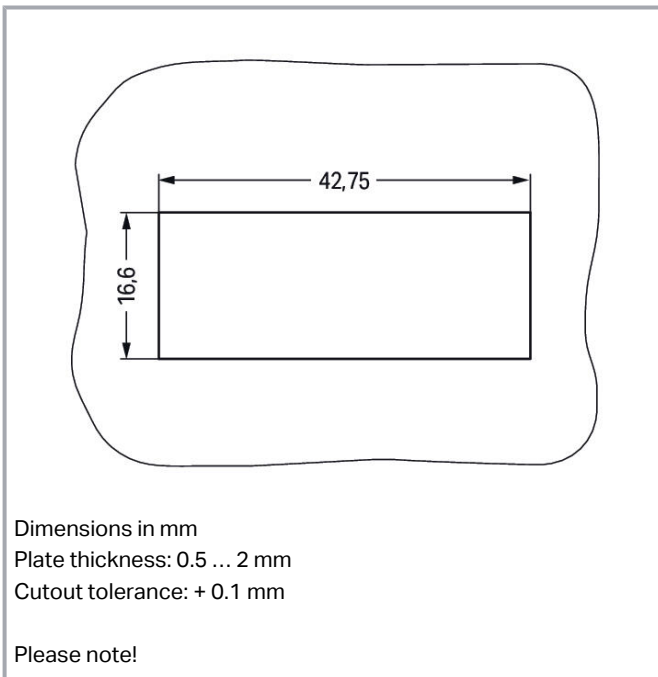
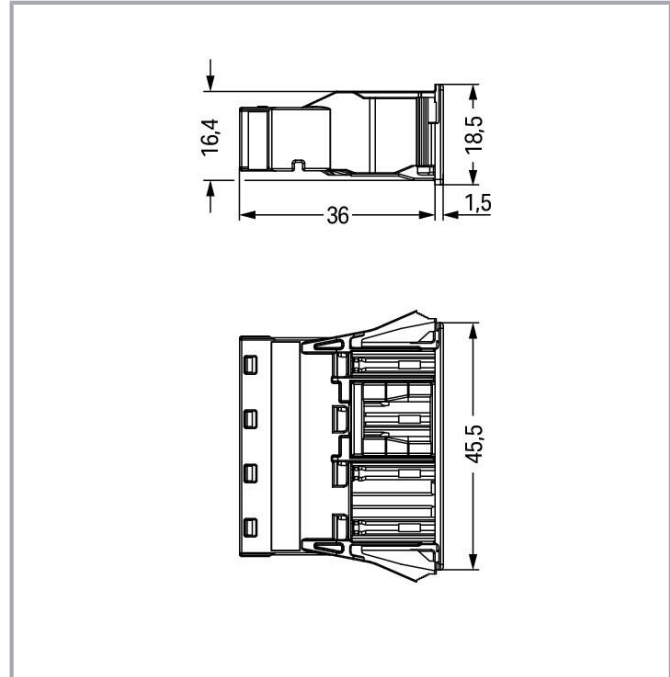
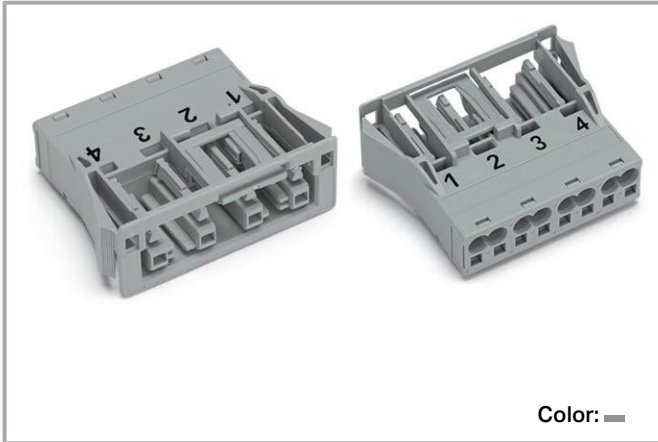

Dimensions in mm  
Plate thickness: 0.5 ... 2 mm  
Cutout tolerance: + 0.1 mm

Please note!

Subject to changes. Please also observe the further product documentation!

WAGO GmbH & Co. KG  
Hansastr. 27  
32423 Minden  
Phone: +49571 887-0 | Fax: +49571 887-169  
Email: [info.de@wago.com](mailto:info.de@wago.com) | Web: [www.wago.com](http://www.wago.com)

Do you have any questions about our products?  
We are always happy to take your call at +49 (571) 887-44222.



## Item description

### Female connector/socket WINSTA® MIDI B coding

The WINSTA® MIDI female connector/socket 4-pole supports fast, reliable installation. Whether on PCBs, in control cabinets or for connecting lights – pluggable installation connectors from WAGO allow you to establish connections according to various requirements in seconds. For greater protection in electrical installations, the pluggable installation connector is equipped with mechanical protection against mismatching. The pluggable installation connector offers touch-proof protection with live components in accordance with protection type IP20 (When mated: IP2xC (These compact connectors are not designed for use in open, easily accessible areas!)). B coding enables the WINSTA® MIDI pluggable installation connectors to be used for application control in the domains of automation, robotics, and mechanical engineering. Important parameters in the selection of a pluggable installation connector are the rated current and voltage: They provide information about possible domains of use and applications. This product has a current rating of 25 A – so it is also suitable for high power loads. The WINSTA® MIDI Pluggable Connection System with Push-in CAGE CLAMP® spring pressure connection technology facilitates safe electrification. Thanks to the built-in test slot, it is possible to check connections even when they are plugged in. That saves time and reduces installation labor and expense.

### Push-in CAGE CLAMP® spring pressure connection technology – pluggable installation instead of laborious screw connections!

The WINSTA® Pluggable Connection System is perfectly tailored to the strict requirements of building installation. It makes electrical installation pluggable, and therefore more efficient, more reliable, and error-free. Use of this pre-assembled system reduces assembly times and installation errors at the construction site. Now you can also cut installation expenses without compromising safety and quality: with locking lever reduces the need for servicing and prevents unnecessary downtime.

- 
- pluggable installation connectors with protection against mismatching
- pre-assembled versions
- with B coding for controllers, for example sun blinds and lighting fixtures
- ready for immediate use
- quick replacement of defective units during ongoing operation

## Data

### Notes

Note	<p>The snap-in connectors must be relieved of tensile and transverse forces.</p> <p>A surface finish can influence the edge radius of the cutouts. This may affect the snap-in socket fit, so ensure an adequate fit before use. In addition, the punched edge should be on the inside for punched cutouts.</p> <p>The wings of the snap-in connectors must not be mechanically</p>
------	---

Subject to changes. Please also observe the further product documentation!



stressed for a long period before use (e.g., due to a pre-locking position).

Variants:

Other pole markings

Other versions (or variants) can be requested from WAGO Sales or configured at <https://configurator.wago.com/>.

## Electrical data

### Ratings per IEC/EN

Ratings per	IEC/EN 60664-1
Nominal voltage (III/3)	400 V
Rated impulse voltage (III/3)	6 kV
Rated current	25 A
Legend (ratings)	(III / 3) ≙ Overvoltage category III / Pollution degree 3

### Ratings per IEC/EN – Notes

Note (rated current)

25 A for 3-pole load

20 A for 4-pole load

### Ratings per UL 1977

Note for the US market

Some versions may also be used for current interruption in accordance with the UL certificate in select applications with currents below 16 A and voltages up to 600 V. For further information, please contact your local sales office.

Rated voltage (UL 1977)	600 V
Rated current UL 1977	23 A

## General information

Note on contact resistance

approx. 1 mΩ of contact resistance

approx. 0.25 mΩ contact transition plug/socket

## Connection data

Connection points	8
Total number of potentials	4

### Connection 1

Connection technology

Push-in CAGE CLAMP®

Subject to changes. Please also observe the further product documentation!

WAGO GmbH & Co. KG

Hansastr. 27

32423 Minden

Phone: +49571 887-0 | Fax: +49571 887-169

Email: [info.de@wago.com](mailto:info.de@wago.com) | Web: [www.wago.com](http://www.wago.com)

Do you have any questions about our products?

We are always happy to take your call at +49 (571) 887-44222.



Actuation type	Operating tool Push-in
Nominal cross-section	4 mm <sup>2</sup> / 12 AWG
Solid conductor	0.5 ... 4 mm <sup>2</sup> / 20 ... 12 AWG
Solid conductor; push-in termination	1.5 ... 4 mm <sup>2</sup> / 16 ... 12 AWG
Stranded conductor	0.5 ... 2.5 mm <sup>2</sup> / 20 ... 14 AWG
Fine-stranded conductor	0.5 ... 4 mm <sup>2</sup> / 20 ... 12 AWG
Fine-stranded conductor; with insulated ferrule	0.25 ... 1.5 mm <sup>2</sup> / 20 ... 16 AWG
Fine-stranded conductor; with uninsulated ferrule	0.25 ... 2.5 mm <sup>2</sup> / 20 ... 14 AWG
Fine-stranded conductor; with ferrule; push-in termination	1.5 mm <sup>2</sup> / 16 AWG
Strip length	9 mm / 0.35 inches
Pole number	4
Conductor entry direction to mating direction	0°

### Physical data

Pin spacing	10 mm / 0.394 inches
Width	45.5 mm / 1.791 inches
Height	18.5 mm / 0.728 inches
Depth	37.5 mm / 1.476 inches

### Mechanical Data

Application	Control technology
Coding	B
Variable coding	Yes
Marking	1 2 3 4
Potential marking	1 2 3 4
Mating force of a plug-in connection	approx. 20 ... 70 N (depending on pole number)
Retention force of a plug-in connection	Locked: > 80 N
Unmating force of a plug-in connection	Unlocked: approx. 20 ... 70 N (depending on pole number)
Number of mating cycles	200, without resistive load
Housing sheet thickness	0.5 ... 2 mm / 0.02 ... 0.079 inches
Mounting type	Snap-in flange
Protection type	IP20; When mated: IP2xC (These compact connectors are not designed for use in open, easily accessible areas!)

### Plug-in connection

Contact type (pluggable connector)	Female connector/socket
------------------------------------	-------------------------

Subject to changes. Please also observe the further product documentation!



Connector (connection type)	for conductor
Mismating protection	Yes
Note on mismating protection	All <i>WINSTA</i> <sup>®</sup> components are 100% protected against mismating when: a.) plugging different numbers of poles b.) plugging while rotated 180 c.) plugging while laterally staggered d.) plugging one pole
Locking lever	yes
Locking of plug-in connection	locking lever
Note on locking system	All connectors for mounted installations (snap-in versions for lighting fixtures or devices, all types of PCB and distribution connectors) are factory-equipped with locking levers to ensure plugs and sockets are securely locked. Additional locking levers are only required for flying leads (plug/socket).

## Material data

Note (material data)	Information on material specifications can be found here
Color	gray
Insulation material	Polyamide (PA66)
Flammability class per UL94	V0
Clamping spring material	Chrome-nickel spring steel (CrNi)
Contact material	Copper or copper alloy; surface-treated
Contact plating	Tin
Fire load	0.4 MJ
Weight	15.6 g

## Environmental requirements

Processing temperature	-5 ... +40 °C
Continuous operating temperature	-35 ... +85 °C
Note on continuous operating temperature	Insulating parts for temperatures ≤ 105 °C

## Commercial data

eCl@ss 10.0	27-44-06-02
eCl@ss 9.0	27-44-06-02
ETIM 8.0	EC002566
ETIM 7.0	EC002566

Subject to changes. Please also observe the further product documentation!

WAGO GmbH & Co. KG  
Hansastr. 27  
32423 Minden  
Phone: +49571 887-0 | Fax: +49571 887-169  
Email: [info.de@wago.com](mailto:info.de@wago.com) | Web: [www.wago.com](http://www.wago.com)

Do you have any questions about our products?  
We are always happy to take your call at +49 (571) 887-44222.



ECCN	NO DATA
PU (SPU)	100 pcs
Packaging type	box
Country of origin	DE
GTIN	4044918252683
Customs tariff number	85366990990

## Environmental Product Compliance



RoHS Compliance Status	Compliant, No Exemption
------------------------	-------------------------

## Approvals / Certificates

### General approvals

Logo	Approval	Additional Approval Text	Certificate name
	CCA DEKRA Certification B.V.	IEC 61984	NL-32104
	CCA DEKRA Certification B.V.	EN 61984	2173495.01
	cURus Underwriters Laboratories Inc.	UL 1977	E45171
	cURus Underwriters Laboratories Inc.	UL 1059	E 45172

### Declarations of conformity and manufacturer's declarations



Logo	Approval	Additional Approval Text	Certificate name
	EU-Declaration of Conformity WAGO GmbH & Co. KG	-	-
	UK-Declaration of Conformity WAGO GmbH & Co. KG	-	-

### Approvals for marine applications



Subject to changes. Please also observe the further product documentation!

WAGO GmbH & Co. KG  
Hansastr. 27  
32423 Minden  
Phone: +49571 887-0 | Fax: +49571 887-169  
Email: [info.de@wago.com](mailto:info.de@wago.com) | Web: [www.wago.com](http://www.wago.com)



Do you have any questions about our products?  
We are always happy to take your call at +49 (571) 887-44222.

Logo	Approval	Additional Approval Text	Certificate name
	<b>ABS</b> American Bureau of Shipping	-	19- HG1868589- PDA
	<b>DNV GL</b> Det Norske Veritas, Germanischer Lloyd	-	TAE00001Z6
	<b>LR</b> Lloyds Register	IEC 61984	LR22429487TA

## Counterpart

	<b>Item no.770-254</b> Plug; 4-pole; Cod. B; 4,00 mm <sup>2</sup> ; gray	<a href="http://www.wago.com/770-254">www.wago.com/770-254</a>
	<b>Item no.771-9994/005-103</b> pre-assembled interconnecting cable; Eca; Socket/plug; 4-pole; Cod. B; Control cable 4 x 1.0 mm <sup>2</sup> ; 1 m; 1,00 mm <sup>2</sup> ; gray	<a href="http://www.wago.com/771-9994/005-103">www.wago.com/771-9994/005-103</a>
	<b>Item no.771-9994/205-103</b> pre-assembled connecting cable; Eca; Plug/open-ended; 4-pole; Cod. B; Control cable 4 x 1.0 mm <sup>2</sup> ; 1 m; 1,00 mm <sup>2</sup> ; gray	<a href="http://www.wago.com/771-9994/205-103">www.wago.com/771-9994/205-103</a>

## Optional accessories

Cover		
	<b>Item no.: 770-694</b> Lockout cap; 4-pole; for cutouts; Plastic; white	<a href="http://www.wago.com/770-694">www.wago.com/770-694</a>
	<b>Item no.: 770-644</b> Lockout cap; 4-pole; for cutouts; Plastic; black	<a href="http://www.wago.com/770-644">www.wago.com/770-644</a>
	<b>Item no.: 770-201</b> Lockout cap; 12-pole, separable; for sockets; Plastic; black	<a href="http://www.wago.com/770-201">www.wago.com/770-201</a>
	<b>Item no.: 770-221</b> Lockout cap; 12-pole, separable; for sockets; Plastic; white	<a href="http://www.wago.com/770-221">www.wago.com/770-221</a>

Tool		
Operating tool		

Subject to changes. Please also observe the further product documentation!



Item no.: 210-719

Operating tool; Blade: 2.5 x 0.4 mm; with a partially insulated shaft

[www.wago.com/210-719](http://www.wago.com/210-719)

## Downloads

### Documentation

#### Bid Text

770-744 X81 - Datei	2019 Feb 19	xml 3.0 kB	Download
------------------------	-------------	---------------	----------

770-744 doc - Datei	2015 Jun 8	doc 24.1 kB	Download
------------------------	------------	----------------	----------

### CAD/CAE-Data

#### CAD data

2D/3D Models 770-744		URL	Download
----------------------	--	-----	----------

#### CAE data

EPLAN Data Portal 770-744		URL	Download
---------------------------	--	-----	----------

WSCAD Universe 770-744		URL	Download
------------------------	--	-----	----------

ZUKEN Portal 770-744		URL	Download
----------------------	--	-----	----------

#### Asset Administration Shell

Asset Administration Shell 770-744		URL	Download
------------------------------------	--	-----	----------

### Environmental Product Compliance

#### Compliance Search

Environmental Product Compliance 770-744 Snap-in socket; 4-pole; Cod. B; 4,00 mm <sup>2</sup> ; gray		URL	Download
---	--	-----	----------

Subject to changes. Please also observe the further product documentation!



## Installation Notes

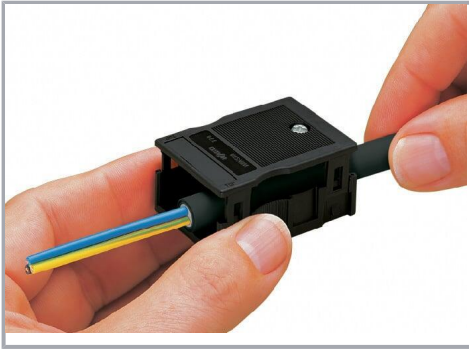

We recommend pulling the pre-latched strain relief housing over the cable prior to termination. However, the strain relief can be mounted at a later time as well.

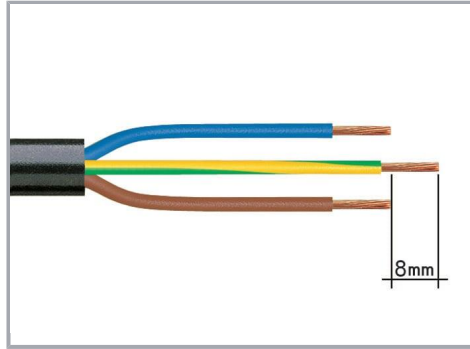

1. Strip length, outer insulation = 35 mm (2-pole), 55 mm (3- to 5-pole)
2. Strip length = 9 mm
3. Extended ground conductor = 8 mm

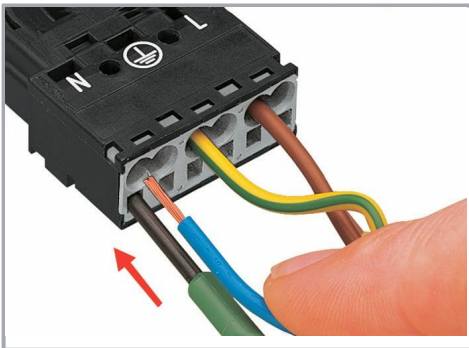

To terminate fine-stranded conductors, open the clamping unit via screwdriver (2.5 mm blade width) and insert a stripped conductor until it hits the backstop.

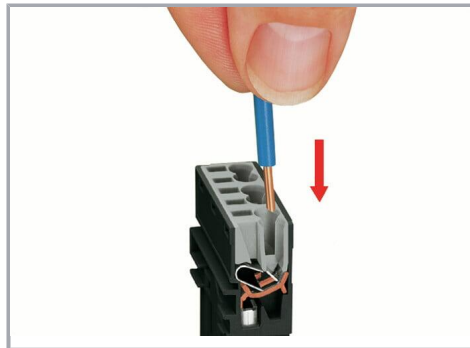

Insert the stripped solid conductor until it hits the backstop.

Subject to changes. Please also observe the further product documentation!

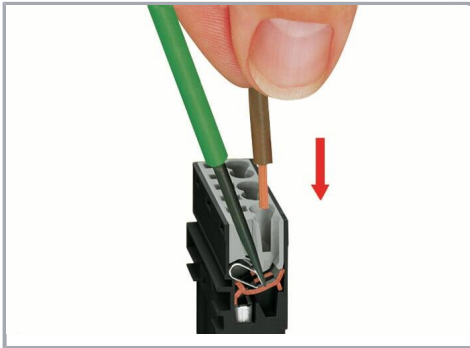

To terminate fine-stranded conductors, open the clamping unit via screwdriver (2.5 mm blade width) and insert a stripped conductor until it hits the backstop.

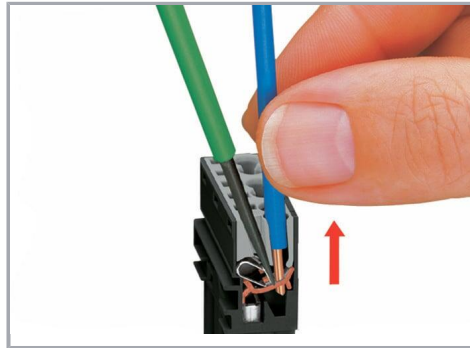

To remove the conductor, actuate the clamp via screwdriver (2.5 mm blade width) and pull out the conductor.

## Product family

**WINSTA® MIDI**

[Show all products from the family](#)

Subject to changes. Please also observe the further product documentation!