

Data sheet | Item number: 713-1110/037-000

1-conductor female connector, 2-row; CAGE CLAMP®; 1.5 mm²; Pin spacing 3.5 mm; 20-pole; 100% protected against mismatching; Levers; 1,50 mm²; black



www.wago.com/713-1110/037-000



i Picture differs from the item.

Color: ■

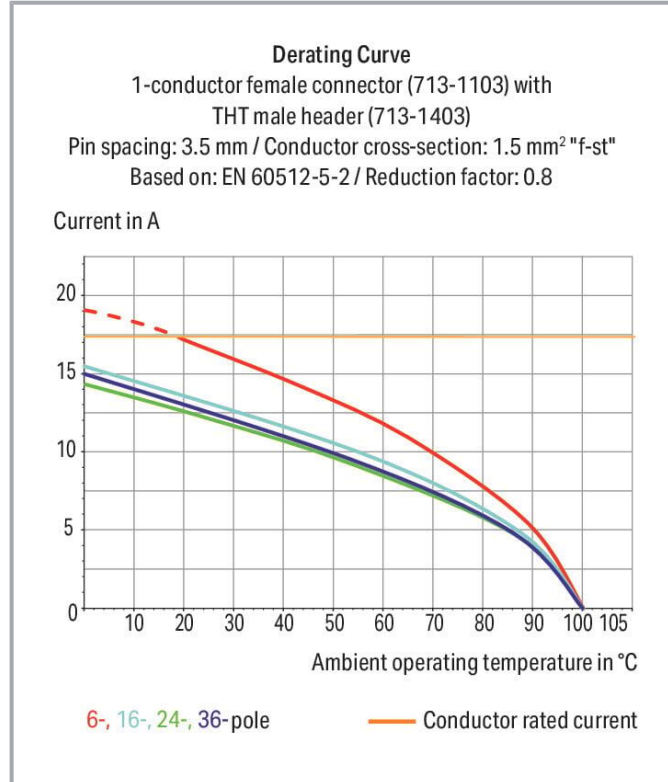

Subject to changes. Please also observe the further product documentation!

WAGO GmbH & Co. KG
Hansastr. 27
32423 Minden
Phone: +49571 887-0 | Fax: +49571 887-169
Email: info.de@wago.com | Web: www.wago.com

Do you have any questions about our products?
We are always happy to take your call at +49 (571) 887-44222.

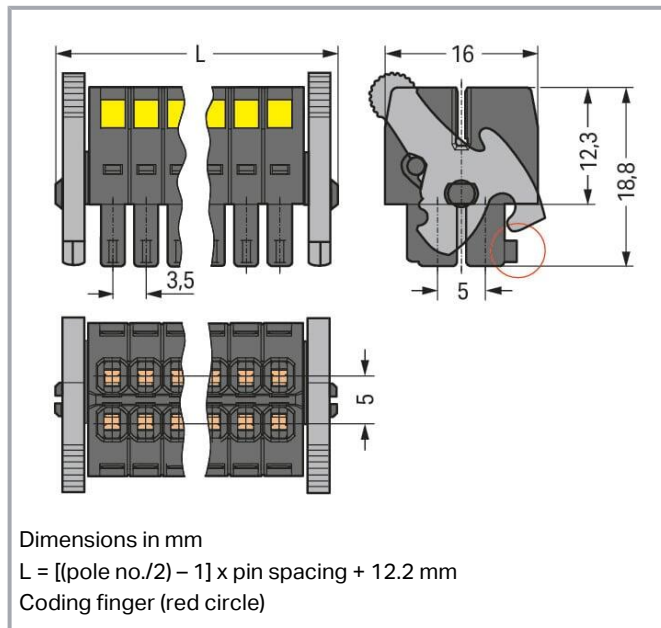

Item description

- Universal connection for all conductor types
- Unique, compact, double-row connector system for conductor cross-sections up to 1.5 mm²
- High-density, wire-to-board connections in very confined spaces
- Centered strain relief plate anchors conductors, while acting as convenient connection and disconnection handle. It also provides easy access to operating slots – even when wired.
- Coding fingers provide 100% protection against mismatching

Data

Notes

Safety information

The *MCS – MULTI CONNECTION SYSTEM* includes connectors without breaking capacity in accordance with DIN EN 61984. When used as intended, these connectors must not be connected /disconnected when live or under load. When used as intended, these connectors must not be connected/disconnected when live or under load. The circuit design should ensure header pins, which can be touched, are not live when unmated.

Variants:

Other pole numbers
 Gold-plated or partially gold-plated contact surfaces
 Other versions (or variants) can be requested from WAGO Sales or configured at <https://configurator.wago.com/>.

Subject to changes. Please also observe the further product documentation!

WAGO GmbH & Co. KG

Hansastr. 27

32423 Minden

Phone: +49571 887-0 | Fax: +49571 887-169

Email: info.de@wago.com | Web: www.wago.com

Do you have any questions about our products?

We are always happy to take your call at +49 (571) 887-44222.

Electrical data

Ratings per IEC/EN

Ratings per	IEC/EN 60664-1
Nominal voltage (III/3)	80 V
Rated impulse voltage (III/3)	2.5 kV
Rated voltage (III/2)	160 V
Rated impulse voltage (III/2)	2.5 kV
Nominal voltage (II/2)	250 V
Rated surge voltage (II/2)	2.5 kV
Rated current	10 A
Legend (ratings)	(III / 2) $\hat{=}$ Overvoltage category III / Pollution degree 2

Ratings per UL

Approvals per	UL 1059
Rated voltage UL (Use Group B)	300 V
Rated current UL (Use Group B)	10 A
Rated voltage UL (Use Group C)	50 V
Rated current UL (Use Group C)	10 A

Ratings per CSA

Approvals per	CSA
Rated voltage CSA (Use Group B)	300 V
Rated current CSA (Use Group B)	10 A

Connection data

Connection points	20
Total number of potentials	20
Number of connection types	1
Number of levels	2

Connection 1

Connection technology	CAGE CLAMP [®]
Actuation type	Operating tool
Actuation direction 1	Operation perpendicular to conductor entry
Solid conductor	0.08 ... 1.5 mm ² / 28 ... 16 AWG

Subject to changes. Please also observe the further product documentation!



Fine-stranded conductor	0.08 ... 1.5 mm ² / 28 ... 16 AWG
Fine-stranded conductor; with insulated ferrule	0.25 ... 1 mm ²
Fine-stranded conductor; with uninsulated ferrule	0.25 ... 1 mm ²
Strip length	6 ... 7 mm / 0.24 ... 0.28 inches
Pole number	20
Conductor entry direction to mating direction	0°

Physical data

Pin spacing	3.5 mm / 0.138 inches
Width	43.5 mm / 1.713 inches
Height	18.8 mm / 0.74 inches
Depth	16 mm / 0.63 inches

Mechanical Data

Variable coding	Yes
Anti-rotation protection	Yes

Plug-in connection

Contact type (pluggable connector)	Female connector/socket
Connector (connection type)	for conductor
Mismating protection	Yes
Plugging without loss of pin spacing	No
Locking of plug-in connection	Locking lever

Material data

Note (material data)	Information on material specifications can be found here
Color	black
Material group	II
Insulation material	Glass fiber-reinforced polyamide (PA66 GF)
Flammability class per UL94	V0
Clamping spring material	Chrome-nickel spring steel (CrNi)
Contact material	Copper alloy
Contact plating	Tin
Fire load	0.154 MJ
Weight	11.2 g

Subject to changes. Please also observe the further product documentation!



Environmental requirements

Limit temperature range	-60 ... +100 °C
Processing temperature	-35 ... +60 °C

Commercial data

Product Group	3 (Multi Conn. System)
eCl@ss 10.0	27-14-11-06
eCl@ss 9.0	27-14-11-06
ETIM 8.0	EC001284
ETIM 7.0	EC001284
ECCN	NO DATA
PU (SPU)	25 pcs
Packaging type	box
Country of origin	PL
GTIN	4055143625159
Customs tariff number	85366990990

Environmental Product Compliance

CAS-No.	131651-65-5 144317-44-2 220133-51-7 220689-12-3 25628-08-4 29420-49-3 375-73-5 503155-89-3 507453-86-3 68259-10-9
REACH Candidate List Substance	Perfluorobutane sulfonic acid (PFBS) and its salts
RoHS Compliance Status	Compliant,With Exemption
RoHS Exemption	6(c) 7(a) 7(c)-I 7(c)-II
SCIP notification number (Austria)	6c0220c9-0c06-4cc4-98c9-f44d555813dc
SCIP notification number (Belgium)	6796ee62-77c7-411b-b9a3-33bdcd177882
SCIP notification number (Bulgaria)	f4f14aa3-a338-4a3c-b6c1-67d418d7c6a3
SCIP notification number (Czech Republic)	7ca0bcdc-7881-45f6-893a-79e8a44723ca
SCIP notification number (Denmark)	1c56e6a0-2f7c-466a-a8c6-e1d2a055dc27

Subject to changes. Please also observe the further product documentation!



WAGO GmbH & Co. KG
Hansastr. 27
32423 Minden
Phone: +49571 887-0 | Fax: +49571 887-169
Email: info.de@wago.com | Web: www.wago.com

Do you have any questions about our products?
We are always happy to take your call at +49 (571) 887-44222.



SCIP notification number (Finland)	11904e5b-41ae-4c13-b289-c8e83dc3bf70
SCIP notification number (France)	a76b4197-d9a3-4e3f-85e3-4cd244c1a2e2
SCIP notification number (Germany)	fd0ce6de-df70-44d9-b73e-d7c126aeb76f
SCIP notification number (Hungary)	04f91789-4a62-430f-805d-3352965ef94b
SCIP notification number (Italy)	e5c68907-76e3-48ea-b56c-59de47a8aa28
SCIP notification number (Netherlands)	87e9d752-ae50-4ba9-9b20-a72a894fcee7
SCIP notification number (Poland)	91239731-d7bb-4118-9827-95008f5e2fe2
SCIP notification number (Romania)	61f65d40-5692-4657-a53d-cfde13cc5f52
SCIP notification number (Sweden)	2faab6ed-85d4-4a13-96e4-afbc0142dce5

Approvals / Certificates

General approvals

Logo	Approval	Additional Approval Text	Certificate name
	CSA CSA Group	C22.2	2315087
	KEMA/KEUR DEKRA Certification B.V.	EN 61984	71- 126089
	UR Underwriters Laboratories Inc.	UL 1059	E45172











Counterpart

	Item no.713-1410/037-000 THT male header, 2-row; 0.8 x 0.8 mm solder pin; straight; 100% protected against mismatching; Levers; Pin spacing 3.5 mm; 20-pole; black	www.wago.com/713-1410/037-000
	Item no.713-1410/116-000/997-408 THR male header, 2-row; 0.8 x 0.8 mm solder pin; straight; 100% protected against mismatching; Levers; in tape-and-reel packaging; Pin spacing 3.5 mm; 20-pole; black	www.wago.com/713-1410/116-000/997-408
	Item no.713-1410/116-000 THR male header, 2-row; 0.8 x 0.8 mm solder pin; straight; 100% protected against mismatching; Levers; Pin spacing 3.5 mm; 20-pole; black	www.wago.com/713-1410/116-000
	Item no.713-1430/037-000	

Subject to changes. Please also observe the further product documentation!

	THT male header, 2-row; 0.8 x 0.8 mm solder pin; angled; 100% protected against mismatching; Levers; Pin spacing 3.5 mm; 20-pole; black	www.wago.com/713-1430/037-000
	Item no.713-1430/116-000 THR male header, 2-row; 0.8 x 0.8 mm solder pin; angled; 100% protected against mismatching; Levers; Pin spacing 3.5 mm; 20-pole; black	www.wago.com/713-1430/116-000
	Item no.713-1430/116-000/997-408 THR male header, 2-row; 0.8 x 0.8 mm solder pin; angled; 100% protected against mismatching; Levers; in tape-and-reel packaging; Pin spacing 3.5 mm; 20-pole; black	www.wago.com/713-1430/116-000/997-408
	Item no.713-1470/037-000 THT male header, 2-row; 0.8 x 0.8 mm solder pin; straight; 100% protected against mismatching; with orientation nose; Levers; Pin spacing 3.5 mm; 20-pole; black	www.wago.com/713-1470/037-000

Optional accessories

Ferrule		
Ferrule		
	Item no.: 216-101 Ferrule; Sleeve for 0.5 mm ² / AWG 22; uninsulated; electro-tin plated; silver-colored	www.wago.com/216-101
	Item no.: 216-102 Ferrule; Sleeve for 0.75 mm ² / AWG 20; uninsulated; electro-tin plated; silver-colored	www.wago.com/216-102
	Item no.: 216-103 Ferrule; Sleeve for 1 mm ² / AWG 18; uninsulated; electro-tin plated	www.wago.com/216-103
	Item no.: 216-123 Ferrule; Sleeve for 1 mm ² / AWG 18; uninsulated; electro-tin plated; silver-colored	www.wago.com/216-123
	Item no.: 216-122 Ferrule; Sleeve for 0.75 mm ² / AWG 20; uninsulated; electro-tin plated; silver-colored	www.wago.com/216-122
	Item no.: 216-142 Ferrule; Sleeve for 0.75 mm ² / 18 AWG; uninsulated; electro-tin plated; electrolytic copper; gastight crimped; acc. to DIN 46228, Part 1/08.92	www.wago.com/216-142
	Item no.: 216-132 Ferrule; Sleeve for 0.34 mm ² / AWG 24; uninsulated; electro-tin plated	www.wago.com/216-132
	Item no.: 216-121 Ferrule; Sleeve for 0.5 mm ² / AWG 22; uninsulated; electro-tin plated; silver-colored	www.wago.com/216-121
	Item no.: 216-143 Ferrule; Sleeve for 1 mm ² / AWG 18; uninsulated; electro-tin plated; electrolytic copper; gastight crimped; acc. to DIN 46228, Part 1/08.92	www.wago.com/216-143
	Item no.: 216-131 Ferrule; Sleeve for 0.25 mm ² / AWG 24; uninsulated; electro-tin plated; silver-colored	www.wago.com/216-131
	Item no.: 216-141	

Subject to changes. Please also observe the further product documentation!



	Ferrule; Sleeve for 0.5 mm ² / 20 AWG; uninsulated; electro-tin plated; electrolytic copper; gastight crimped; acc. to DIN 46228, Part 1/08.92	www.wago.com/216-141
1	Item no.: 216-152 Ferrule; Sleeve for 0.34 mm ² / AWG 24; uninsulated; electro-tin plated	www.wago.com/216-152
	Item no.: 216-203 Ferrule; Sleeve for 1 mm ² / AWG 18; insulated; electro-tin plated; red	www.wago.com/216-203
	Item no.: 216-202 Ferrule; Sleeve for 0.75 mm ² / 18 AWG; insulated; electro-tin plated; gray	www.wago.com/216-202
1	Item no.: 216-151 Ferrule; Sleeve for 0.25 mm ² / AWG 24; uninsulated; electro-tin plated	www.wago.com/216-151
	Item no.: 216-201 Ferrule; Sleeve for 0.5 mm ² / 20 AWG; insulated; electro-tin plated; white	www.wago.com/216-201
	Item no.: 216-223 Ferrule; Sleeve for 1 mm ² / AWG 18; insulated; electro-tin plated; red	www.wago.com/216-223
	Item no.: 216-241 Ferrule; Sleeve for 0.5 mm ² / 20 AWG; insulated; electro-tin plated; electrolytic copper; gastight crimped; acc. to DIN 46228, Part 4/09.90; white	www.wago.com/216-241
	Item no.: 216-242 Ferrule; Sleeve for 0.75 mm ² / 18 AWG; insulated; electro-tin plated; electrolytic copper; gastight crimped; acc. to DIN 46228, Part 4/09.90; gray	www.wago.com/216-242
	Item no.: 216-222 Ferrule; Sleeve for 0.75 mm ² / 18 AWG; insulated; electro-tin plated; gray	www.wago.com/216-222
	Item no.: 216-221 Ferrule; Sleeve for 0.5 mm ² / 20 AWG; insulated; electro-tin plated; white	www.wago.com/216-221
	Item no.: 216-243 Ferrule; Sleeve for 1 mm ² / AWG 18; insulated; electro-tin plated; electrolytic copper; gastight crimped; acc. to DIN 46228, Part 4/09.90; red	www.wago.com/216-243
	Item no.: 216-263 Ferrule; Sleeve for 1 mm ² / AWG 18; insulated; electro-tin plated; electrolytic copper; gastight crimped; acc. to DIN 46228, Part 4/09.90; red	www.wago.com/216-263
	Item no.: 216-262 Ferrule; Sleeve for 0.75 mm ² / 18 AWG; insulated; electro-tin plated; electrolytic copper; gastight crimped; acc. to DIN 46228, Part 4/09.90; gray	www.wago.com/216-262
	Item no.: 216-301 Ferrule; Sleeve for 0.25 mm ² / AWG 24; insulated; electro-tin plated; yellow	www.wago.com/216-301
	Item no.: 216-321 Ferrule; Sleeve for 0.25 mm ² / AWG 24; insulated; electro-tin plated; yellow	www.wago.com/216-321
	Item no.: 216-322 Ferrule; Sleeve for 0.34 mm ² / 22 AWG; insulated; electro-tin plated; light turquoise	www.wago.com/216-322
	Item no.: 216-302	www.wago.com/216-302

Subject to changes. Please also observe the further product documentation!

Ferrule; Sleeve for 0.34 mm² / 22 AWG; insulated; electro-tin plated; light turquoise

Tool

Operating tool



Item no.: 210-647

Operating tool; Blade: 2.5 x 0.4 mm; with a partially insulated shaft; multicoloured

www.wago.com/210-647



Item no.: 210-719

Operating tool; Blade: 2.5 x 0.4 mm; with a partially insulated shaft

www.wago.com/210-719

Strain relief

Strain relief plate



Item no.: 713-127

Strain relief plate; for female connectors; 25 mm wide; 1 part; Pin spacing 3.5 mm; black

www.wago.com/713-127

Downloads

Documentation

Additional Information

Technical Section	2019 Apr 3	pdf	Download
Technical explanations		2.1 MB	

CAD/CAE-Data

CAD data

2D/3D Models 713-1110/037-000	URL	Download
-------------------------------	-----	----------

CAE data

ZUKEN Portal 713-1110/037-000	URL	Download
-------------------------------	-----	----------

Asset Administration Shell

Asset Administration Shell 713-1110/037-000	URL	Download
---	-----	----------

Environmental Product Compliance

Compliance Search

Environmental Product Compliance 713-1110/037-000	URL	Download
---	-----	----------

Subject to changes. Please also observe the further product documentation!

1-conductor female connector, 2-row; CAGE CLAMP®; 1.5 mm²; Pin spacing 3.5 mm;
20-pole; 100% protected against mismatching; Levers; 1,50 mm²; black

Installation Notes

Conductor termination

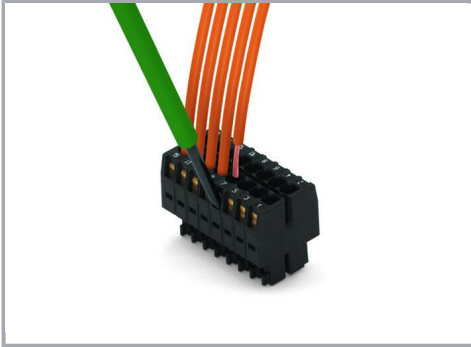

Inserting a conductor via (2.5 x 0.4) mm screwdriver.

Locking system

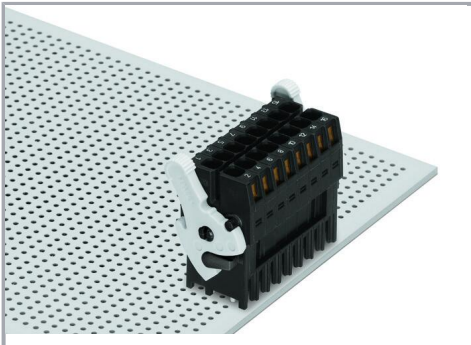

Lever as a lock – when closed, female connector is locked.

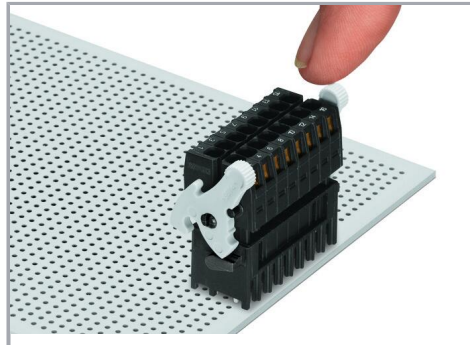

Lever as a disconnection aid – when opened, female connector is disconnected. Rotating the lever lifts the female connector out of the male header.

Subject to changes. Please also observe the further product documentation!

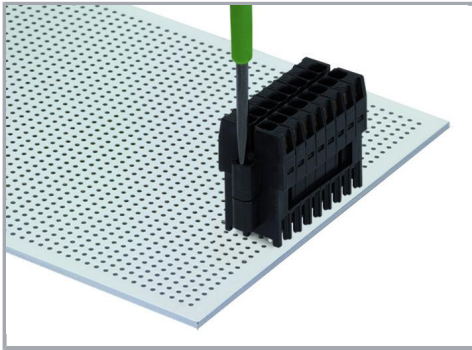

Screw interlock can only be disconnected using a tool.

Coding

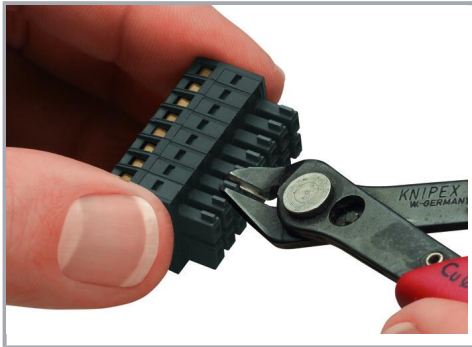

Coding a female connector by removing coding finger(s).

Strain relief

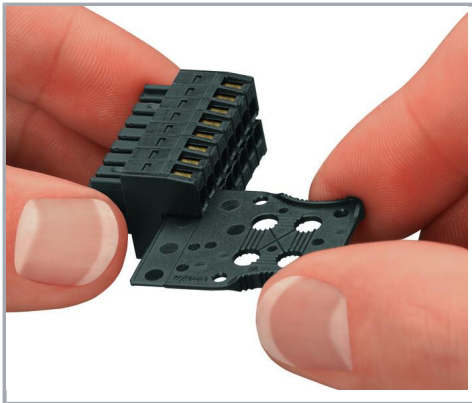

Strain relief plate for field assembly

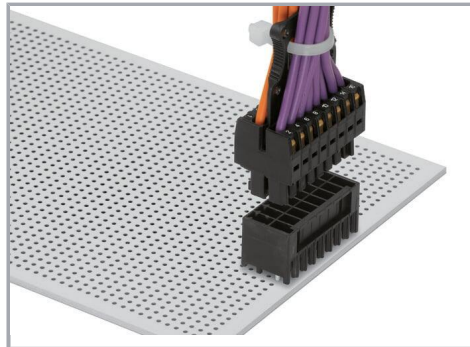

Centered strain relief plate anchors conductors for easy disconnection.

Product family

MCS MINI HD

Subject to changes. Please also observe the further product documentation!



[Show all products from the family](#)

Subject to changes. Please also observe the further product documentation!

WAGO GmbH & Co. KG
Hansastr. 27
32423 Minden
Phone: +49571 887-0 | Fax: +49571 887-169
Email: info.de@wago.com | Web: www.wago.com

Do you have any questions about our products?
We are always happy to take your call at +49 (571) 887-44222.